

Wiring diagram

NIBE

NIBE F1145PC /F1245PC

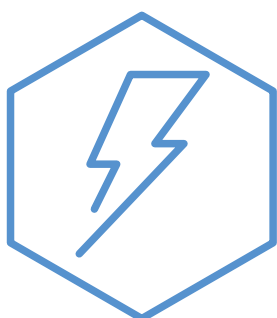

WHB EN 2451-1
831482

Table of Contents

3x400V 6-10 kW _____ 4

3X400V 6-10 KW

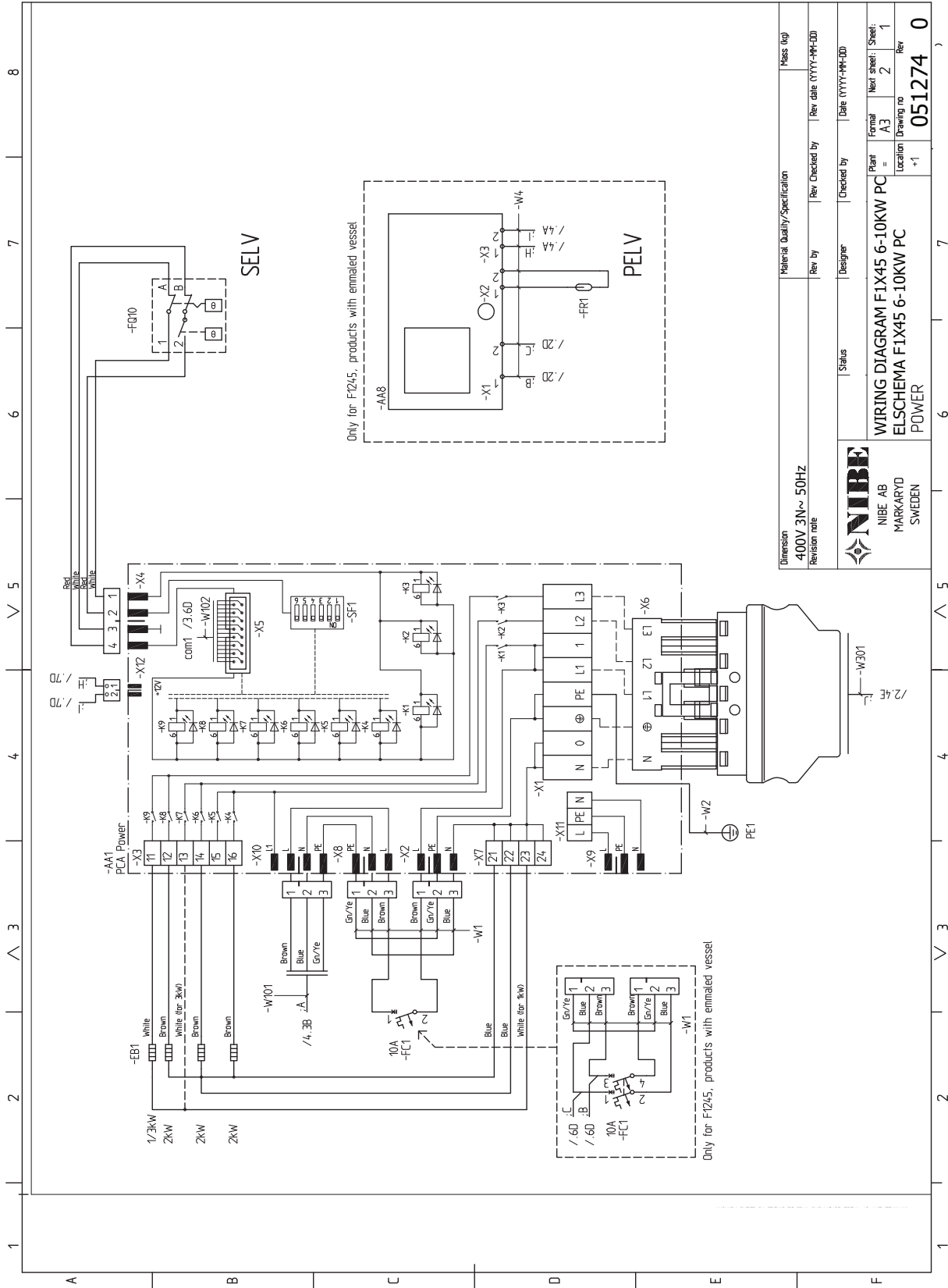

Dimension	Material Quality/Specification	Mass (kg)
400V 3N~ 50Hz		
Revision title	Rev. by	Rev. Checked by
	Designer	Checked by
	Status	Date (YYYY-MM-DD)
 NIBE AB MARKARYD SWEDEN	Plant	Formal Sheet:
	WIRING DIAGRAM FIX45 6-10KW PC	A3 = 2 1
	ELSCHEMA FIX45 6-10KW PC	Location Drawing no
POWER	+1	Rev
		051274
		0

3X400V 6-10 KW

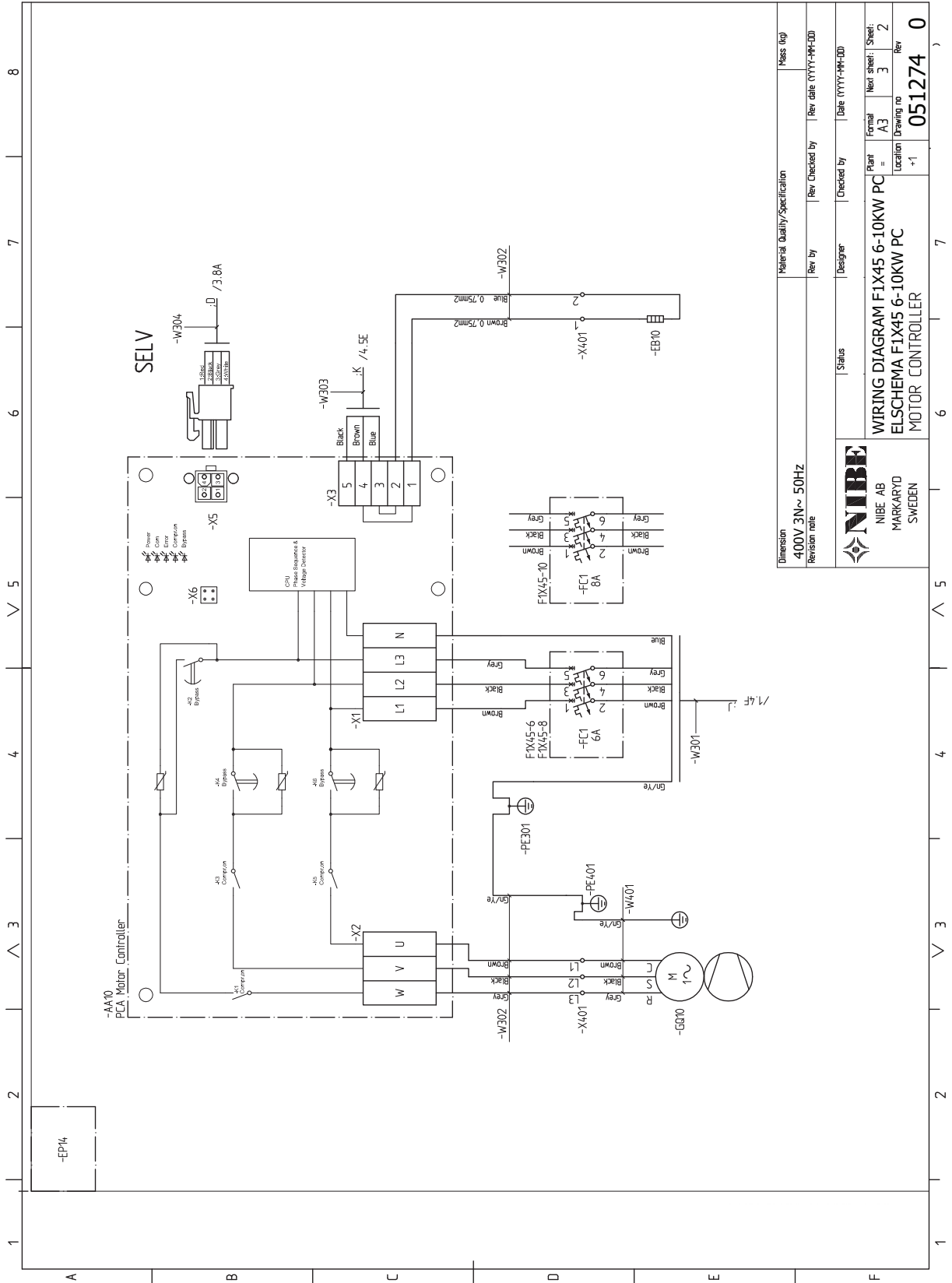

Dimension	Material Quality/Specification	Mass (kg)
400V 3N~ 50Hz		
Revision note	Rev. by	Rev. Checked by
	Designer	Checked by
	Status	Date (YYYY-MM-DD)
NIBE	Plant	Formal Sheet
NIBE AB	=	A3
MARKARYD	Location	Drawing no
SWEDEN	+1	051274
		Rev
		0

3X400V 6-10 KW

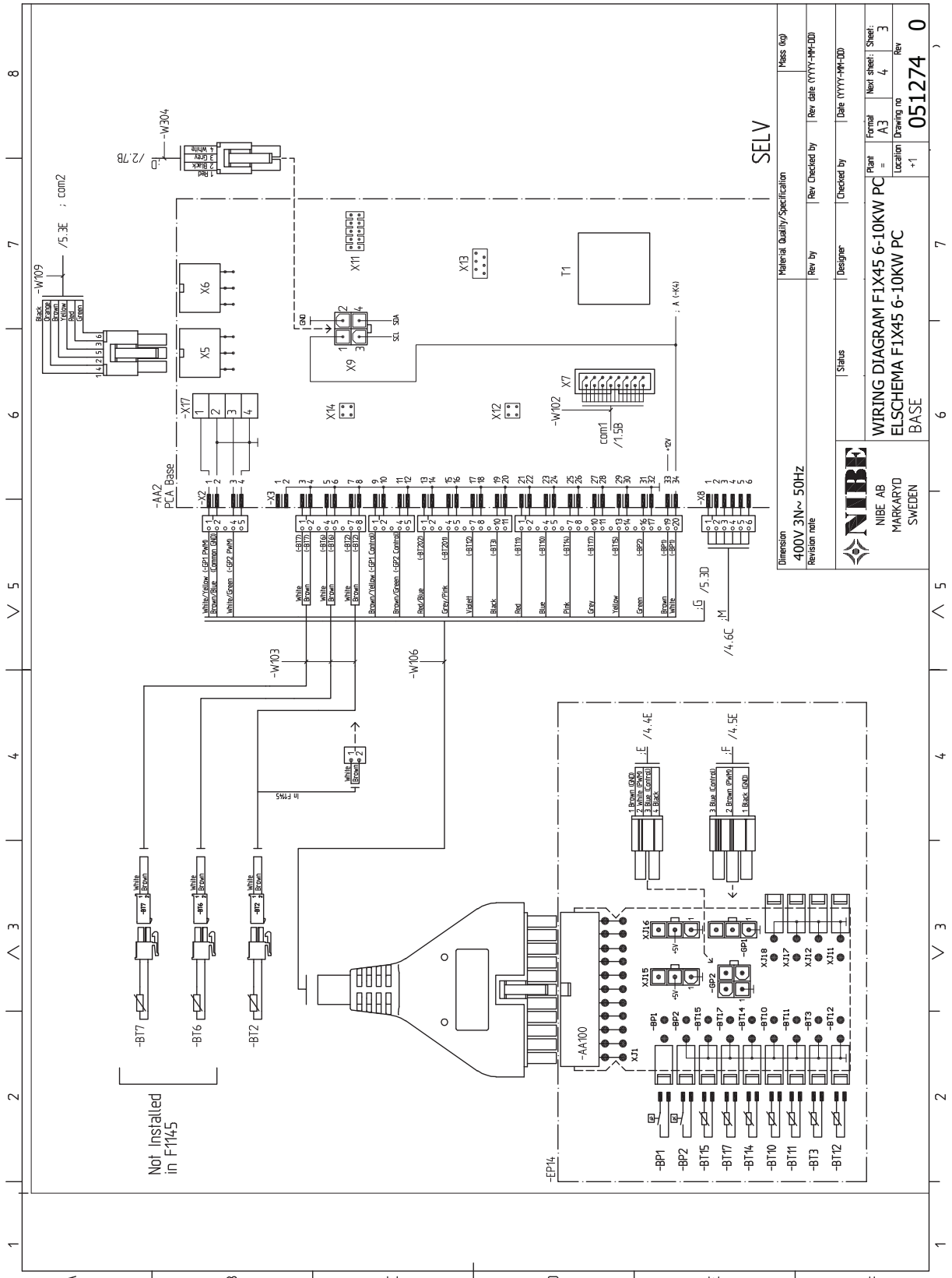

Dimension	Material Quality/Specification	Mass (kg)
400V 3N~ 50Hz		
Revision no	Rev. by	Rev. Checked by
	Designer	Checked by
	Status	Date (YYYY-MM-DD)
 NIBE AB MARKARYD SWEDEN	Plant	Formal
	WIRING DIAGRAM FIX45 6-10KW PC	A3
	ELSCHEMA FIX45 6-10KW PC	3
BASE	Location	Rev
	+1	051274
	0	

3X400V 6-10 KW

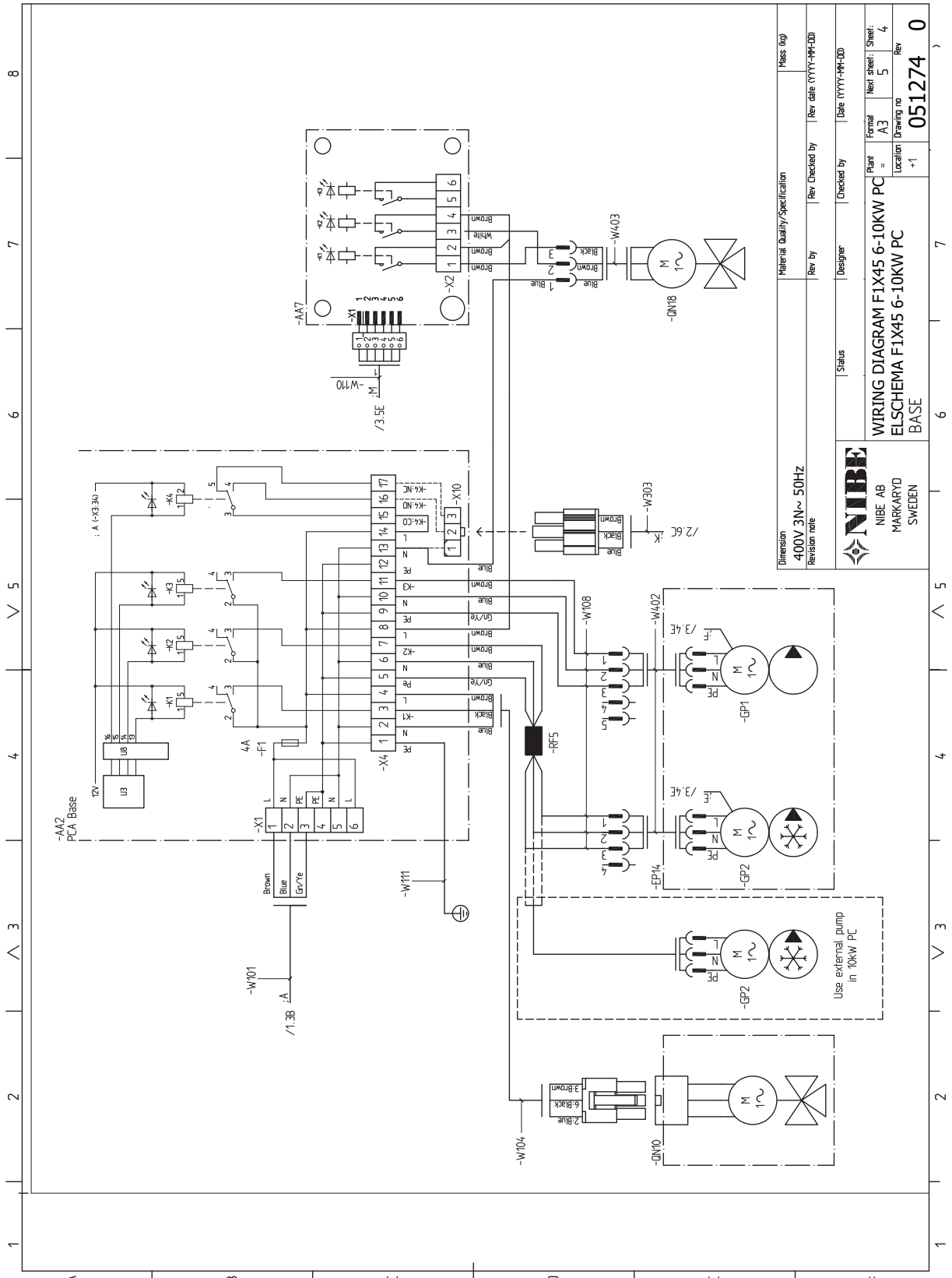

Dimension	Material Quality/Specification	Mass (kg)
400V 3N~ 50Hz		
Revision note	Rev. by	Rev. Checked by
	Designer	Checked by
	Status	Date (YYYY-MM-DD)
NIBE NIBE AB MARKARYD SWEDEN		
WIRING DIAGRAM FIX45 6-10KW PC ELSHEMA FIX45 6-10KW PC BASE		
Plant	Formal	Sheet
=	A3	5
Location	Drawing no	Rev
+1	051274	0

3X400V 6-10 KW

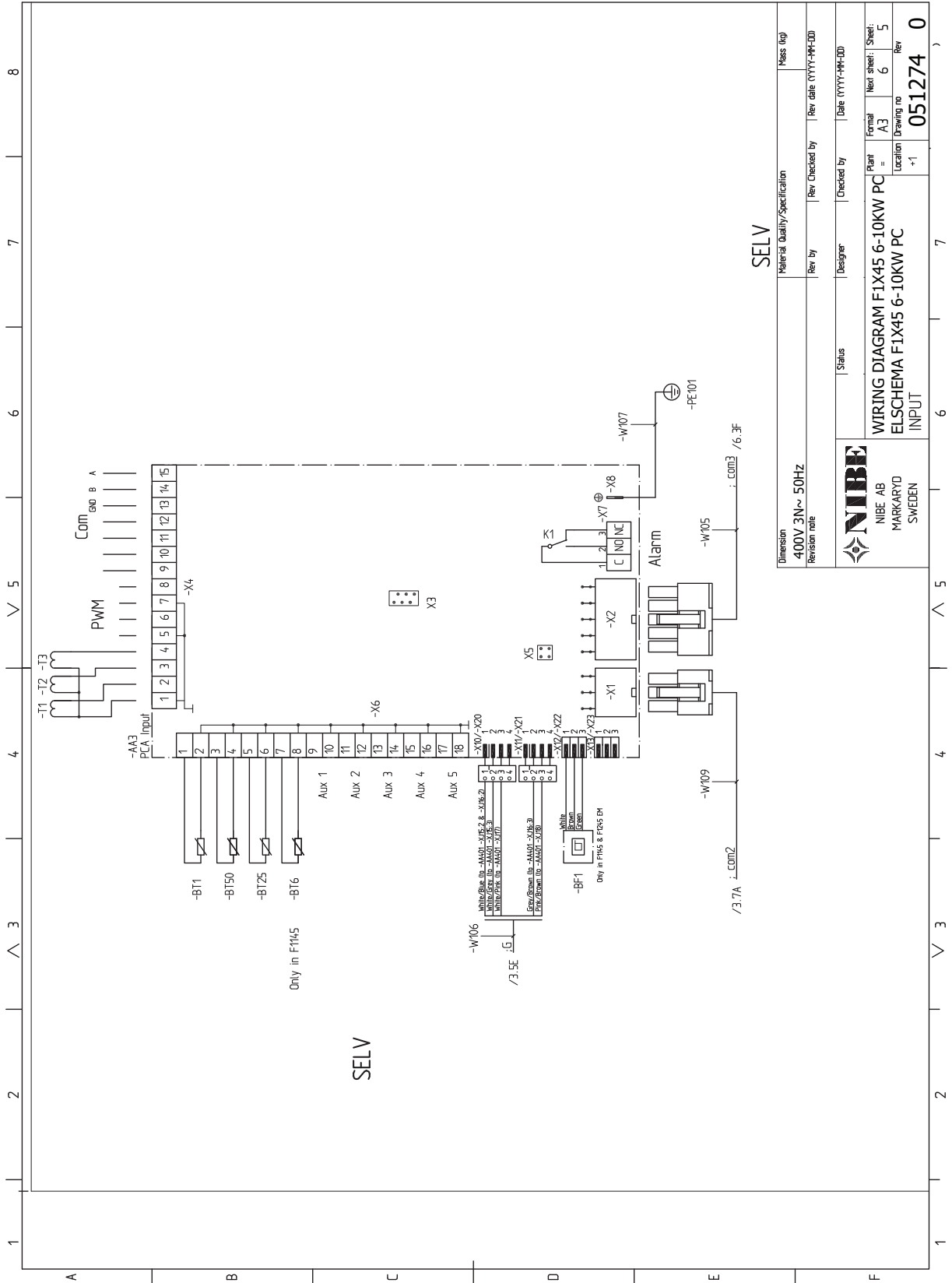

SELV

Dimension	Material Quality/Specification	Mass (kg)
400V 3N~ 50Hz		
Revision table	Rev. by	Rev. Checked by
	Designer	Checked by
	Status	Date (YYYY-MM-DD)
 NIBE AB MARKARYD SWEDEN	Plant	Formal Sheet
	WIRING DIAGRAM FIX45 6-10KW PC	A3
	ELSCHEMA FIX45 6-10KW PC	5
Location	Drawing no	Rev
+1	051274	0

3X400V 6-10 KW

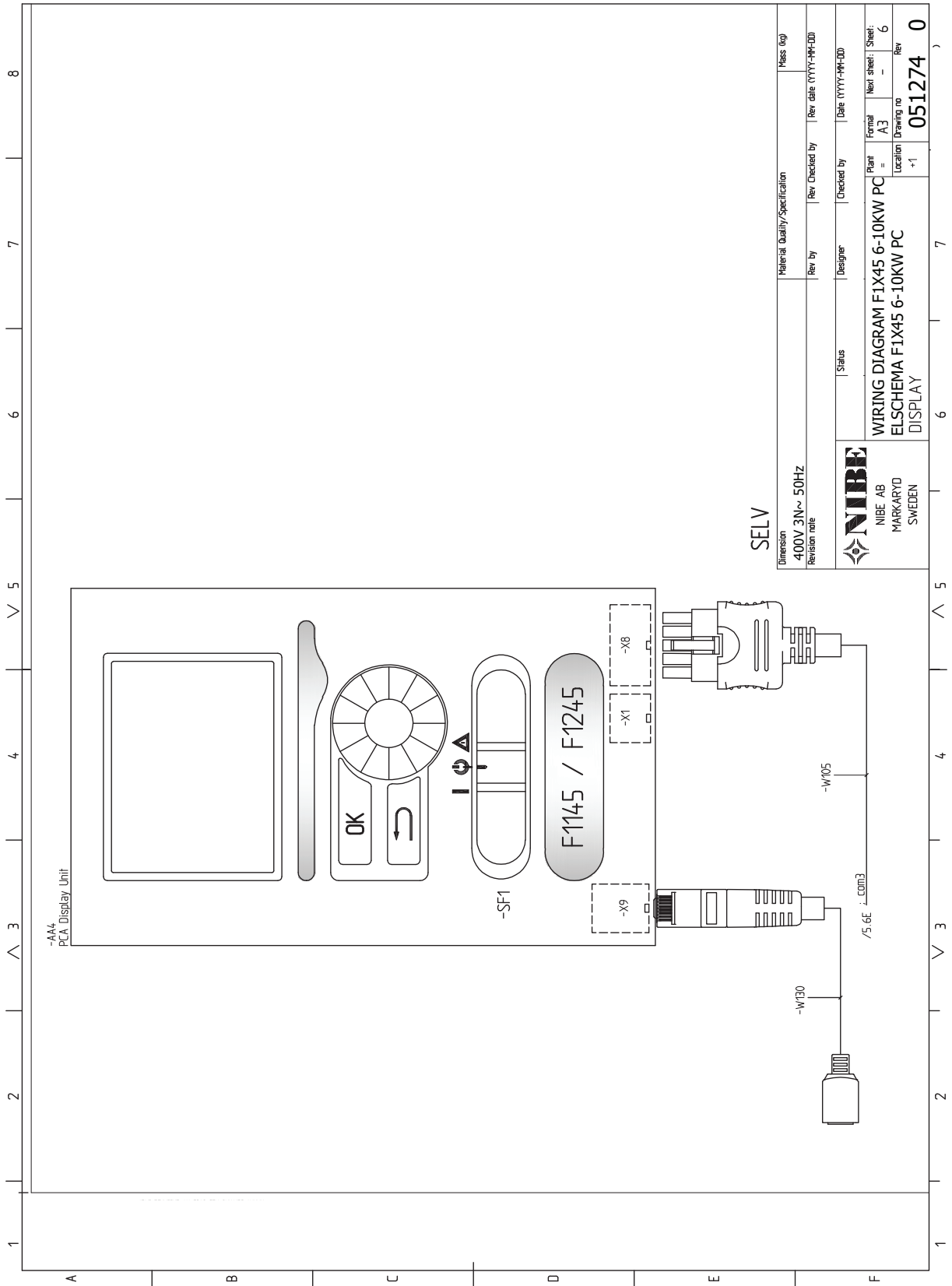

SELV

Dimension	Material Quality/Specification	Mass (kg)			
400V 3N~ 50Hz	Rev. by	Rev. date (YYYY-MM-DD)			
Revision note	Designer	Checked by			
 NIBE AB MARRKARYD SWEDEN	Status	Date (YYYY-MM-DD)			
	WIRING DIAGRAM FIX45 6-10KW PC	Plant	Formal	Next sheet	Sheet
	ELSHEMA FIX45 6-10KW PC	Location	Drawing no	Rev	Rev
DISPLAY	+1	051274	0		

NIBE Energy Systems
Hannabadsvägen 5
Box 14
SE-285 21 Markaryd
info@nibe.se
nibe.eu

WHB EN 2451-1 831482

This is a publication from NIBE Energy Systems. All product illustrations, facts and data are based on the available information at the time of the publication's approval.

NIBE Energy Systems makes reservations for any factual or printing errors in this publication.

©2025 NIBE ENERGY SYSTEMS

