

Wiring diagram

NIBE

NIBE F1145/F1245

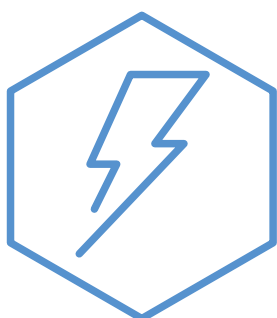

WHB EN 2451-1
831481

Table of Contents

1x230V 5-12 kW (F1145/F1245) _____	4
3x230V 15-17 kW (F1145) _____	10
3x230V 6-10 kW (F1145/F1245) _____	15
3x400V 6-10 kW (F1145/F1245) _____	20
3x400V 12 kW (F1145/F1245) _____	26
3x400V 15-17 kW (F1145) _____	32

1X230V 5-12 KW (F1145/F1245)

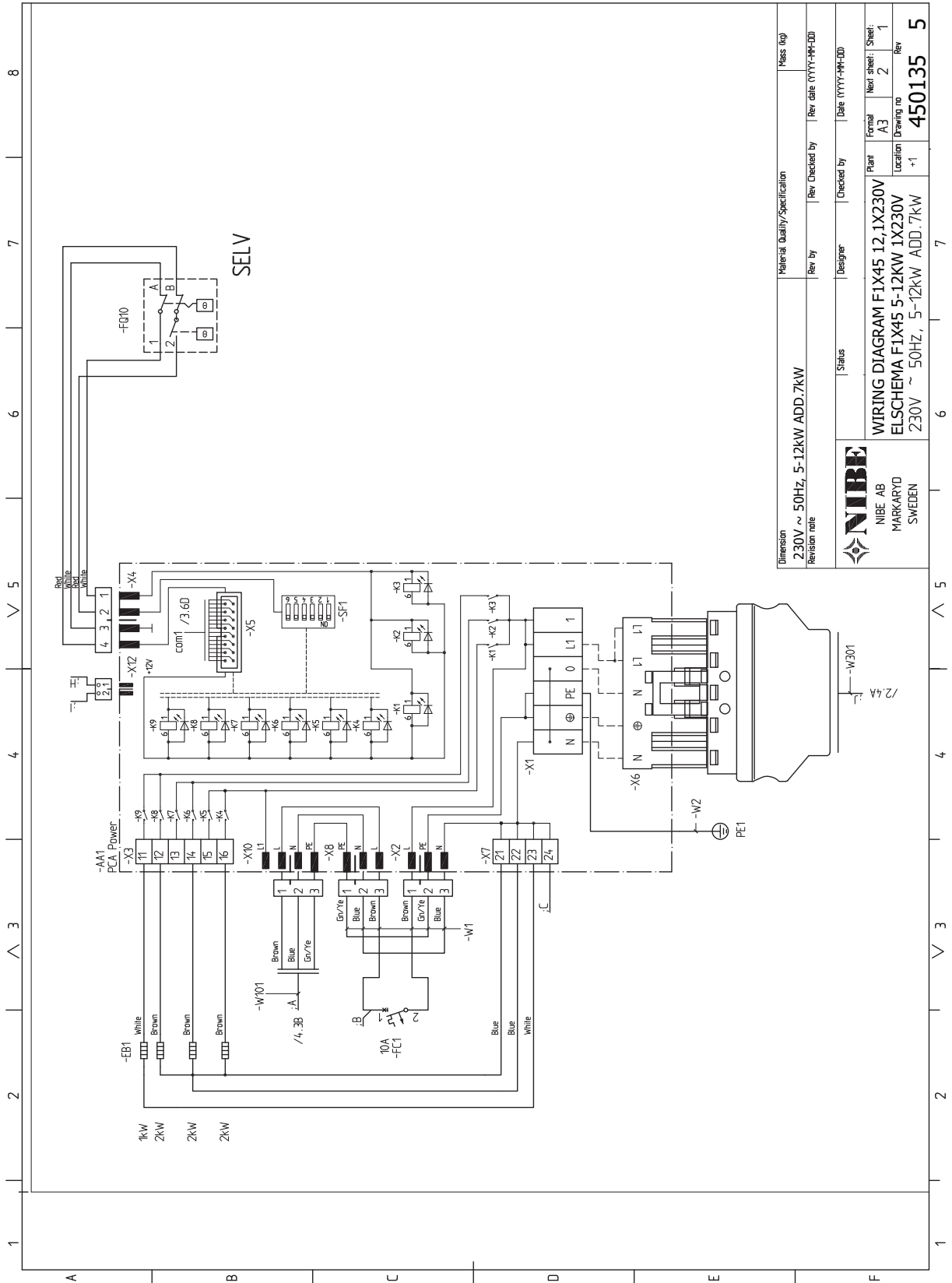

Dimension	Material Quality/Specification	Mass (kg)	
Revision note	Rev. by	Rev. Date (YYYY-MM-DD)	
 NIBE AB MARKARYD SWEDEN	Status	Checked by	
	Designer	Date (YYYY-MM-DD)	
	Plant	Formal	Next sheet / Sheet
	Location	Drawing no	Rev
230V ~ 50HZ, 5-12kW ADD. 7kW	WIRING DIAGRAM FLX45 12, 1X230V		
	ELSCHEMA F1X45 5-12KW 1X230V		
	230V ~ 50HZ, 5-12kW ADD. 7kW		
		450135	
		5	

1X230V 5-12 KW (F1145/F1245)

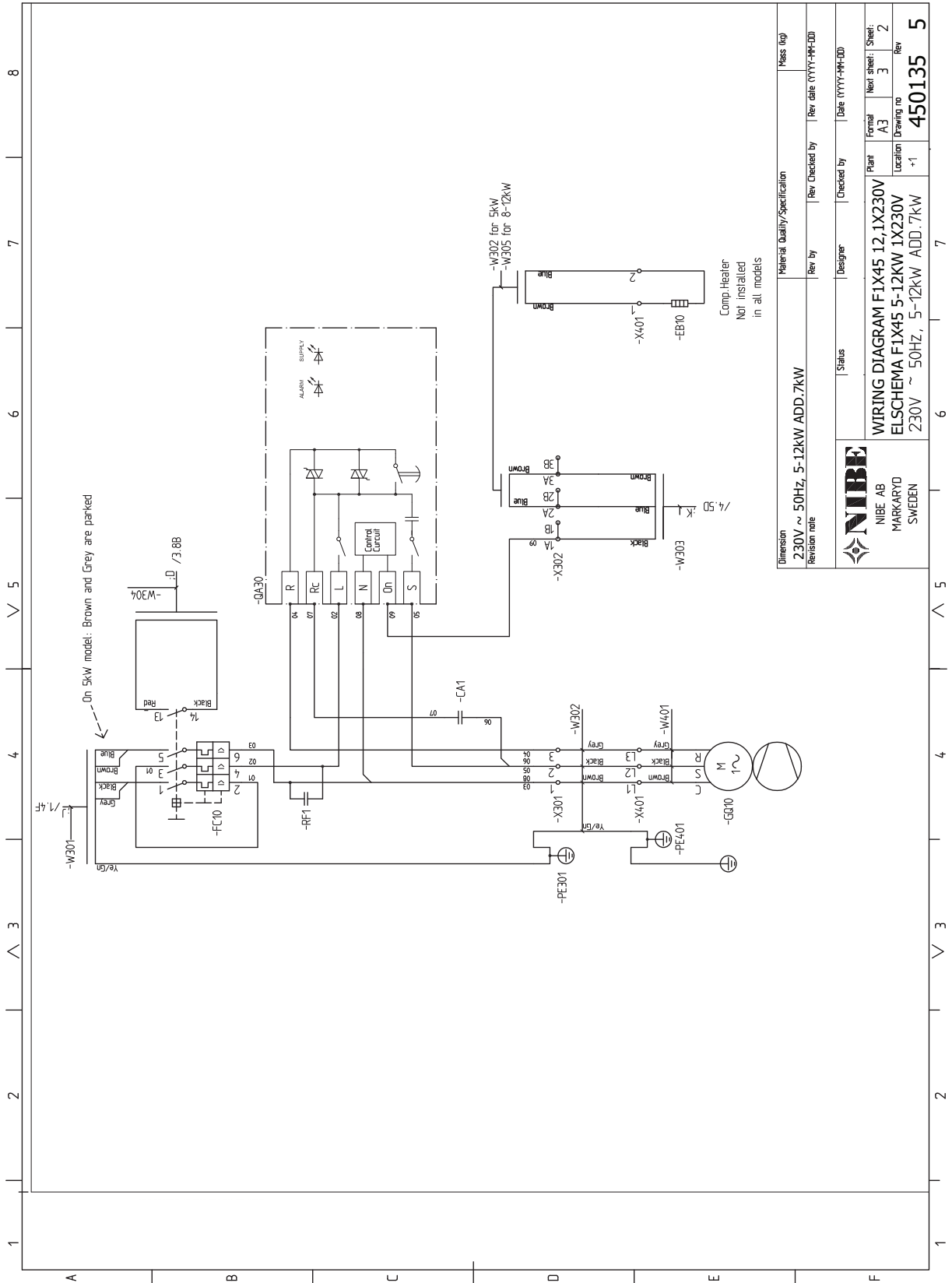

Dimension	Material Quality/Specification		Mass (kg)
Revision	230V ~ 50HZ, 5-12kW ADD.7kW	Rev. by	Rev. Date (YYYY-MM-DD)
Revision note		Designer	Checked by
		Status	Date (YYYY-MM-DD)
		Plant	Formal
		WIRING DIAGRAM FLX45 12.1X230V	A3
		ELSCHEMA F1X45 5-12KW 1X230V	3
		230V ~ 50HZ, 5-12kW ADD.7kW	2
		Location	Drawing no
		+1	450135
		Rev	5



1X230V 5-12 KW (F1145/F1245)

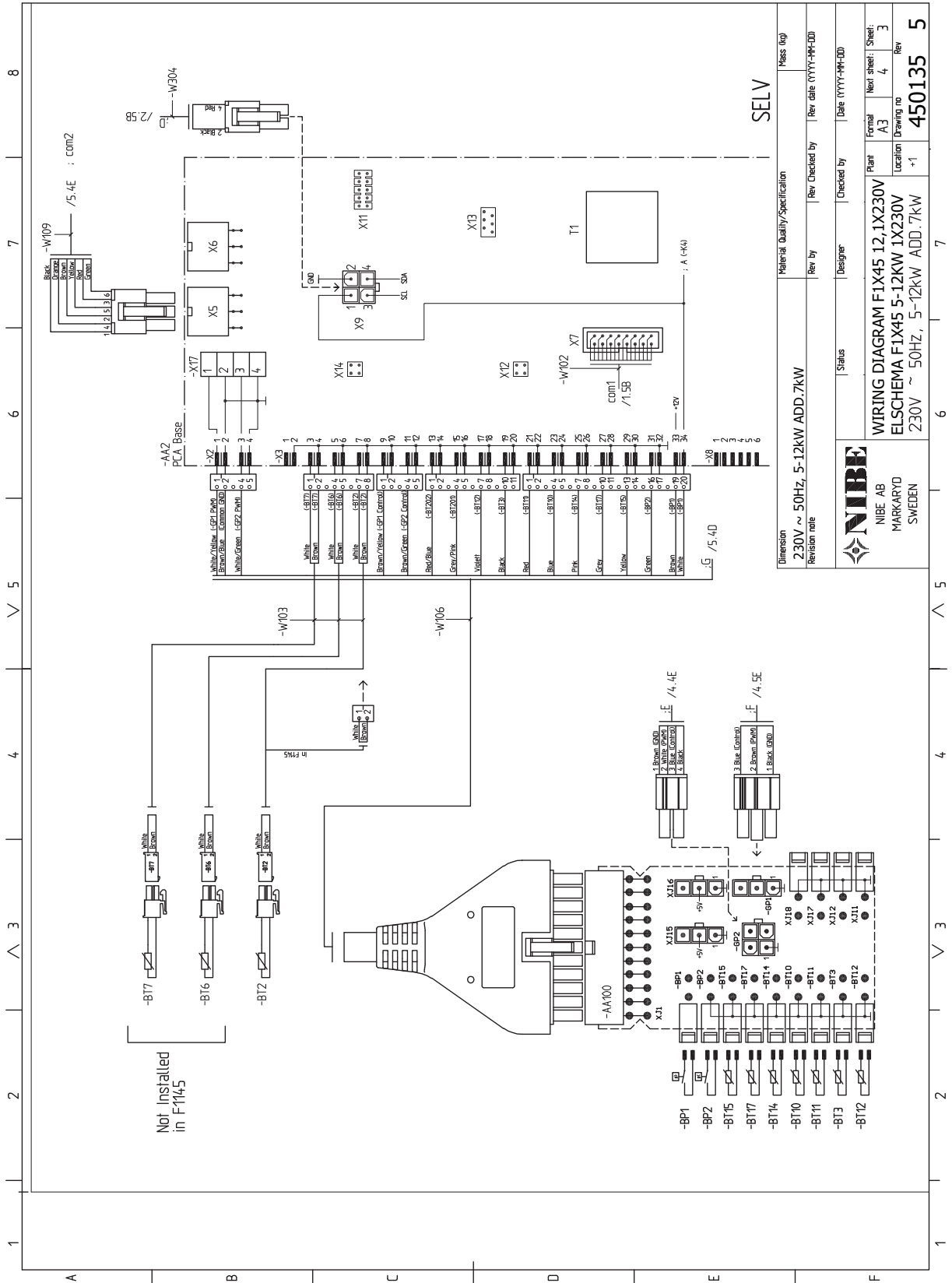

Dimension	Material Quality/Specification	Mass (kg)
Revision note	230V ~ 50HZ, 5-12KW ADD.7KW	
Revision	Rev by	Rev Checked by
Revision	Designer	Checked by
Revision	Status	Date (YYYY-MM-DD)
Revision	Plant	Formal
Revision	Location	Next sheet / Sheet
Revision	Drawing no	Rev
Revision	450135	5

NIBE
 NIBE AB
 MARKARYD
 SWEDEN

SELV

Not installed
 in F1145

1X230V 5-12 KW (F1145/F1245)

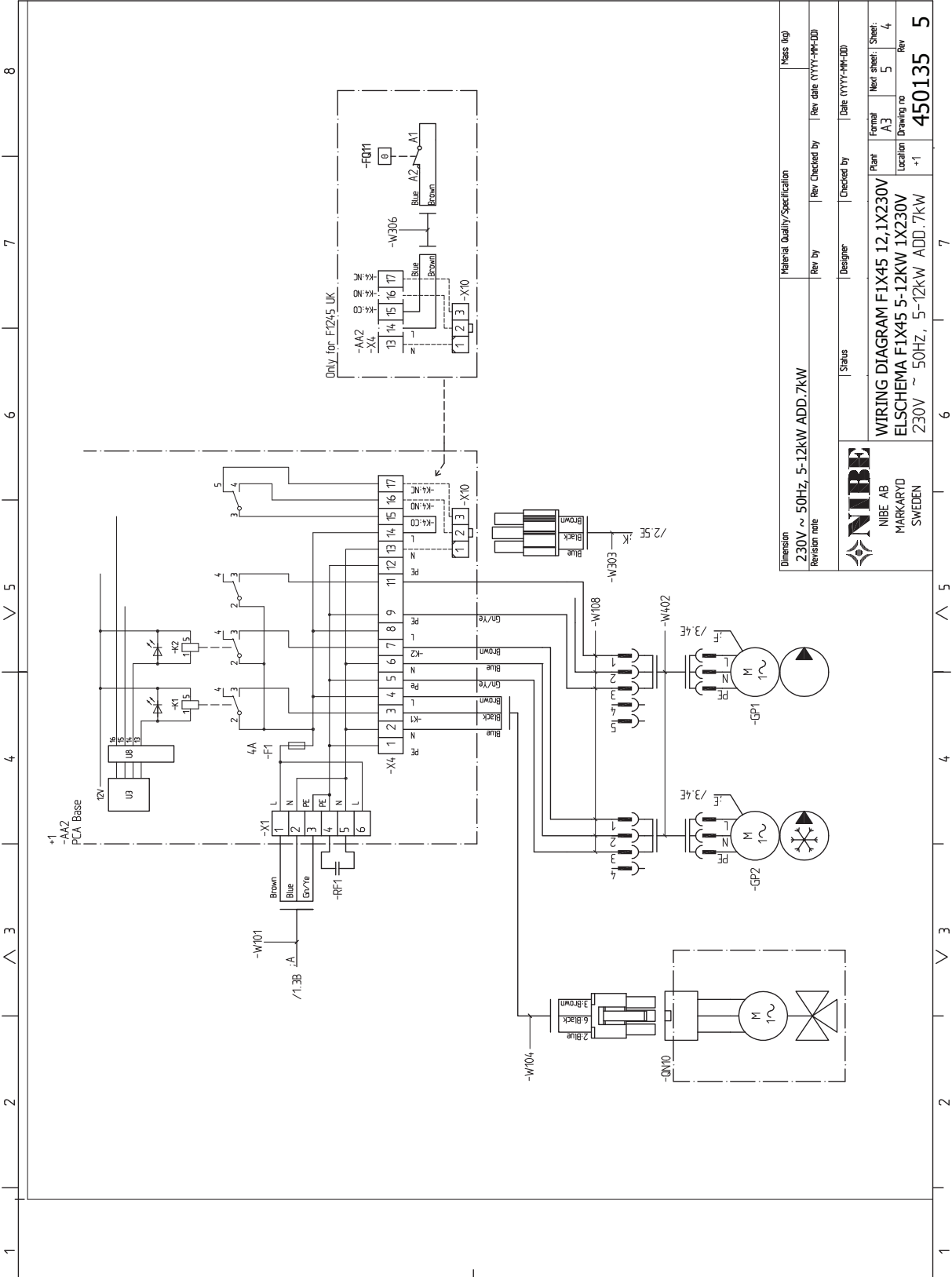

Dimension	Material Quality/Specification	Mass (kg)
Revision note	Rev by	Rev Date (YYYY-MM-DD)
NIBE NIBE AB MARKARYD SWEDEN		
WIRING DIAGRAM FLX45 12, 1X230V ELSCHEMA F1X45 5-12KW 1X230V 230V ~ 50HZ, 5-12kW ADD.7kW		
Status	Designer	Checked by
Date (YYYY-MM-DD)	Plant	Formal
	Location	Next sheet / Sheet
		5 / 4
	Drawing no	Rev
	450135	5

1X230V 5-12 KW (F1145/F1245)

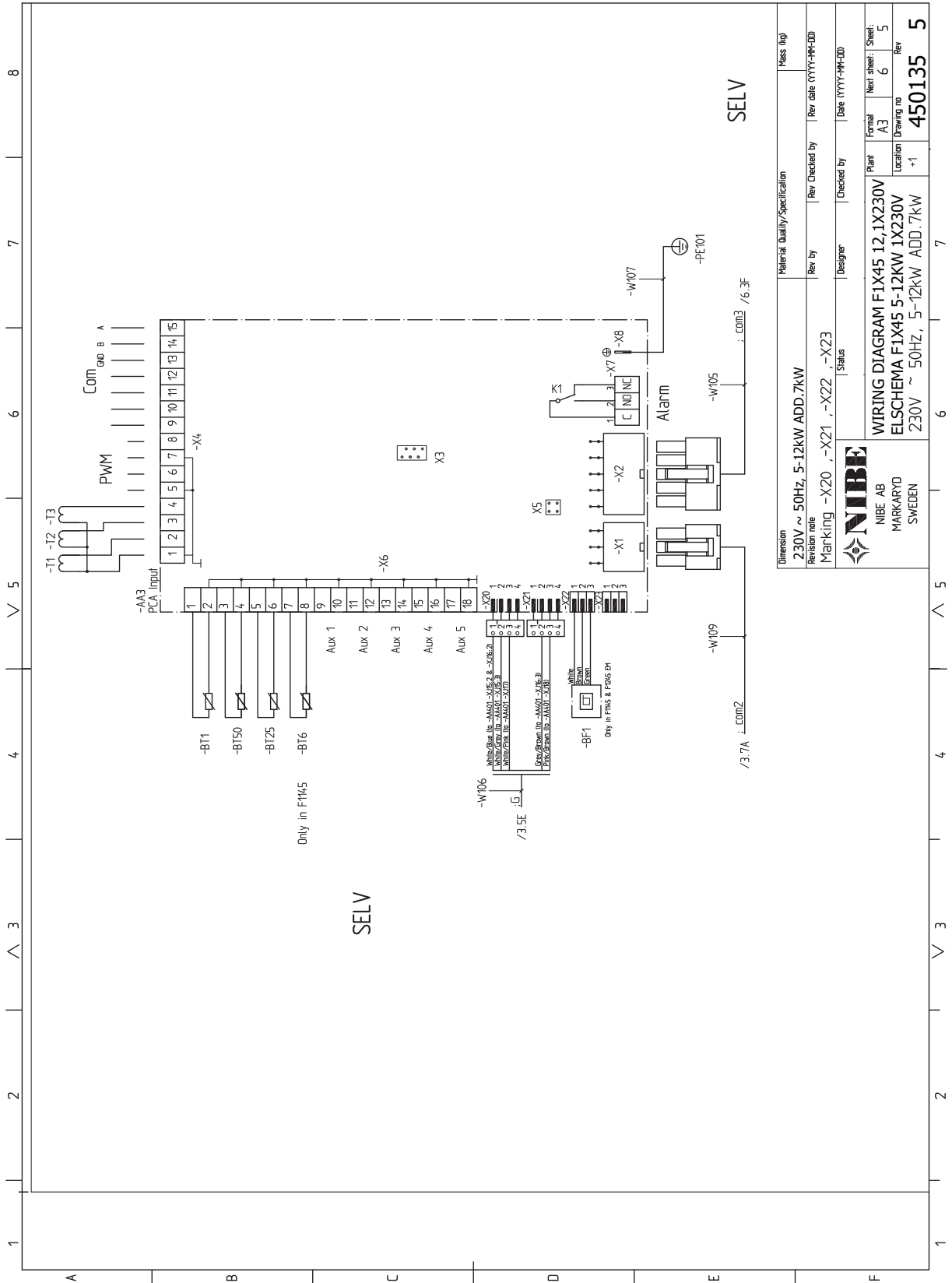

Material Quality/Specification		Mess (kg)	
Dimension	230V ~ 50HZ, 5-12KW ADD.7KW	Rev by	Rev Checked by
Revision note	Marking -X20, -X21, -X22, -X23	Designer	Date (YYYY-MM-DD)
		Status	Checked by
NIBE AB MARKARYD SWEDEN		Plant	Formal
WIRING DIAGRAM FLX45 12, 1X230V ELSHEMA F1X45 5-12KW 1X230V 230V ~ 50HZ, 5-12KW ADD.7KW		Location	Next sheet / Sheet
		+1	6 / 5
		450135	Rev
		5	

1X230V 5-12 KW (F1145/F1245)

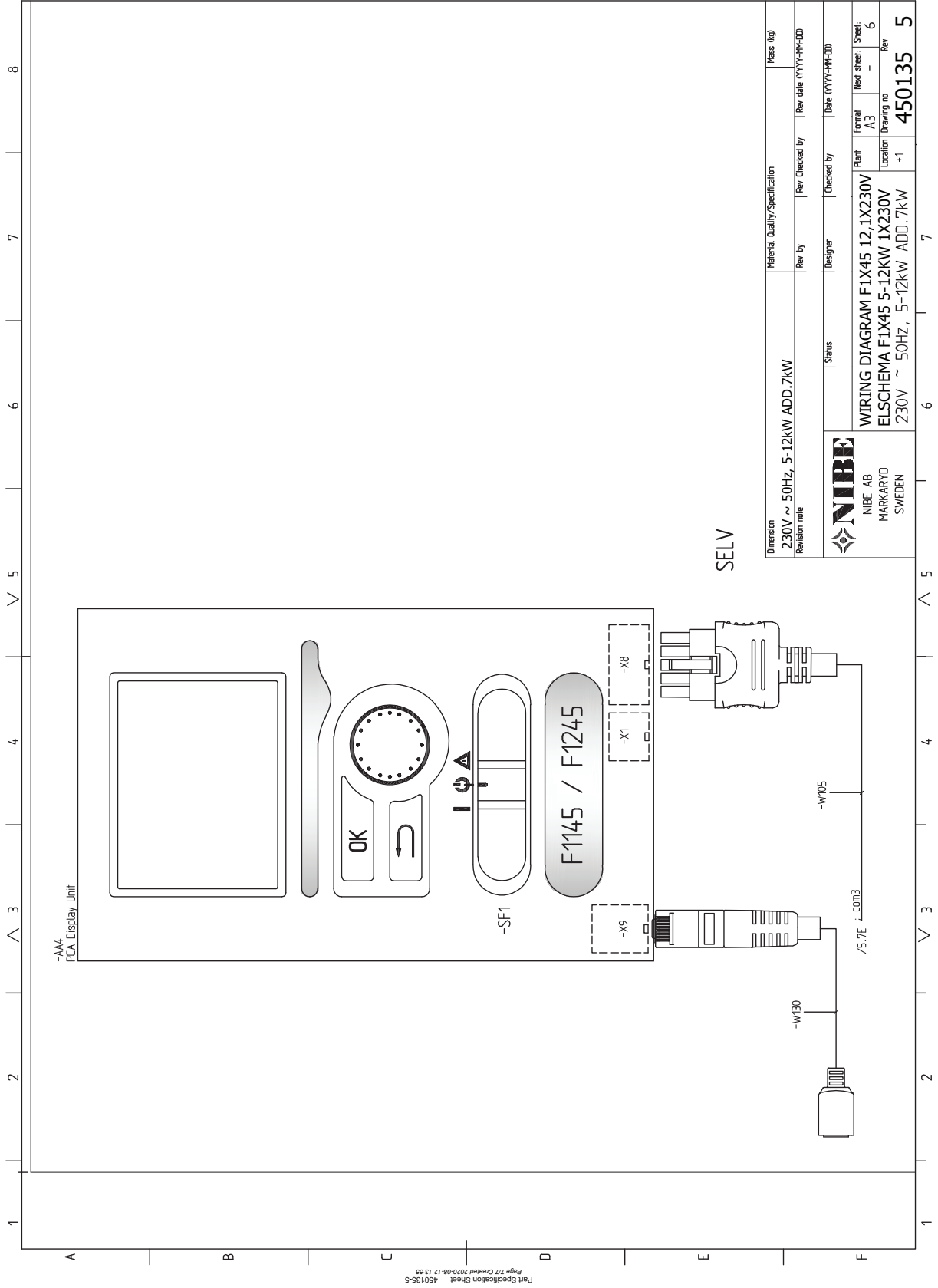

Part Specification Sheet 450135-5
Page 7/7 Created: 2020-08-12 13:55

Dimension	Material Quality/Specification	Mass (kg)
230V ~ 50Hz, 5-12kW ADD.7kW		
Revision note	Rev. by	Rev. Checked by
		Rev. Date (YYYY-MM-DD)
NIBE NIBE AB MARKARYD SWEDEN	Status	Designer
	Checked by	Date (YYYY-MM-DD)
WIRING DIAGRAM FLX45 12, 1X230V	Plant	Formal
ELSHEMA F1X45 5-12KW 1X230V	A3	Next sheet / Sheet
230V ~ 50Hz, 5-12kW ADD.7kW	Location	Drawing no
	+1	450135
		Rev
		5

3X230V 15-17 KW (F1145)

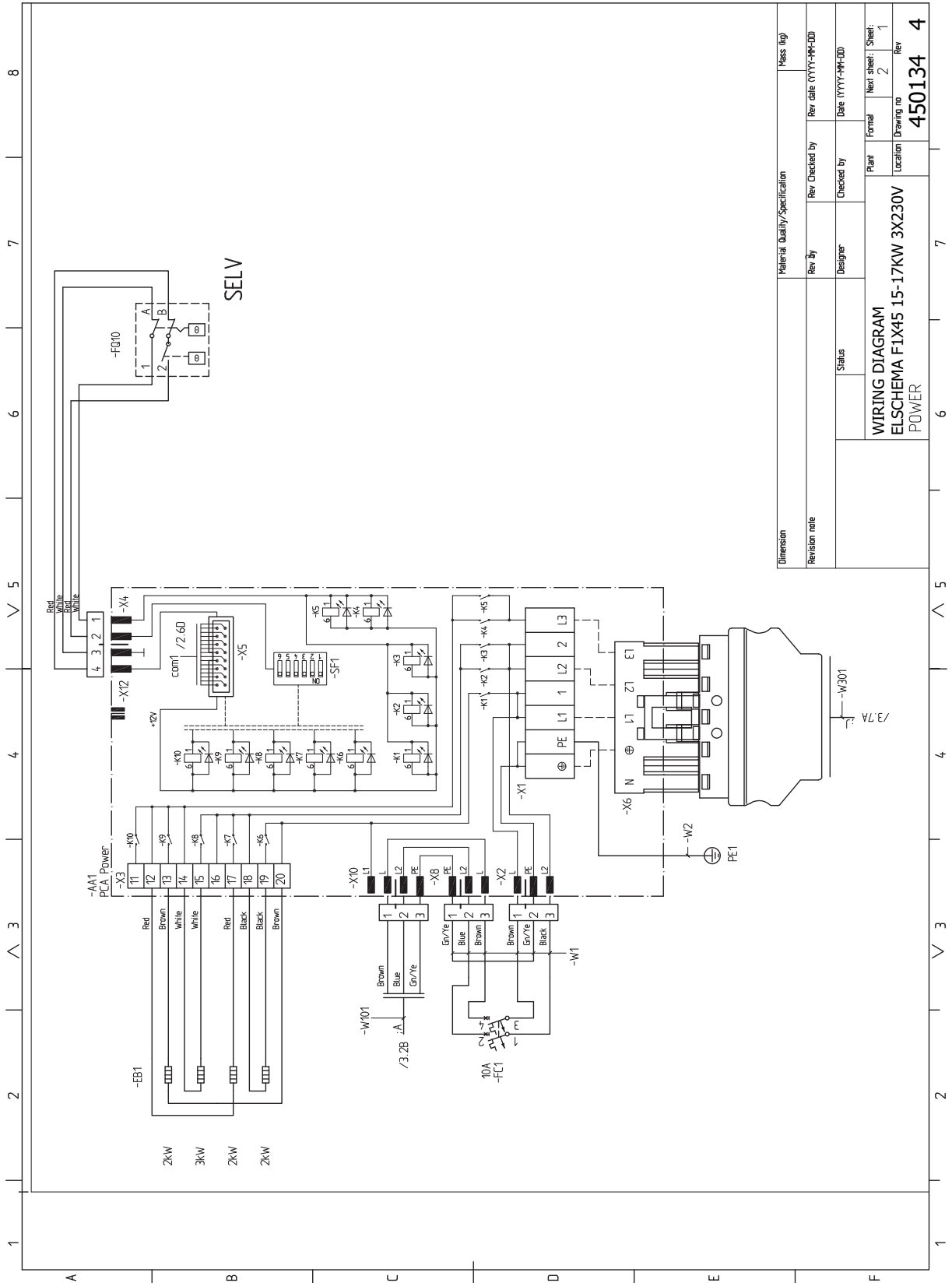

Dimension	Material Quality/Specification	Mass (kg)
Revision note	Rev. By	Rev. Checked by
	Designer	Checked by
	Status	Date (YYYY-MM-DD)
	Plant	Rev. sheet: Sheet: 1
	Location	2
	Drawing no	450134
	Rev	4

WIRING DIAGRAM
 ELSCHEMA FIX45 15-17KW 3X230V
 POWER

3X230V 15-17 KW (F1145)

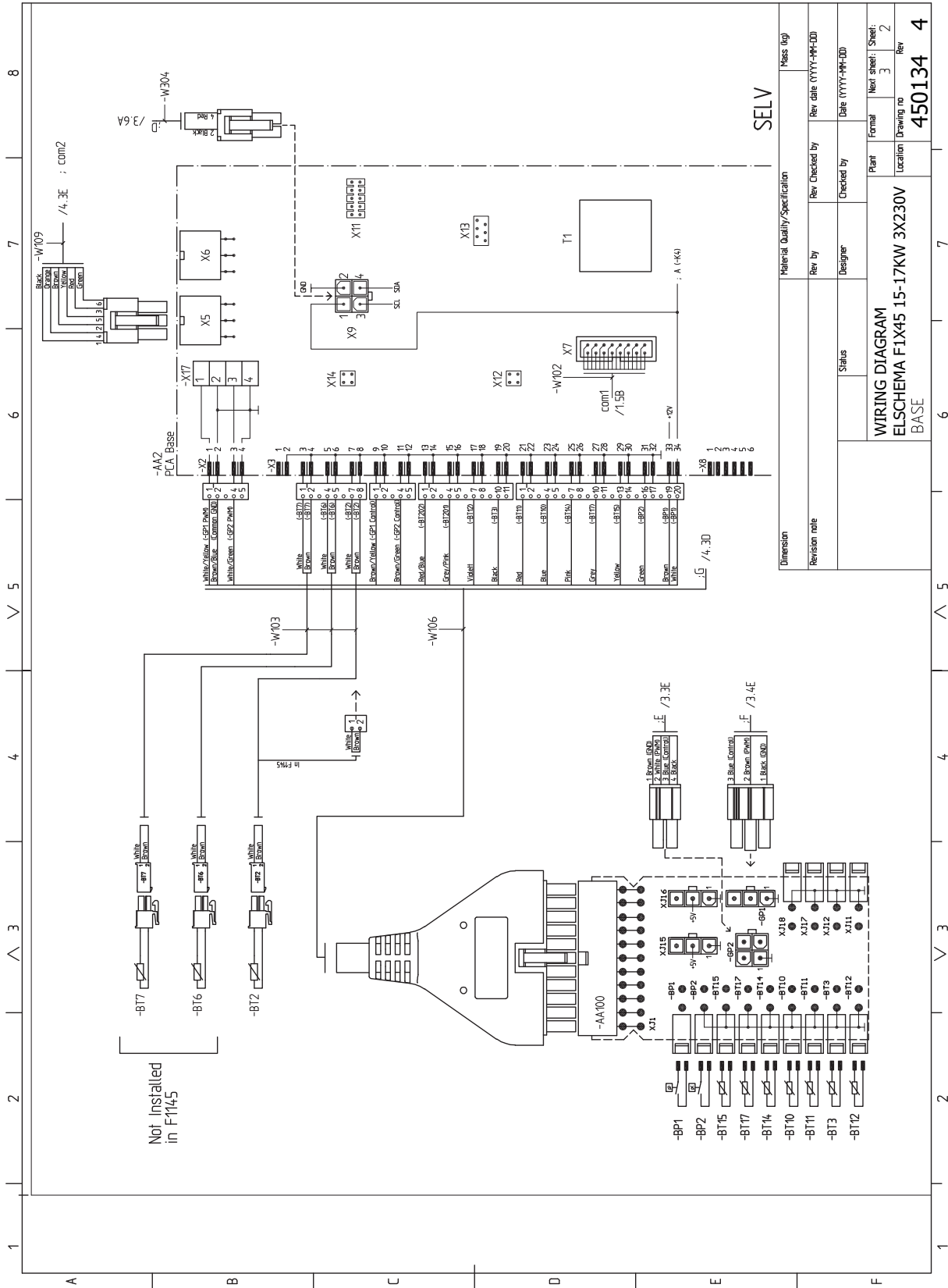

Material Quality/Specification		Mass (kg)	
Rev by	Rev Checked by	Rev date (YYYY-MM-DD)	
Designer	Checked by	Date (YYYY-MM-DD)	
Status	Plant	Format	Next sheet: Sheet 2
WIRING DIAGRAM		Location	Drawing no
ELSCHEMA FIX45 15-17KW 3X230V		450134	Rev 4
BASE			

3X230V 15-17 KW (F1145)

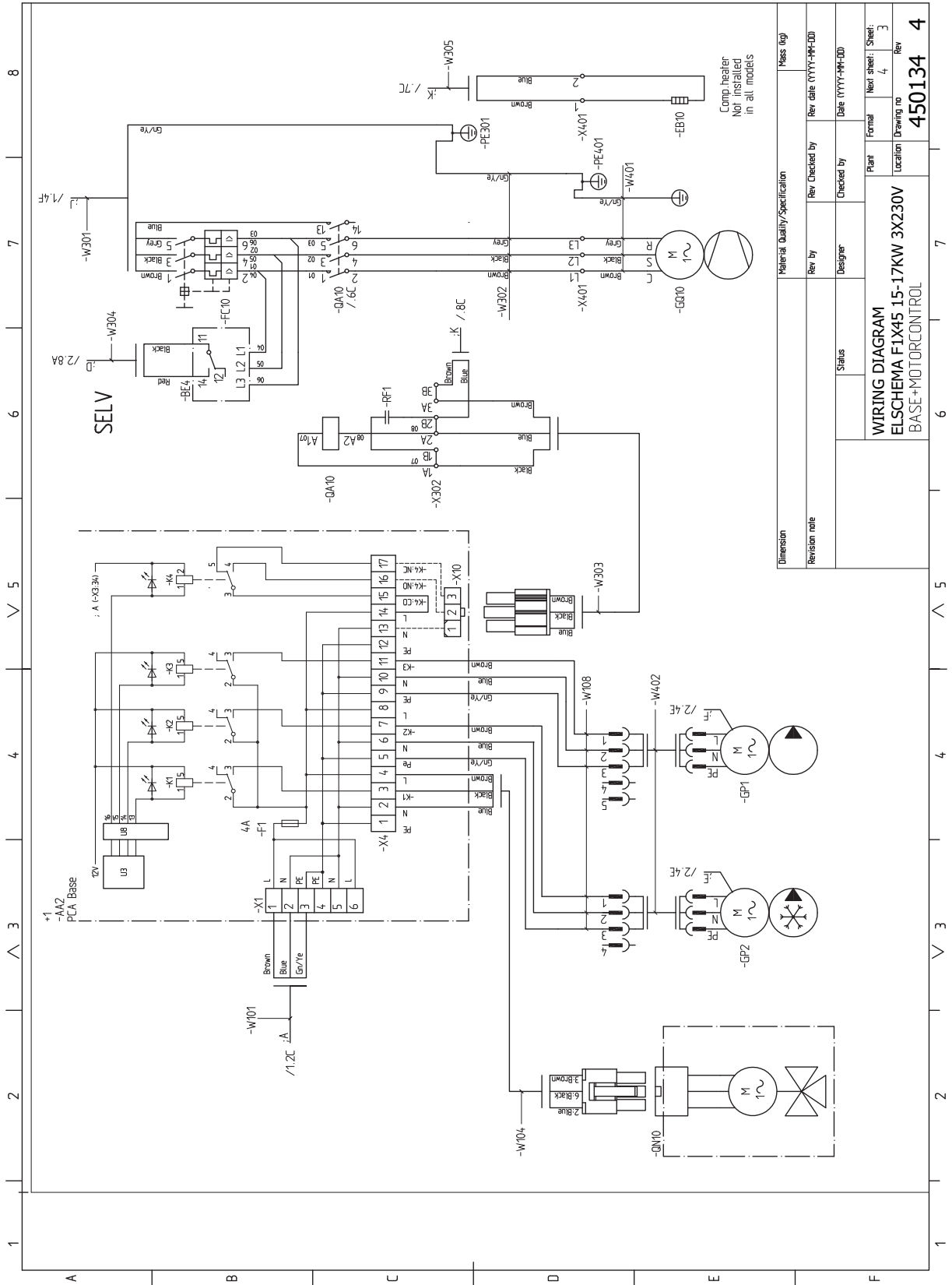

Dimension		Material Quality/Specification		Mass (kg)	
Revision note		Rev. by	Rev. Checked by	Rev. date (YYYY-MM-DD)	
		Designer	Checked by	Date (YYYY-MM-DD)	
		Status	Plant	Format	Next sheet: Sheet: 3
		WIRING DIAGRAM		Location	Drawing no
		ELSHEMA FIX45 15-17KW 3X230V		450134	4
		BASE+MOTORCONTROL			

3X230V 15-17 KW (F1145)

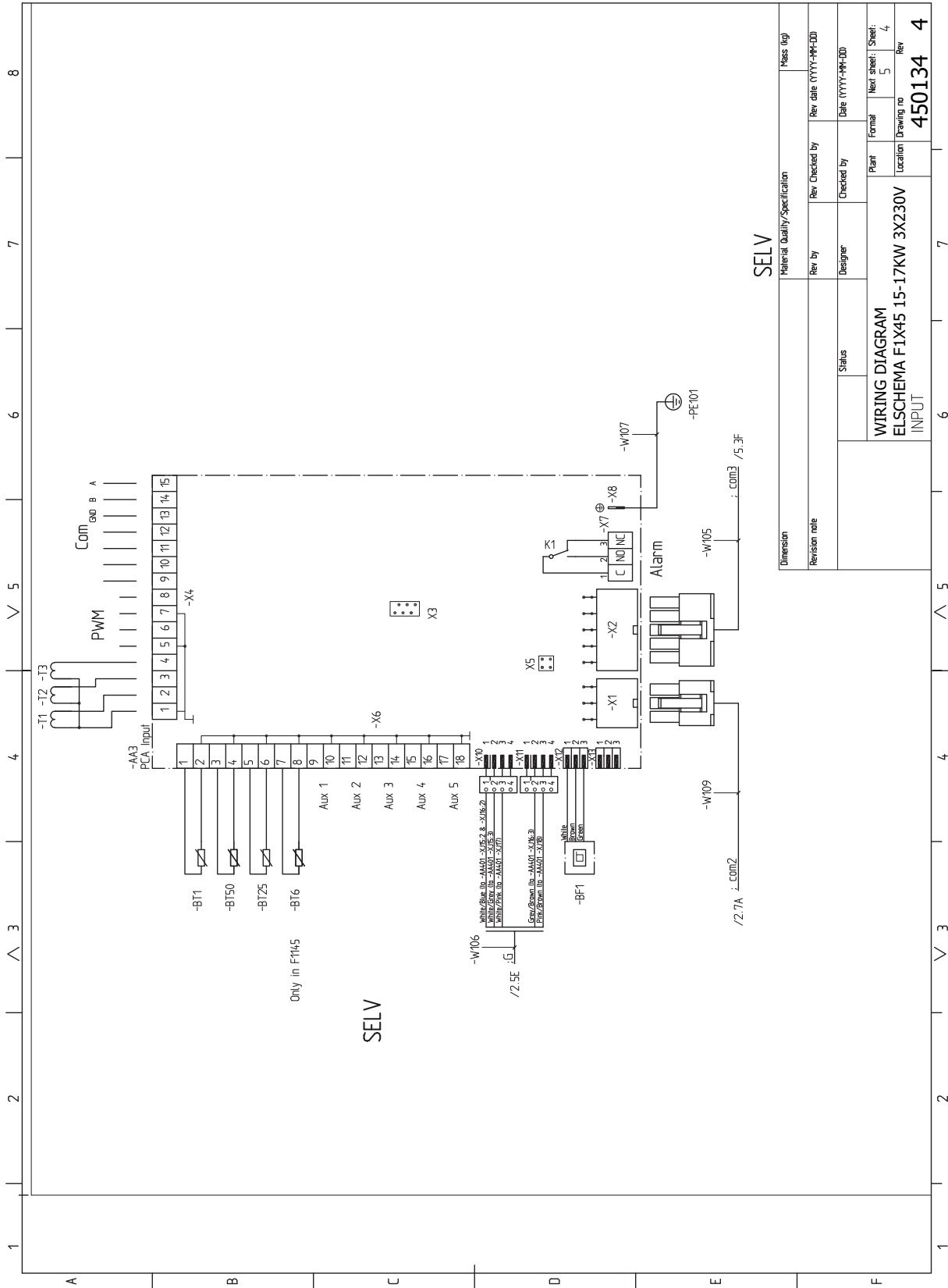

SELV

Material Quality/Specification		Mass (kg)	
Revision note	Rev. Checked by	Rev. date (YYYY-MM-DD)	
Status	Designer	Checked by	Date (YYYY-MM-DD)
WIRING DIAGRAM		Plant	Format
ELSCHEMA FIX45 15-17KW 3X230V		Location	Next sheet: Sheet: 4
INPUT		Drawing no	Rev
		450134	4

3X230V 15-17 KW (F1145)

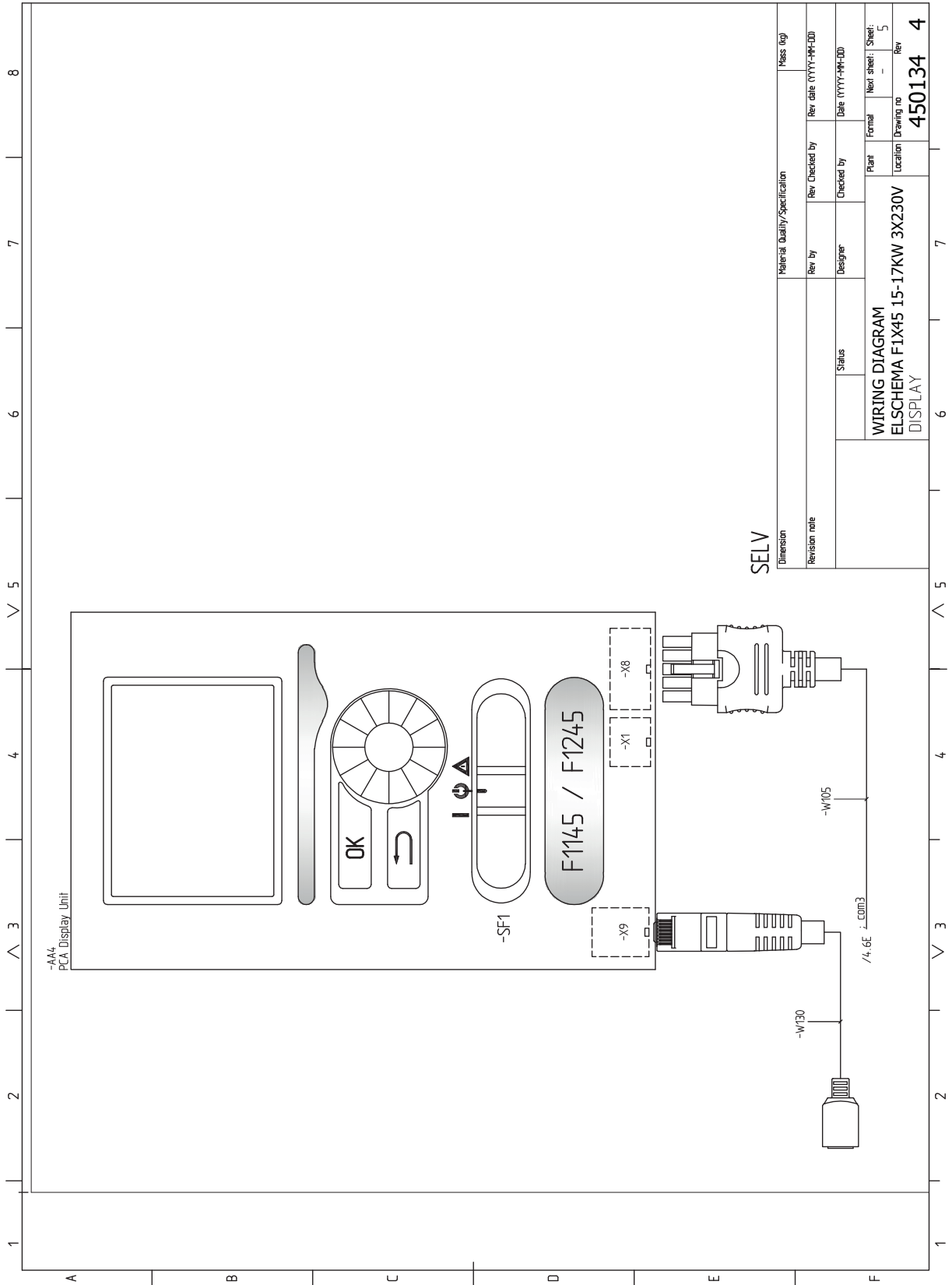

3X230V 6-10 KW (F1145/F1245)

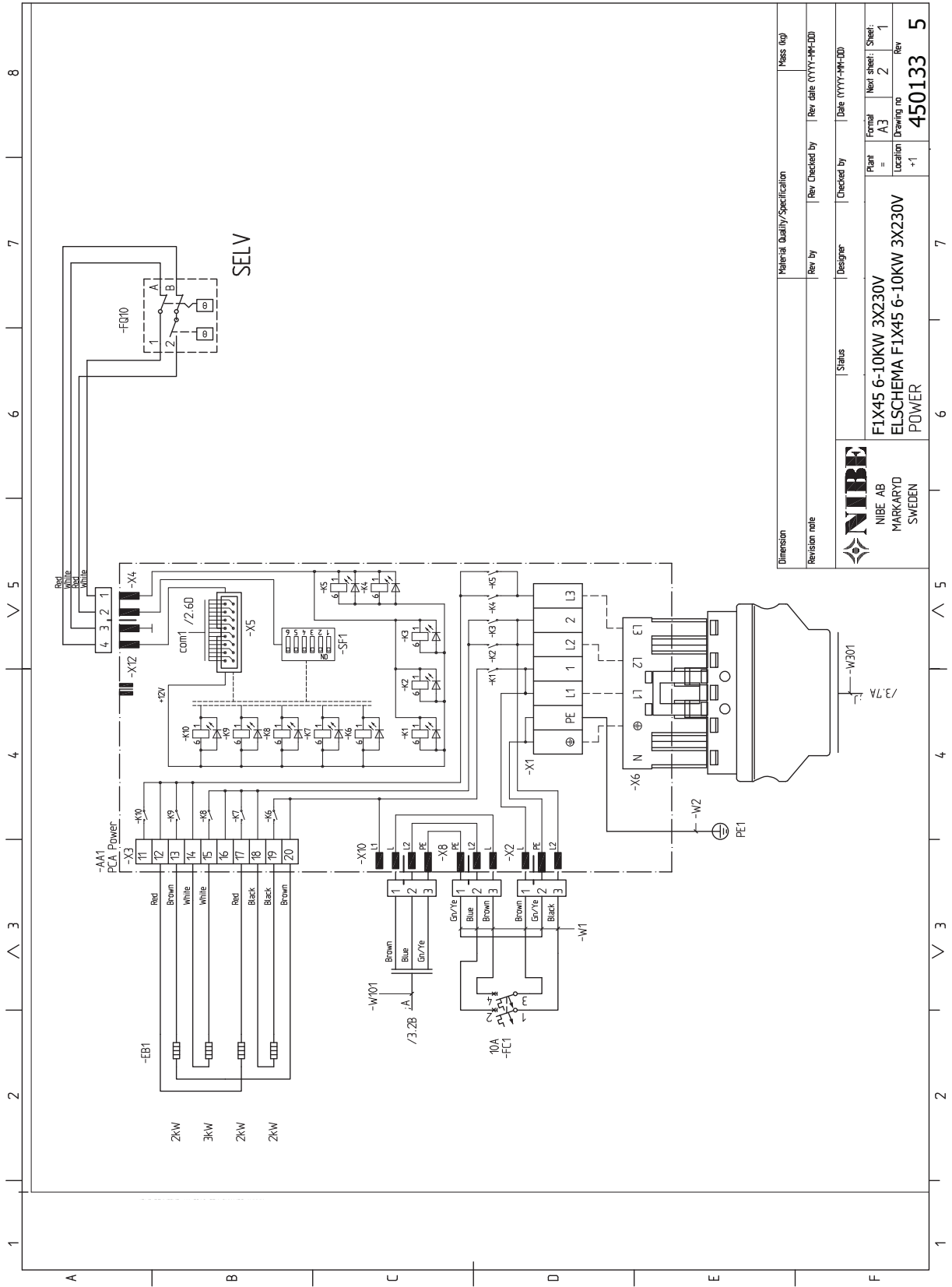

3X230V 6-10 KW (F1145/F1245)

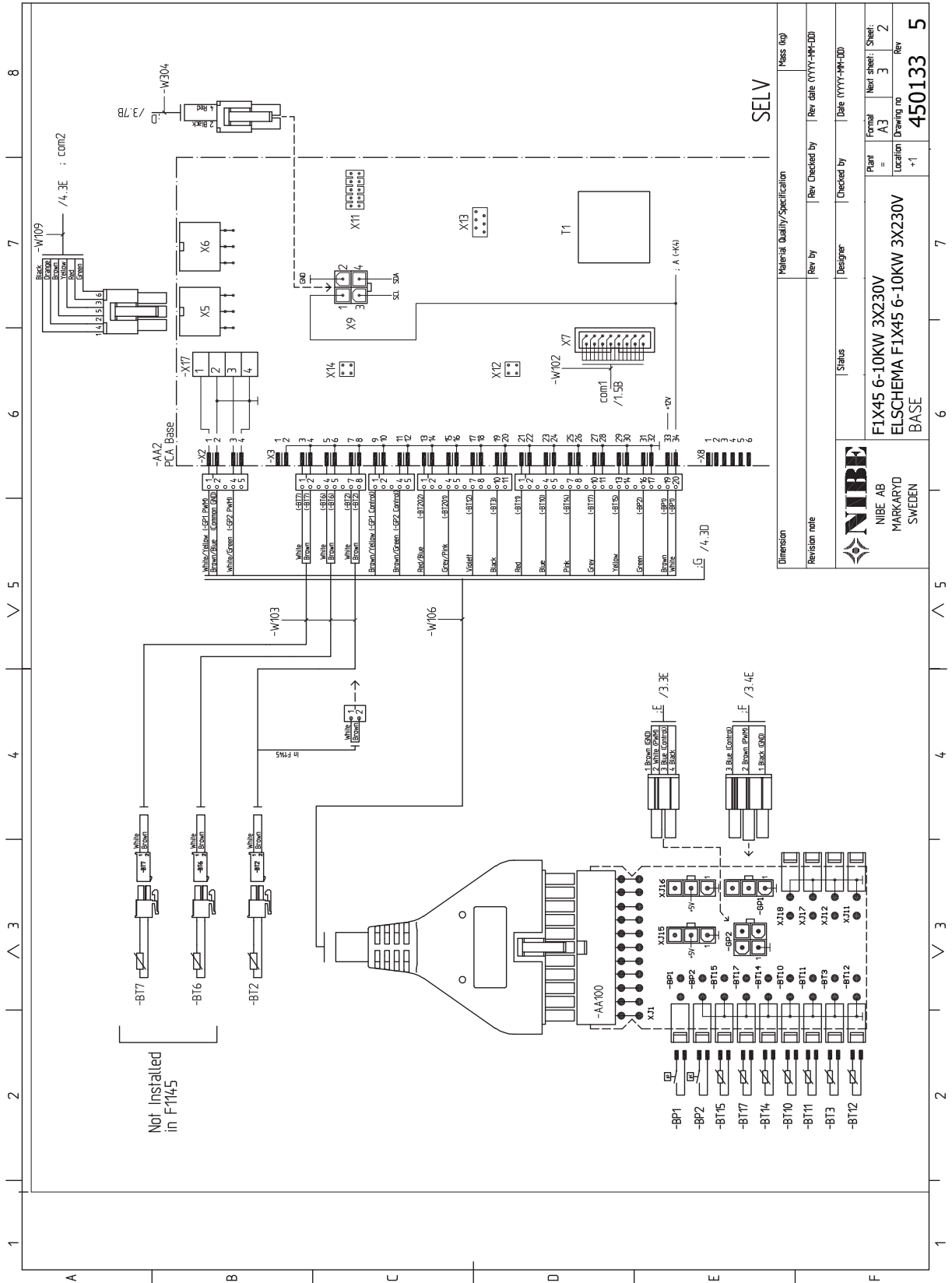

SELV

Material Quality/Specification	Mess (kg)	
Revision note	Rev by	Rev Checked by
	Designer	Checked by
	Status	Date (YYYY-MM-DD)
FIX45 6-10KW 3X230V ELSCHEMA F1X45 6-10KW 3X230V BASE	Plant =	Formal
MARKARYD	A3	Next sheet: 3
SWEDEN	Location	Sheet: 2
	+1	Rev
		450133
		5

3X230V 6-10 KW (F1145/F1245)

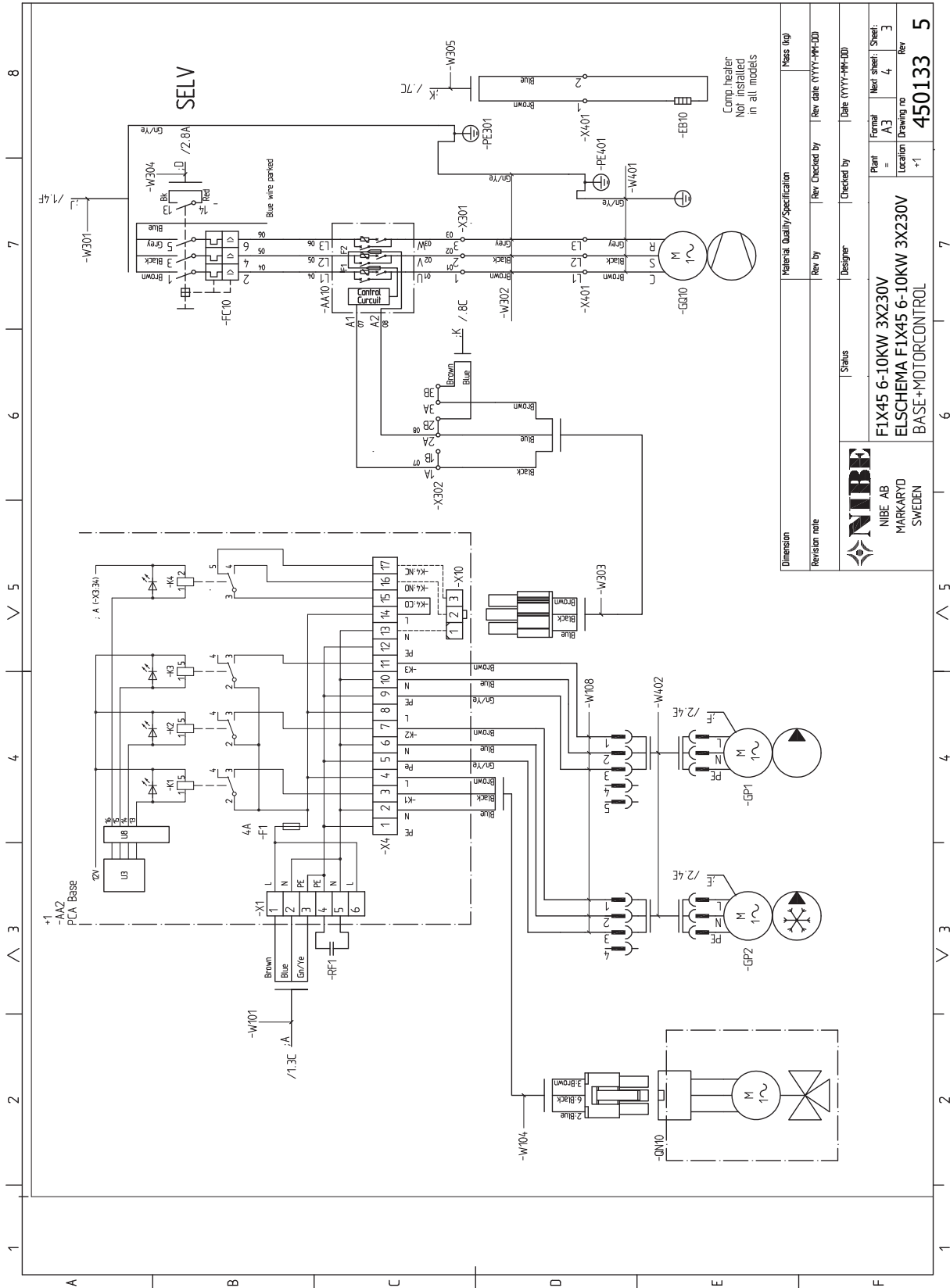

Material Quality/Specification	Material Quality/Specification	Checked by	Date (YYYY-MM-DD)
Revision note	Revision note	Rev Checked by	Rev Date (YYYY-MM-DD)
 NIBE NIBE AB MARKARYD SWEDEN	Status	Designer	Checked by
	Plant	Formal	Next sheet / Sheet
	Location	Location	Drawing no
	Rev	Rev	Rev
Dimension Material Quality/Specification Revision note		Mess (kg) Rev Checked by Date (YYYY-MM-DD)	
F1X45 6-10KW 3X230V ELSHEMA F1X45 6-10KW 3X230V BASE+MOTORCONTROL		450133 5	

3X230V 6-10 KW (F1145/F1245)

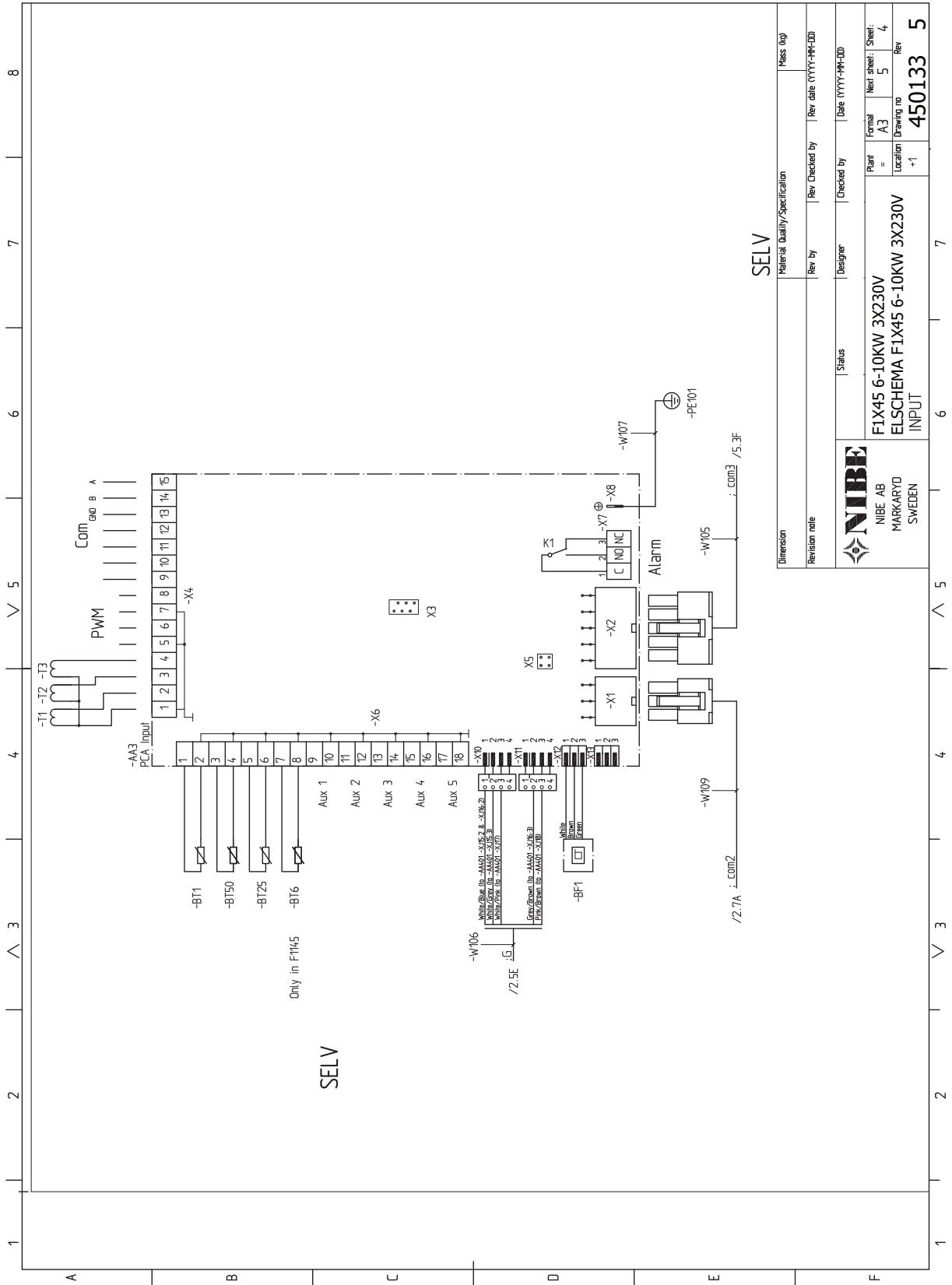

SELV

Dimension	Material Quality/Specification		Mass (kg)
Revision note	Rev by	Rev Checked by	Rev Date (YYYY-MM-DD)
 NIBE AB MARKARYD SWEDEN	Status	Designer	Checked by
	Date (YYYY-MM-DD)		Formal
	Plant =		Formal sheet / Sheet
	Location		Drawing no
+1		450133	5

3X230V 6-10 KW (F1145/F1245)

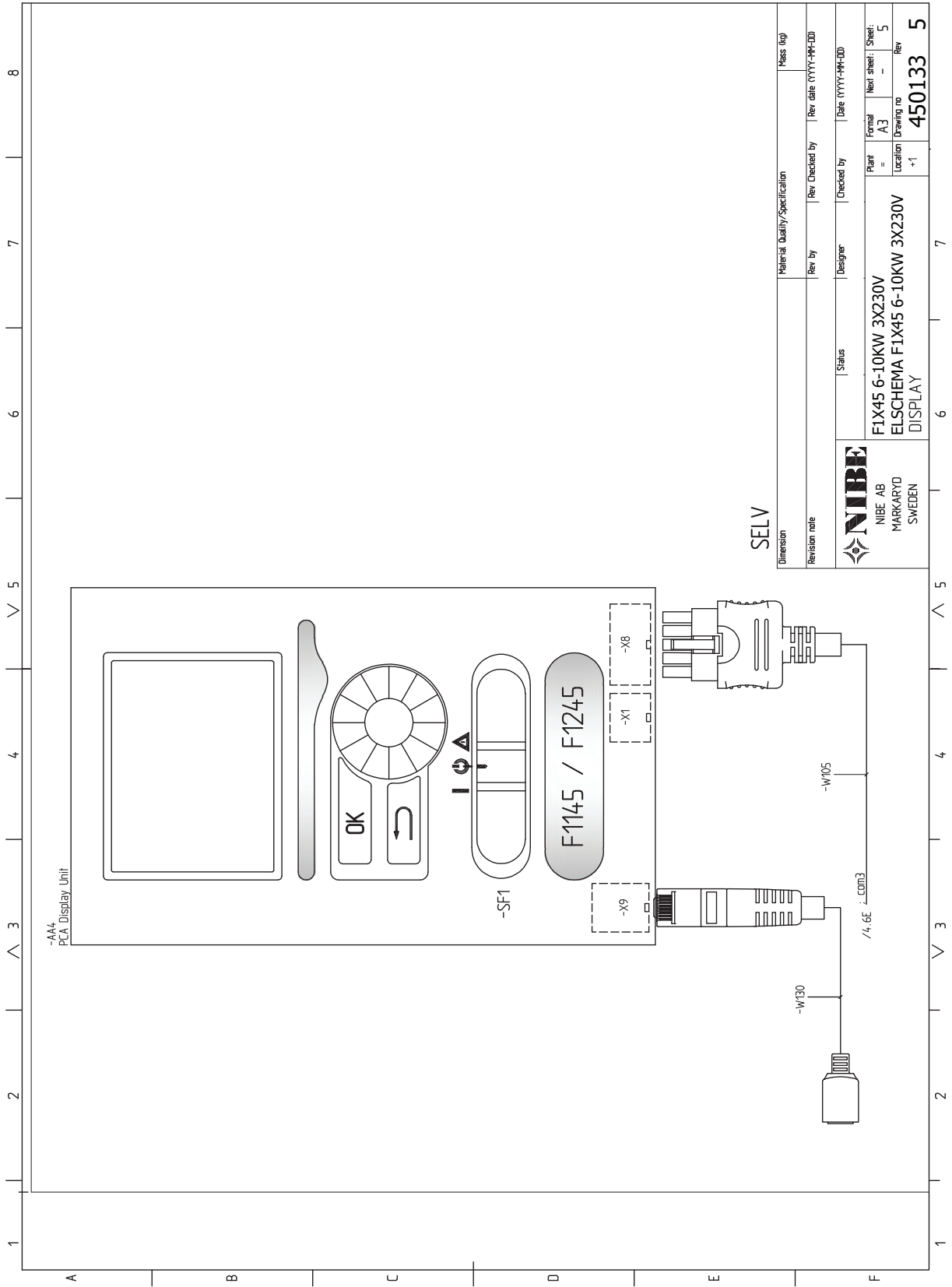

SELV

Dimension	Material Quality/Specification	Mass (kg)
Revision note	Rev. by	Rev. Checked by
 NIBE AB MARKARYD SWEDEN	Designer	Checked by
	Status	Date (YYYY-MM-DD)
F1X45 6-10KW 3X230V ELSHEMA F1X45 6-10KW 3X230V DISPLAY		Plant = A3 Location Drawing no +1 Form sheet: 5 Next sheet: -- Rev 450133 5

3X400V 6-10 KW (F1145/F1245)

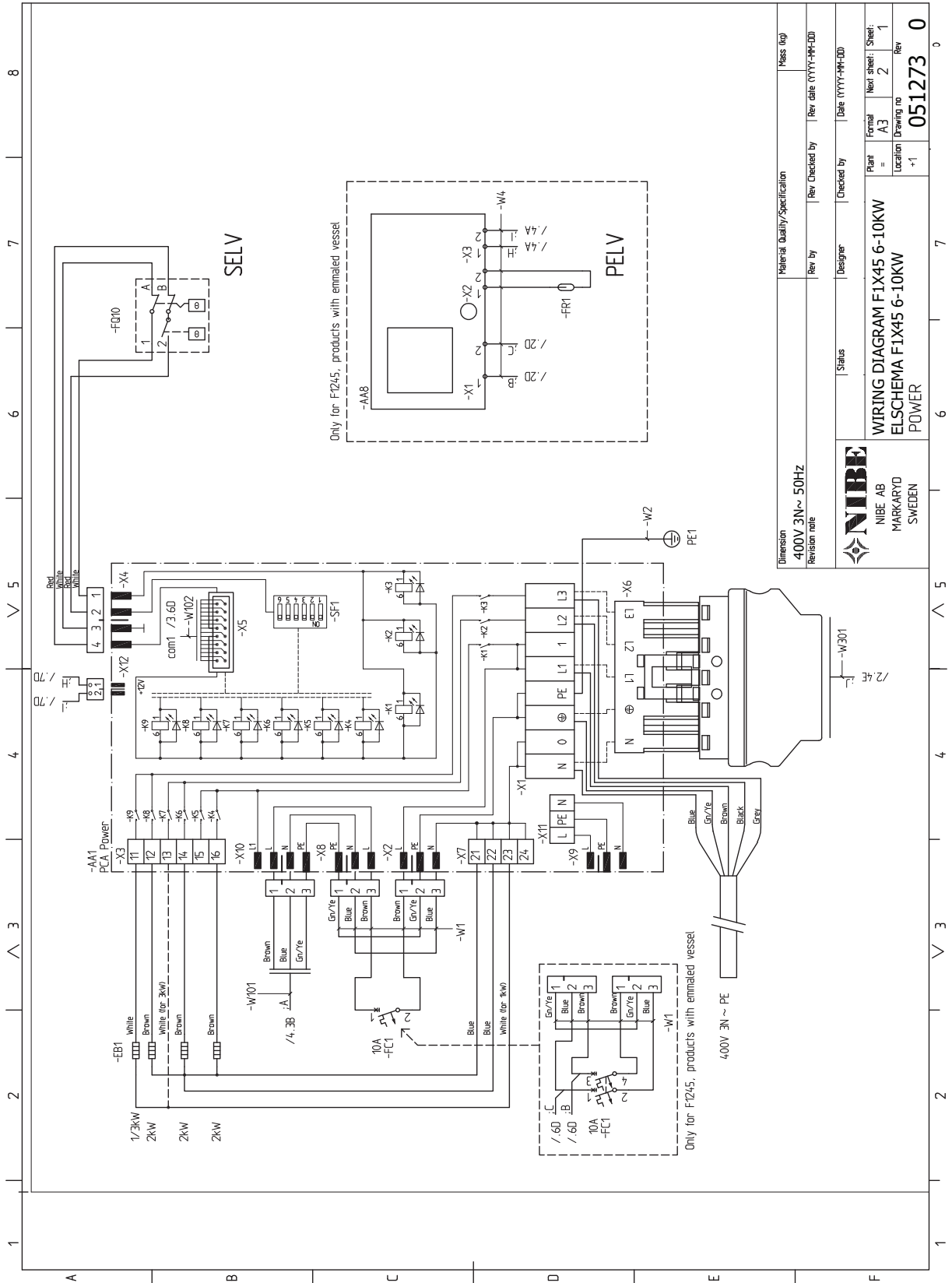

Dimension	Material Quality/Specification	Mass (kg)
Revision note	400V 3N~ 50Hz	
Revised by	Rev. Checked by	Rev. Date (YYYY-MM-DD)
Designer	Checked by	Date (YYYY-MM-DD)
Status	Plant	Formal
	Markaryd	A3
	Sweden	Next sheet: 1
		Location
		Drawing no
		Rev
		051273
		0



WIRING DIAGRAM FIX45 6-10KW
ELSCHEMA FIX45 6-10KW
POWER

3X400V 6-10 KW (F1145/F1245)

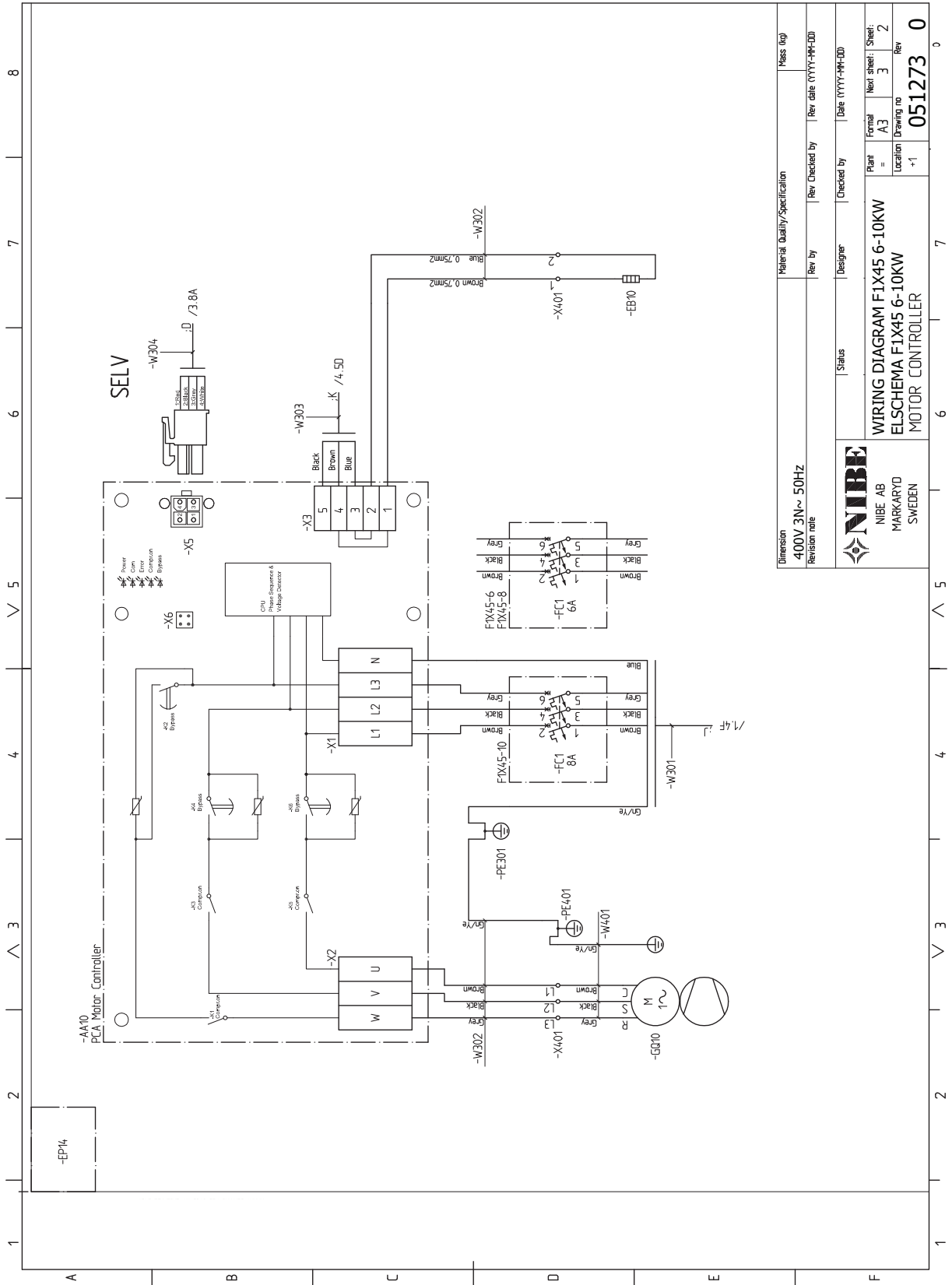

Dimension	Material Quality/Specification	Mass (kg)
400V 3N~ 50Hz		
Revision note	Rev by	Rev Checked by
	Designer	Checked by
	Status	Date (YYYY-MM-DD)
NIBE	Plant =	Formal sheet / Sheet
NIBE AB	WIRING DIAGRAM FLX45 6-10KW	A3 / 3
MARKARYD	ELSCHEMA F1X45 6-10KW	Location Drawing no
SWEDEN	MOTOR CONTROLLER	+1 / 051273
		Rev
		0

3X400V 6-10 KW (F1145/F1245)

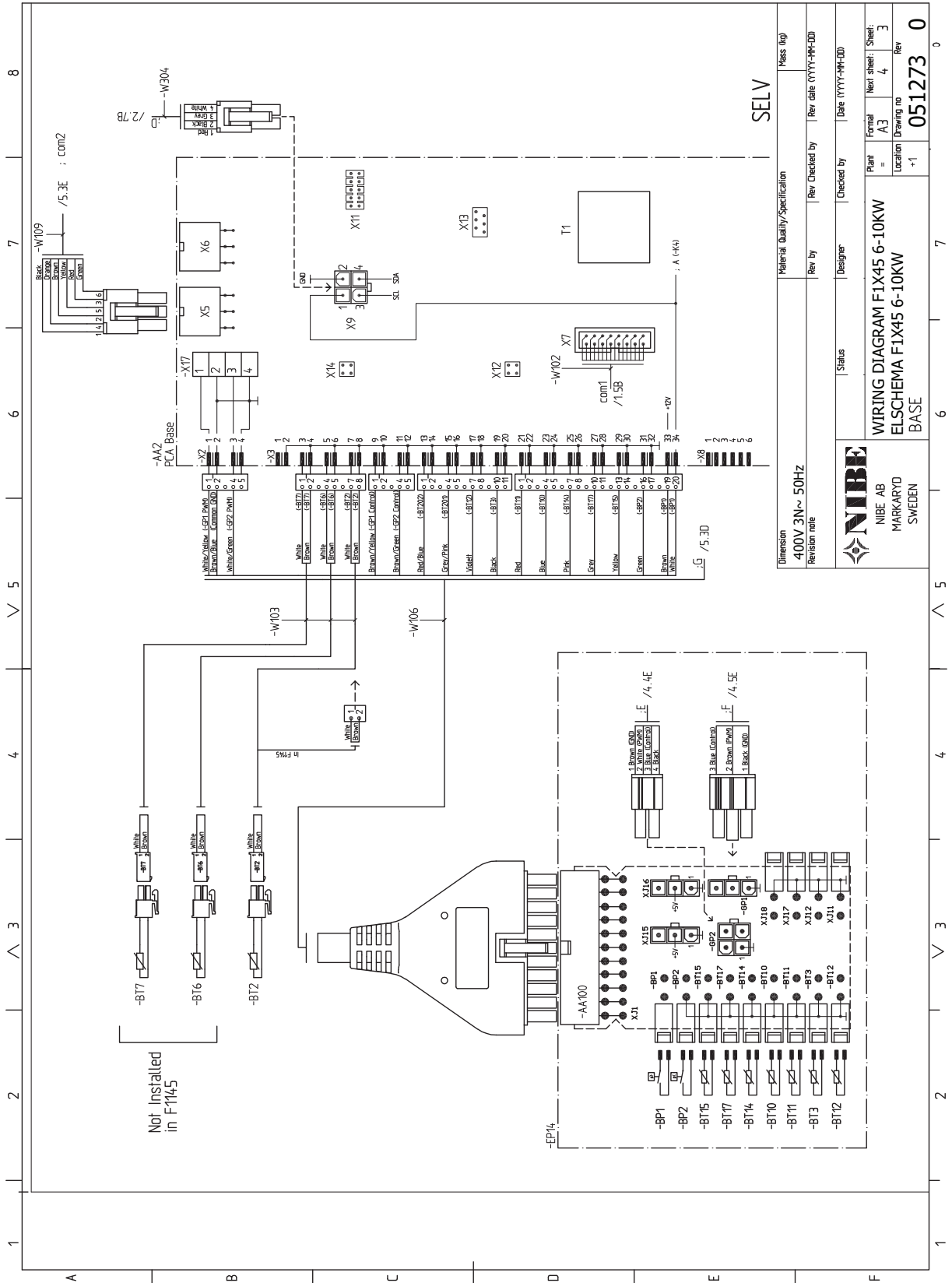

SELV

Dimension	400V 3N~ 50Hz
Revision note	
Material Quality/Specification	
Rev by	Rev Checked by
Designer	Checked by
Status	Date (YYYY-MM-DD)
Plant	Formal
Location	Next sheet / Sheet
+1	4 / 3
051273	Drawing no
0	Rev

NIBE
 NIBE AB
 MARKARYD
 SWEDEN

WIRING DIAGRAM FIX45 6-10KW
 ELSCHHEMA FIX45 6-10KW
 BASE

3X400V 6-10 KW (F1145/F1245)

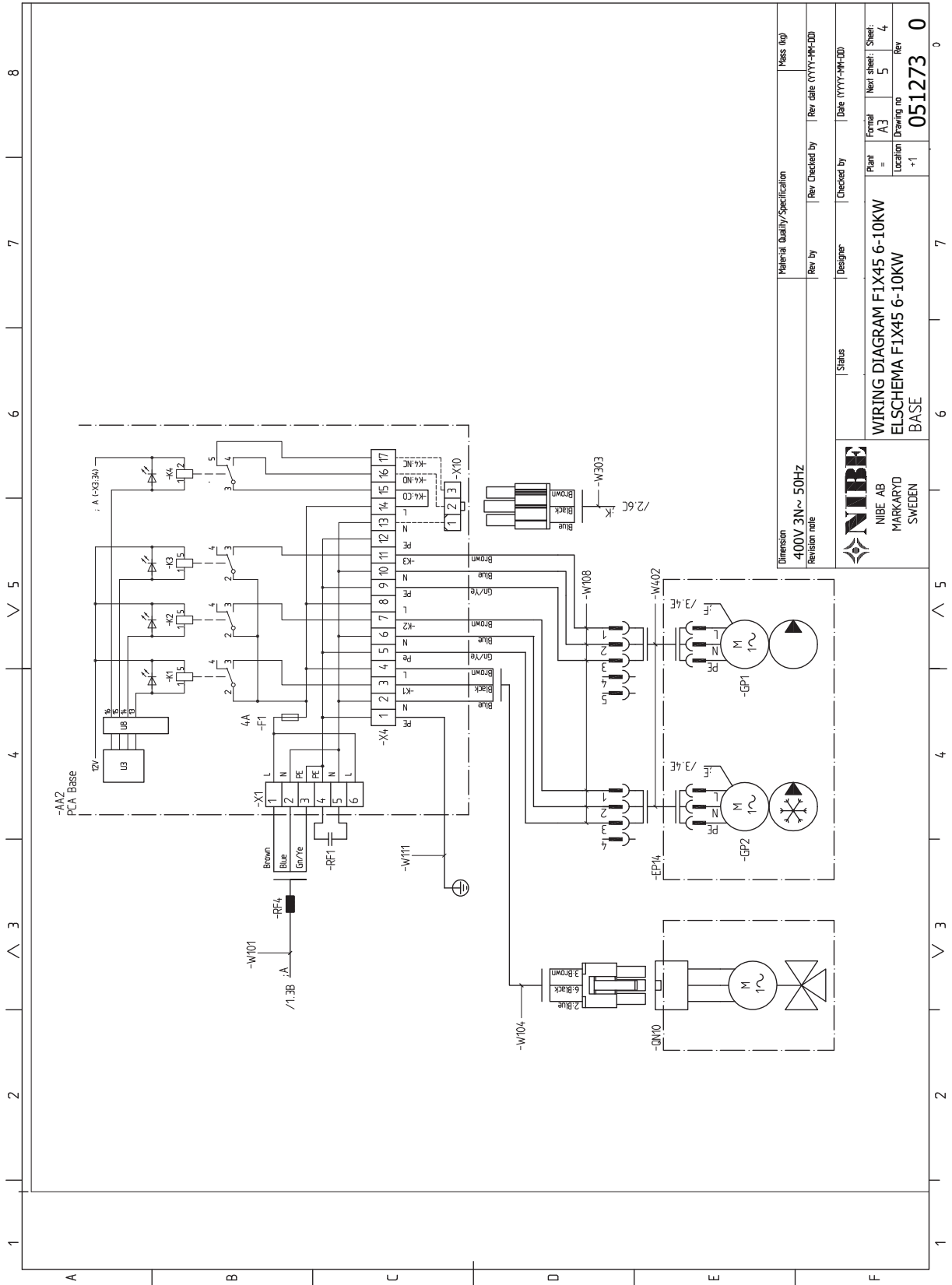

Dimension	Material Quality/Specification	Mass (kg)
400V 3N~ 50Hz		
Revision note	Rev. by	Rev. Checked by
	Designer	Checked by
	Status	Date (YYYY-MM-DD)
 NIBE AB MARKARYD SWEDEN	WIRING DIAGRAM FLX45 6-10KW	
	ELSCHEMA FLX45 6-10KW	
	Plant =	Formal A3
	Location +1	Next sheet: 5
	Drawing no	Rev
	051273	0

3X400V 6-10 KW (F1145/F1245)

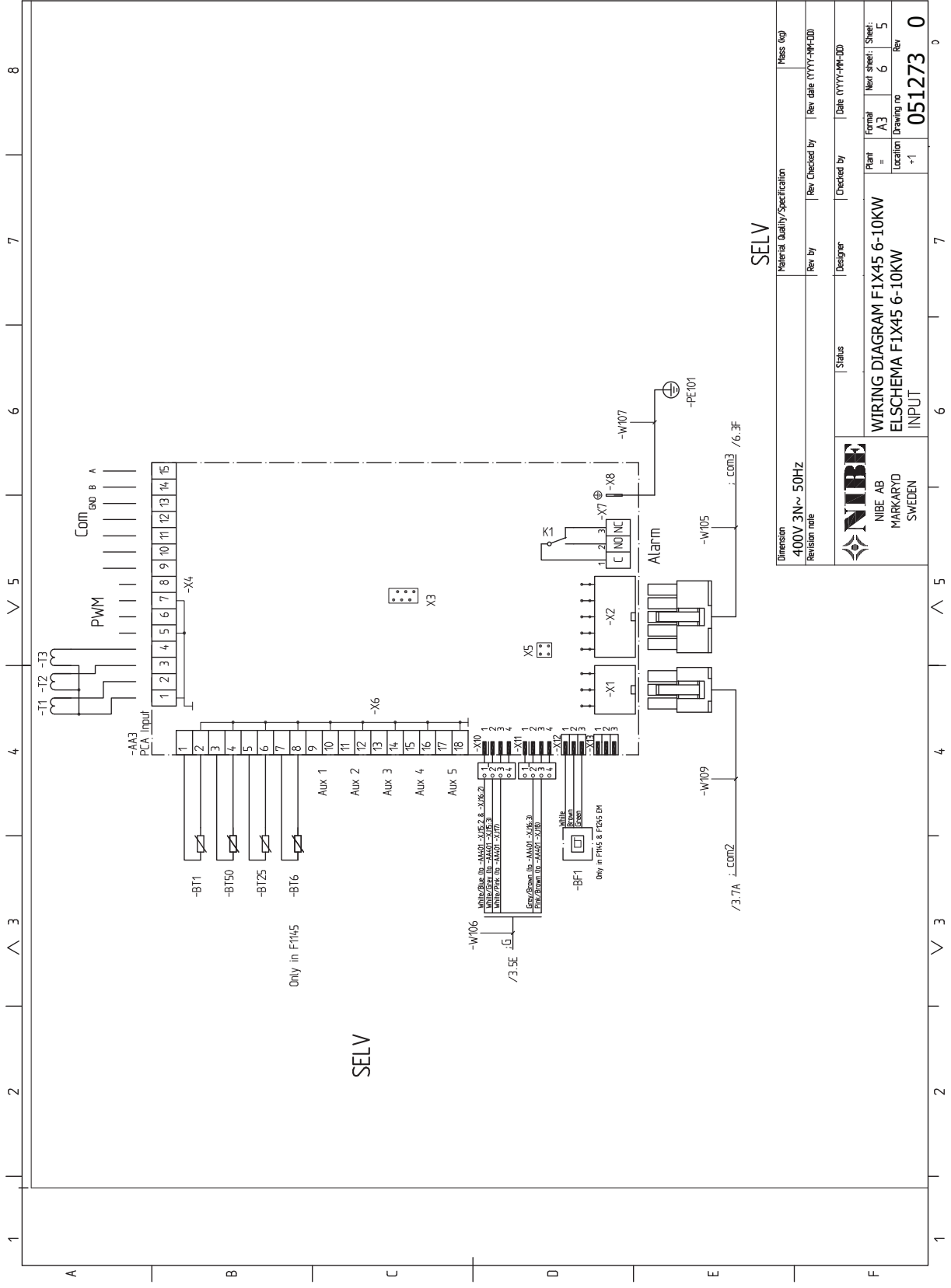

SELV

Dimension	Material Quality/Specification	Mass (kg)	
400V 3N~ 50Hz			
Revision note	Rev by	Rev Checked by	
	Designer	Checked by	
	Status	Date (YYYY-MM-DD)	
 NIBE AB MARKARYD SWEDEN	Plant	Formal	Next sheet / Sheet
	WIRING DIAGRAM FLX45 6-10KW	A3	6 / 5
	ELSCHEMA F1X45 6-10KW	Location	Drawing no
	INPUT	+1	051273 0

3X400V 6-10 KW (F1145/F1245)

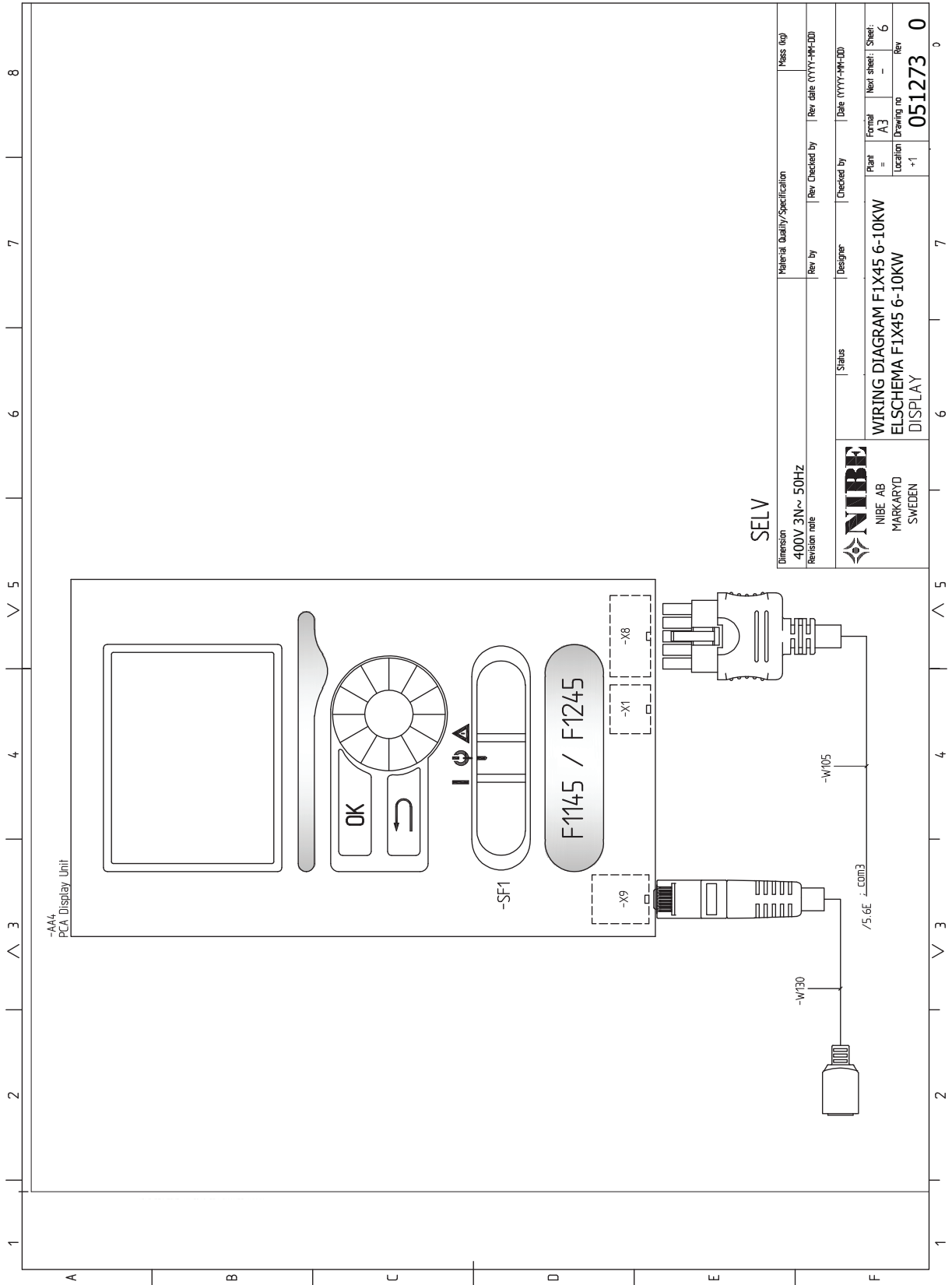

3X400V 12 KW (F1145/F1245)

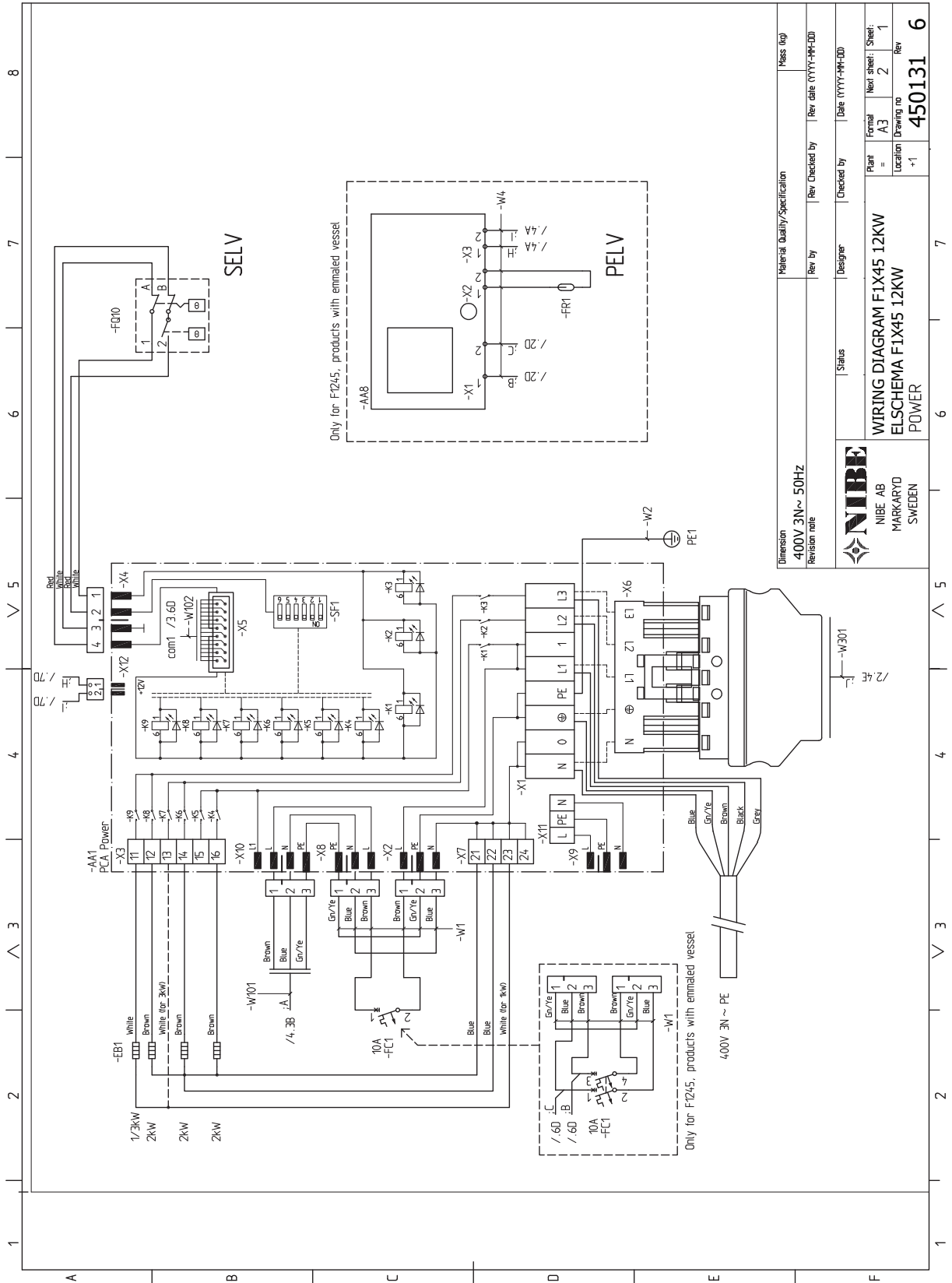

Dimension	Material Quality/Specification	Mass (kg)
Revision note	400V 3N~ 50Hz	
Revised by	Rev. Checked by	Rev. Date (YYYY-MM-DD)
Designer	Checked by	Date (YYYY-MM-DD)
NIBE		
NIBE AB MARKARYD SWEDEN		
WIRING DIAGRAM FIX45 12KW ELSCHEMA FIX45 12KW POWER		
Plant	Formal	Next sheet / Sheet
Location	A3	2 / 1
Drawing no	+1	450131
Rev		6

3X400V 12 KW (F1145/F1245)

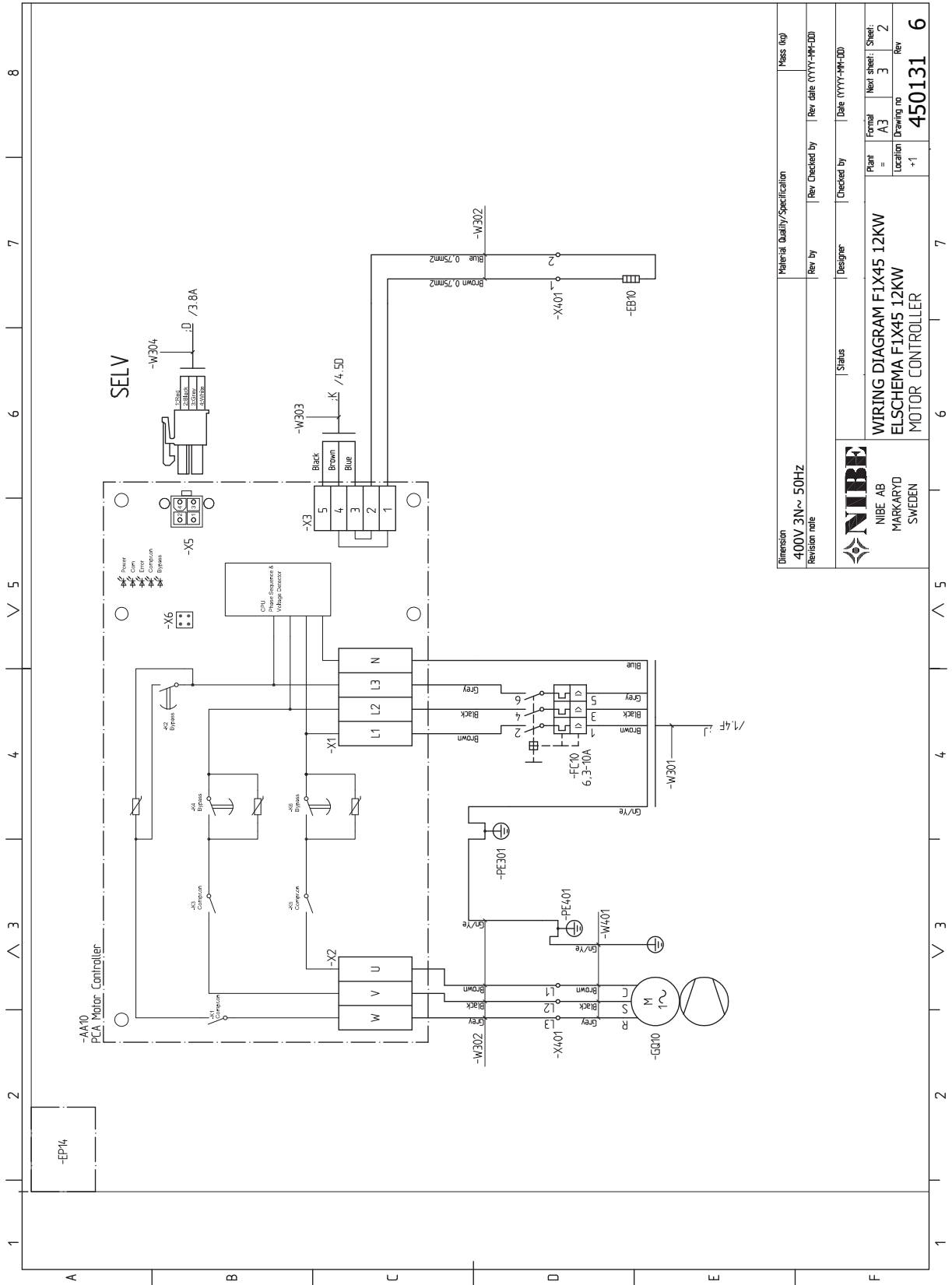

Dimension	Material Quality/Specification	Mass (kg)
400V 3N~ 50Hz		
Revision note	Rev by	Rev Checked by
	Designer	Checked by
	Status	Date (YYYY-MM-DD)
 NIBE AB MARKARYD SWEDEN	WIRING DIAGRAM FLX45 12KW ELSCHEMA F1X45 12KW MOTOR CONTROLLER	
	Plant =	Formal
	Location	Next sheet / Sheet
	+1	3 / 2
	450131	6

3X400V 12 KW (F1145/F1245)

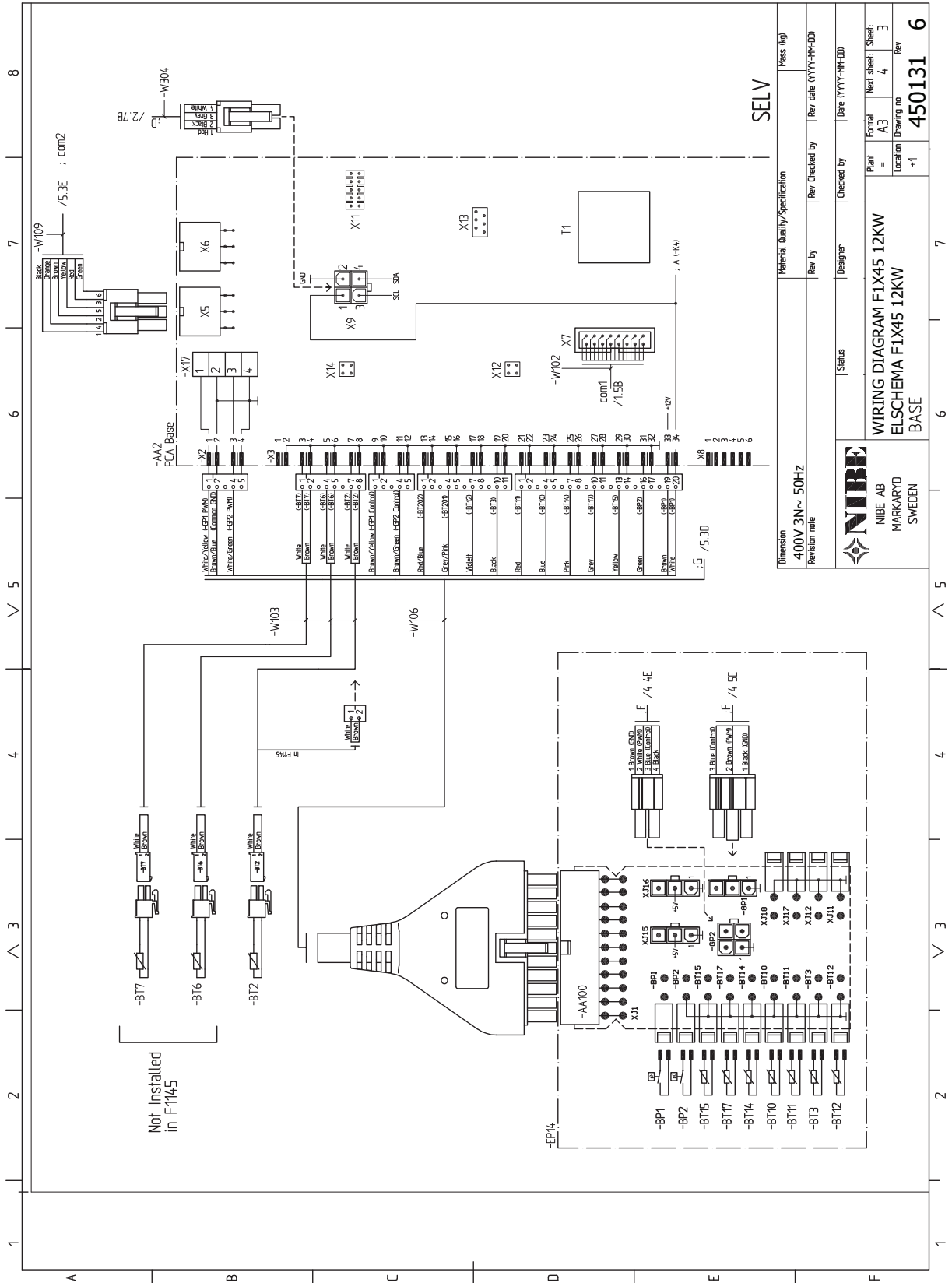

SELV

Dimension	400V 3N~ 50Hz	Material Quality/Specification	Mess (kg)
Revision note		Rev by	Rev Checked by
		Designer	Date (YYYY-MM-DD)
		Status	Rev Date (YYYY-MM-DD)
NIBE			
NIBE AB			
MARKARYD			
SWEDEN			
WIRING DIAGRAM FIX45 12KW		Plant	Formal
ELSHEMA FIX45 12KW		=	=
BASE		Location	Next sheet / Sheet
+1		450131	4 / 3
6		Rev	6

3X400V 12 KW (F1145/F1245)

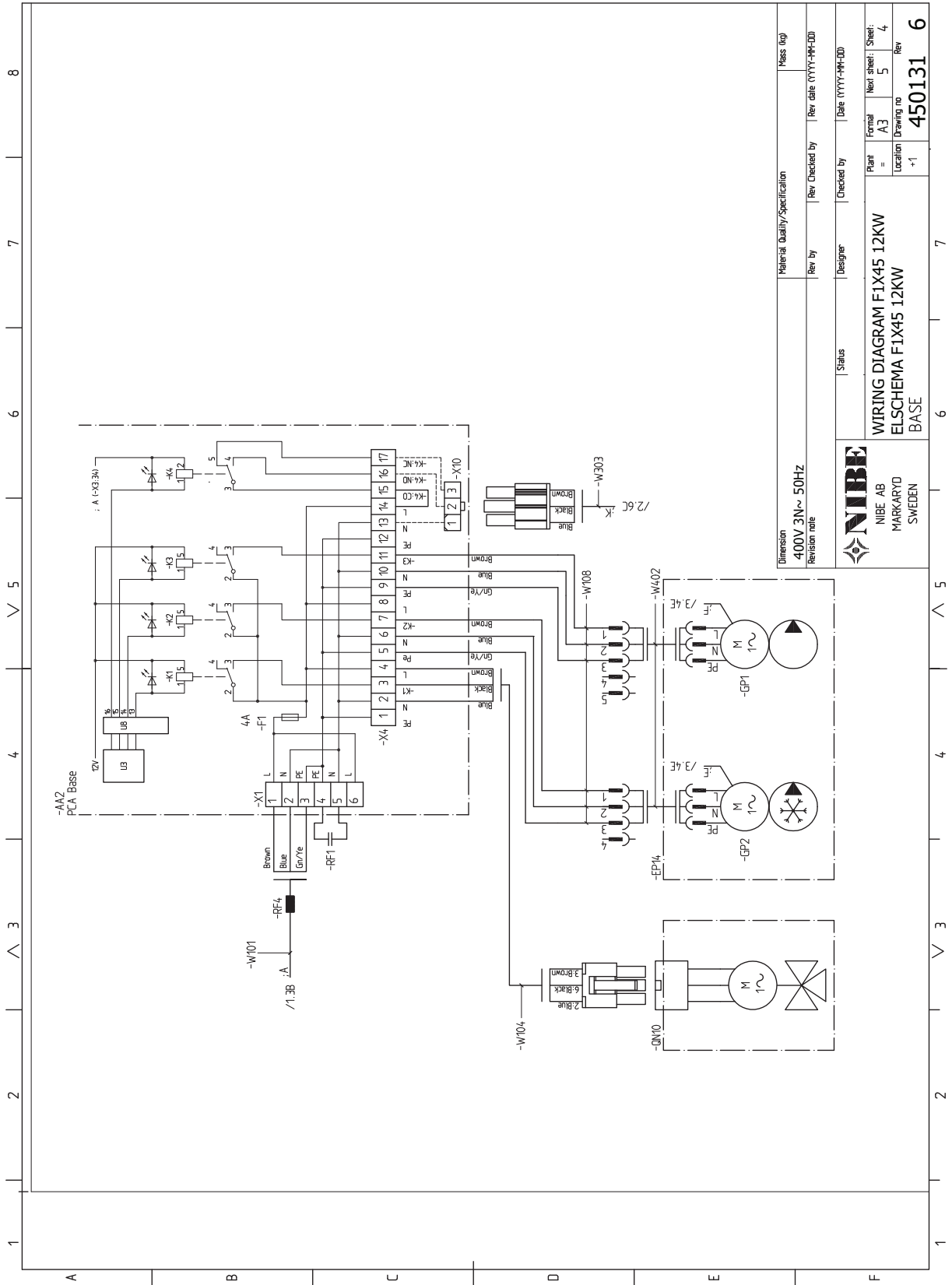

Dimension	Material Quality/Specification	Mass (kg)
Revision note	Rev. by	Rev. Date (YY-MM-DD)
	Rev. Checked by	
	Designer	Checked by
	Status	Date (YYYY-MM-DD)
NIBE		
NIBE AB MARKARYD SWEDEN		
WIRING DIAGRAM FLX45 12KW ELSCHEMA F1X45 12KW		
Plant	Formal	Next sheet / Sheet
=	A3	5 / 4
Location	Drawing no	Rev
+1	450131	6

3X400V 12 KW (F1145/F1245)

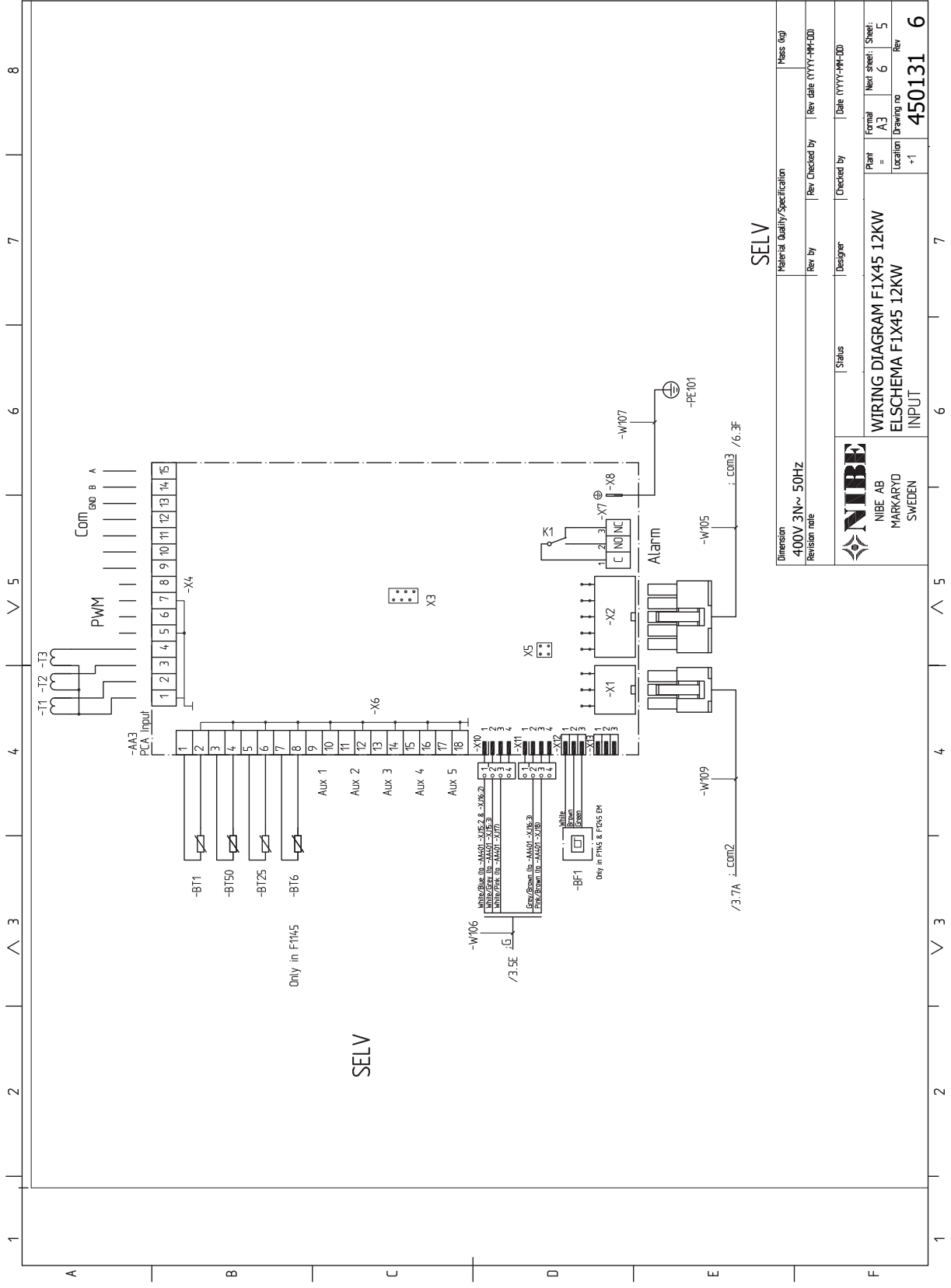

SELV

Dimension	Material Quality/Specification	Mass (kg)
400V 3N~ 50Hz		
Revision note	Rev. by	Rev. Checked by
	Designer	Checked by
	Status	Date (YYYY-MM-DD)
 NIBE AB MARKARYD SWEDEN	Plant	Formal
	=	A3
	WIRING DIAGRAM FLX45 12KW	Next sheet: Sheet
ELSCHEMA F1X45 12KW	Location	6
INPUT	+1	5
	Drawing no	Rev
	450131	6

3X400V 12 KW (F1145/F1245)

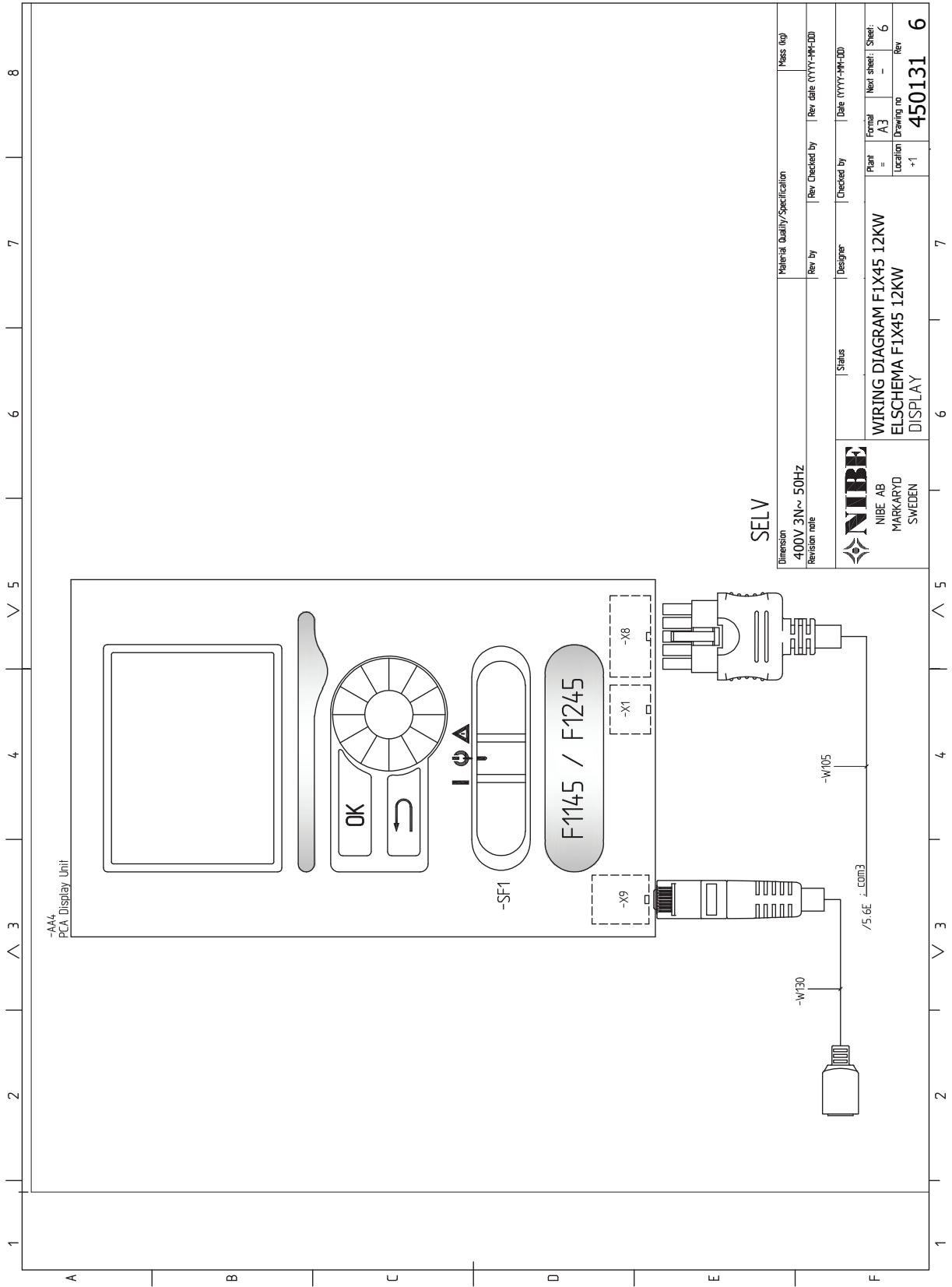

3X400V 15-17 KW (F1145)

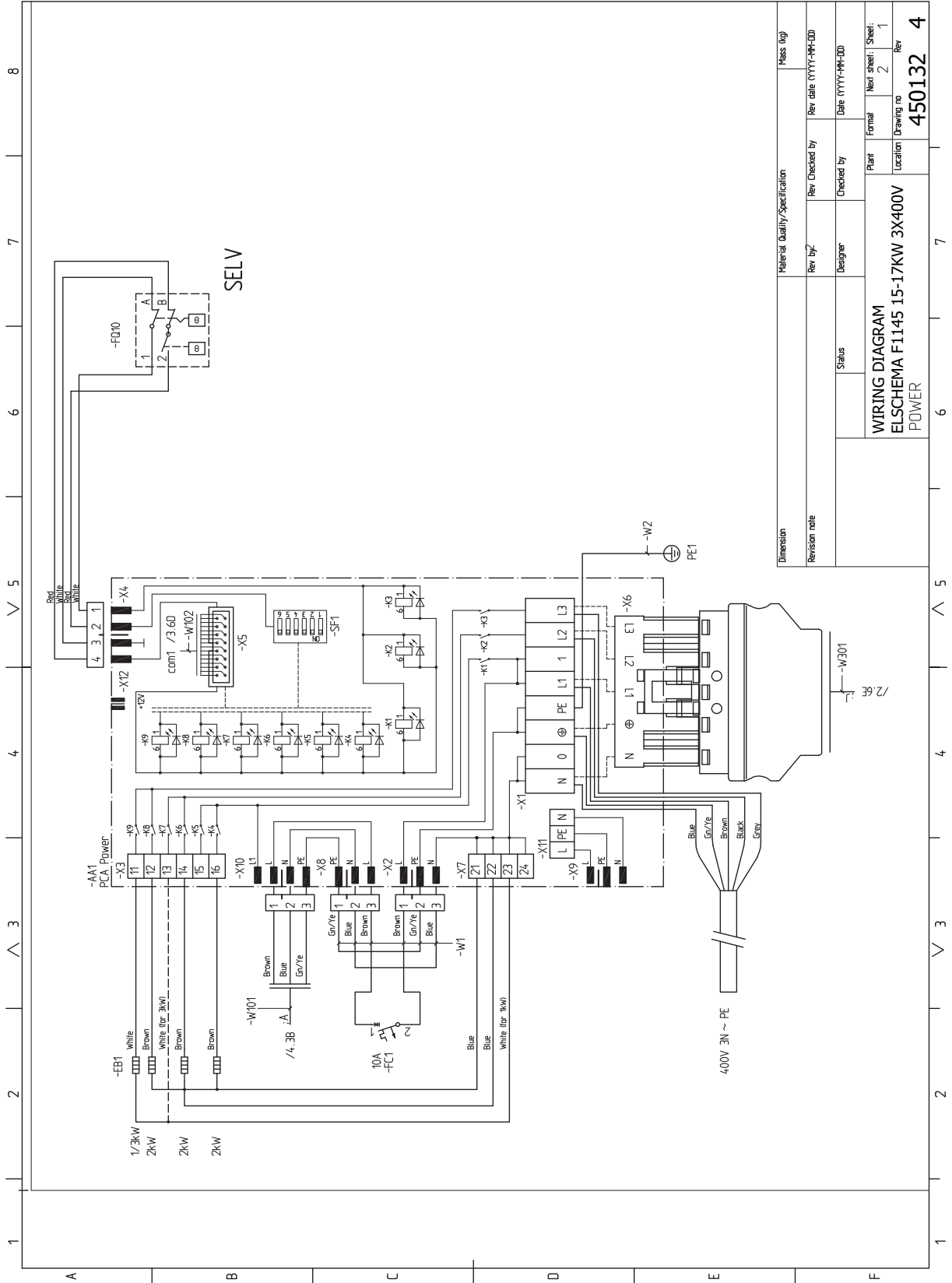

Dimension	Material Quality/Specification	Mass (kg)
Revision note	Rev. by:	Rev. Checked by
	Designer	Checked by
	Status	Date (YYYY-MM-DD)
WIRING DIAGRAM		Plant
ELSCHEMA F1145 15-17KW 3X400V		Location
POWER		Drawing no
		450132
		Rev
		4

3X400V 15-17 KW (F1145)

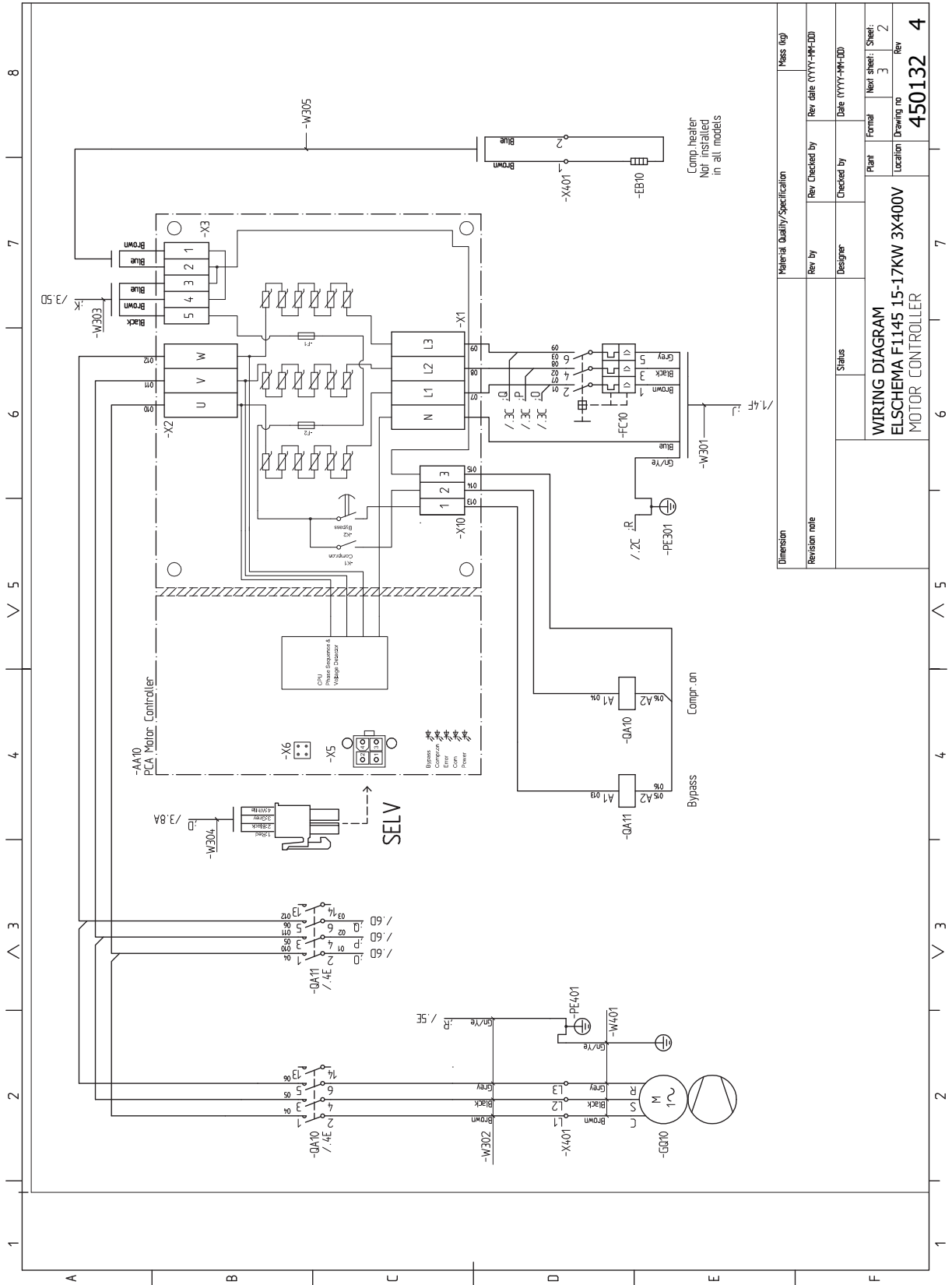

Material Quality/Specification		Mass (kg)	
Rev by	Rev Checked by	Rev date (YYYY-MM-DD)	
Designer	Checked by	Date (YYYY-MM-DD)	
Status	Plant	Plant	Sheet: 2
	Location	Location	Sheet: 3
		Drawing no	Sheet: 4
			Rev
			450132
			4

WIRING DIAGRAM
ELSCHEMA F1145 15-17KW 3X400V
MOTOR CONTROLLER

3X400V 15-17 KW (F1145)

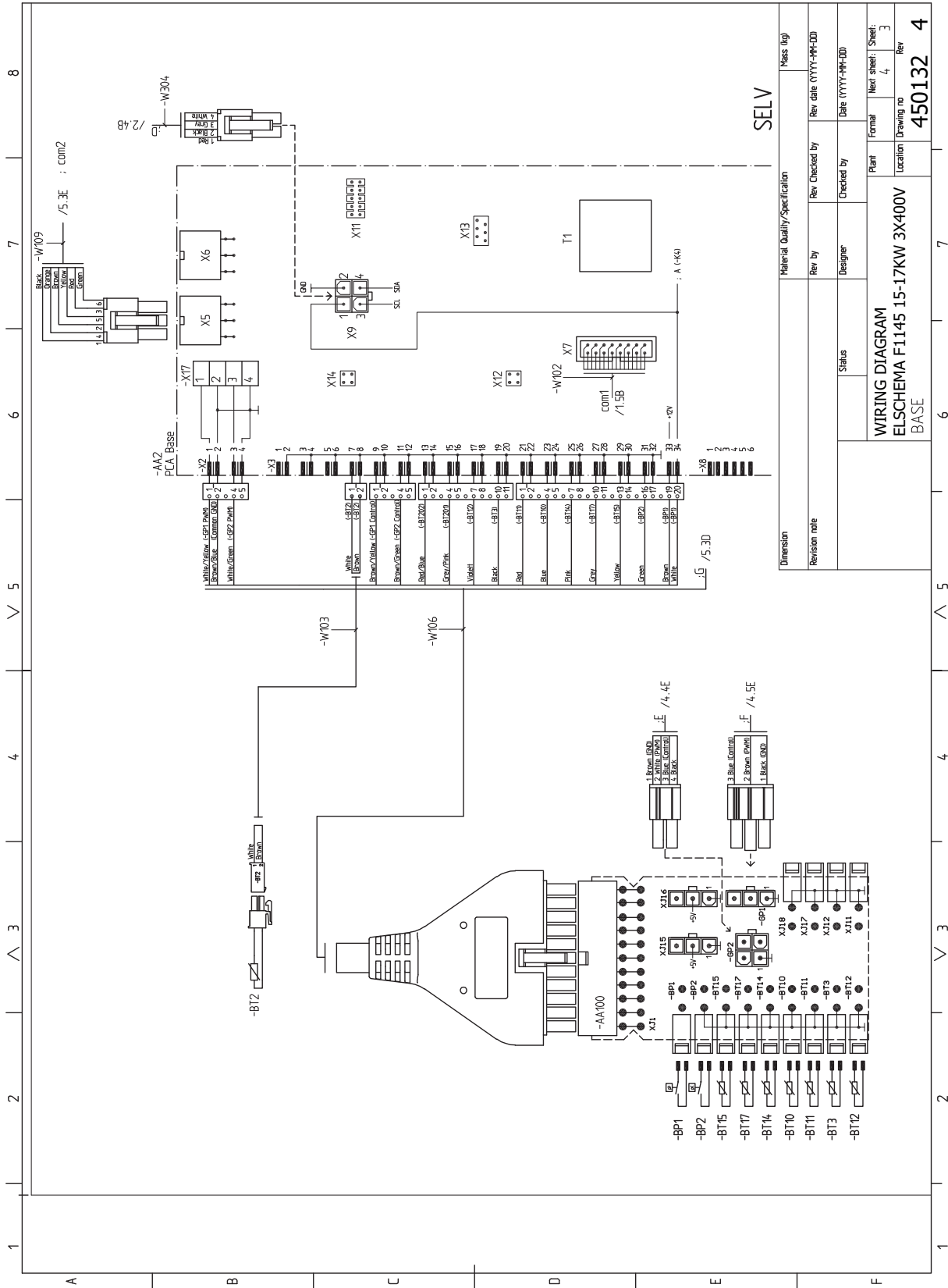

3X400V 15-17 KW (F1145)

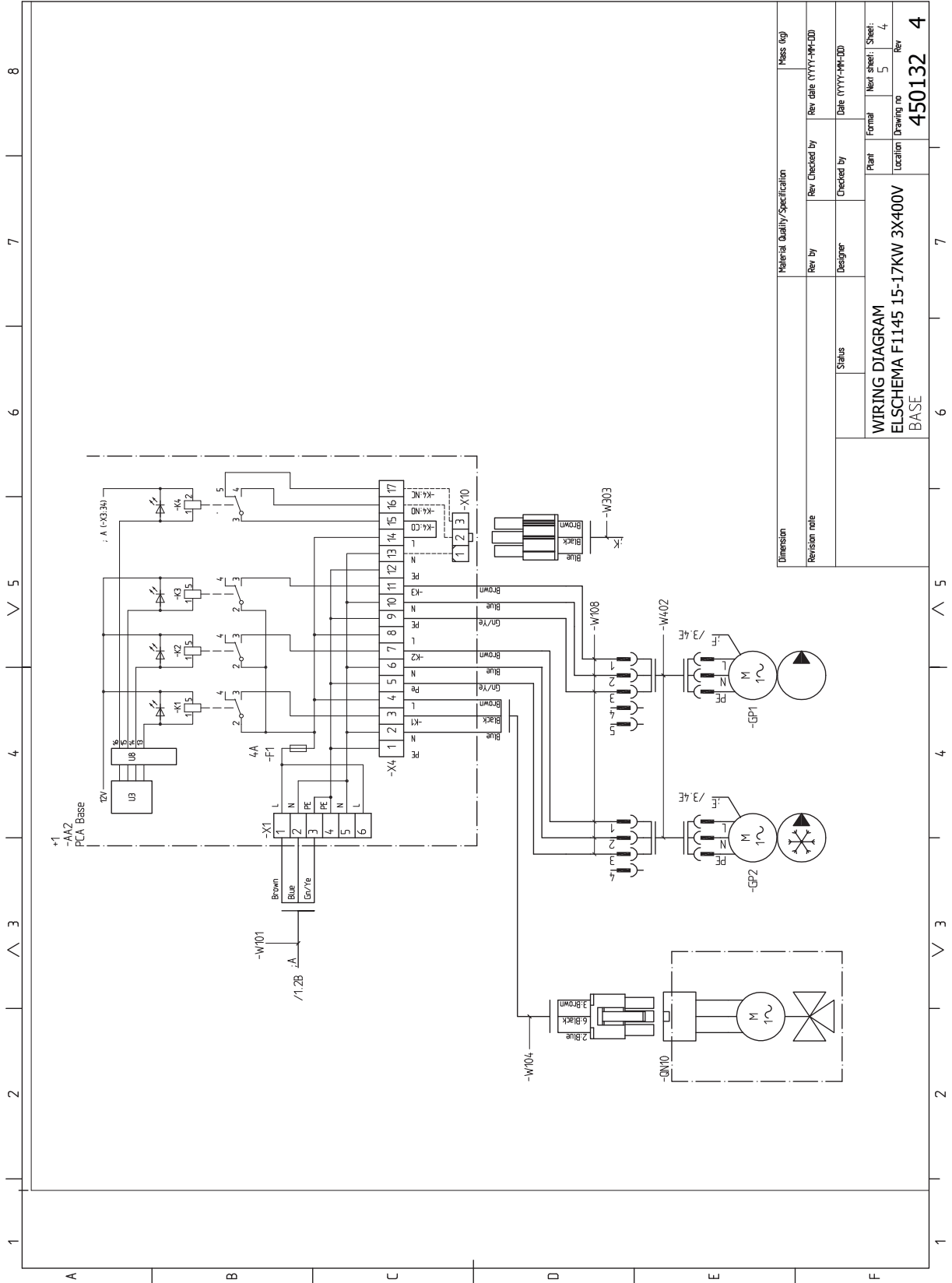

Dimension		Material Quality/Specification		Mass (kg)
Revision note		Rev. by	Rev. Checked by	Rev. date (YYYY-MM-DD)
Status		Designer	Checked by	Date (YYYY-MM-DD)
Plant		Format	Plant	Next sheet: Sheet: 4
Location		Drawing no	Location	Rev
BASE		450132	4	4

3X400V 15-17 KW (F1145)

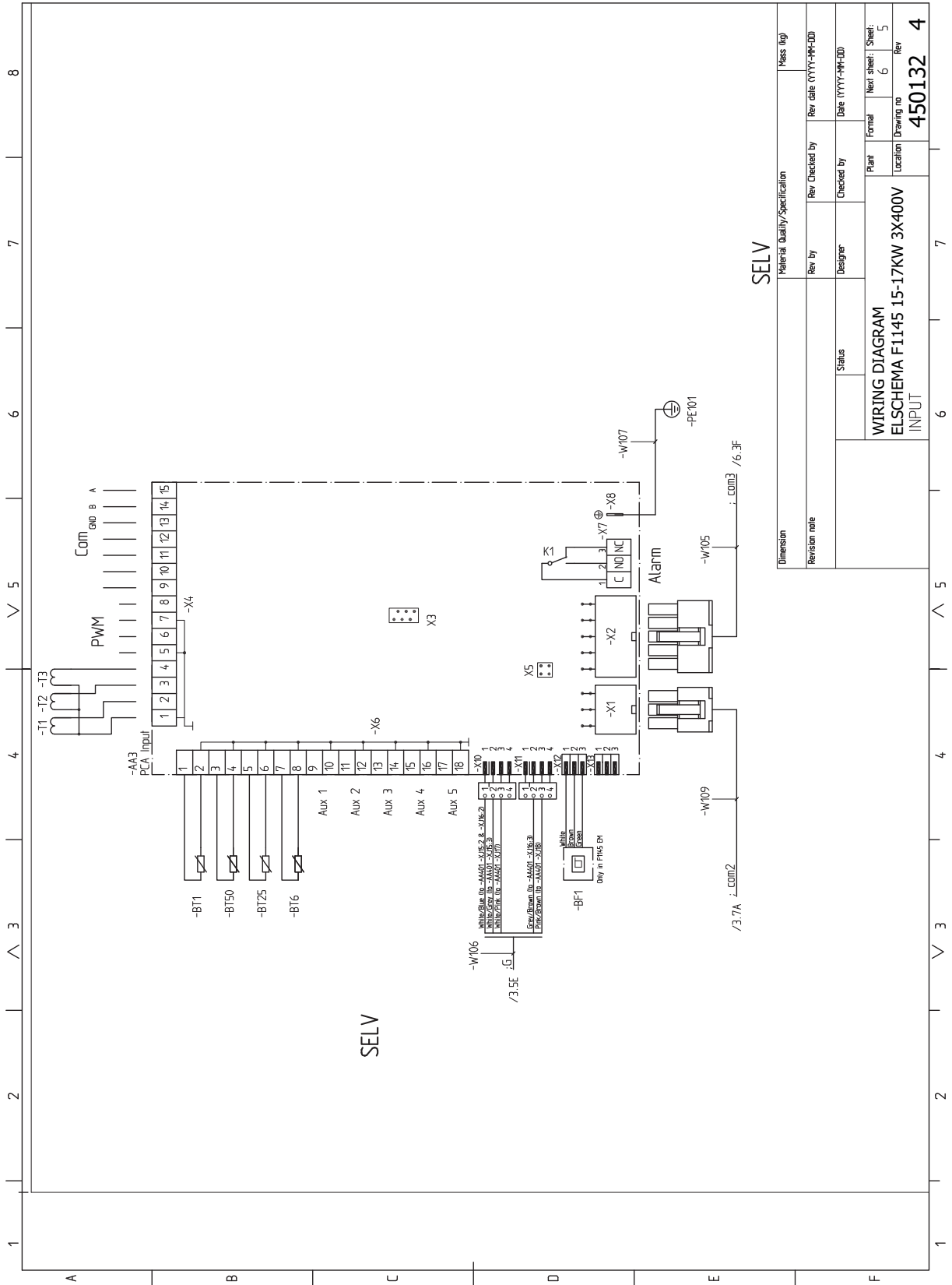

SELV

Material Quality/Specification		Mass (kg)	
Rev. by	Rev. Checked by	Rev. date (YYYY-MM-DD)	
Designer	Checked by	Date (YYYY-MM-DD)	
Status	Plant	Format	Next sheet: Sheet: 5
WIRING DIAGRAM ELSCHEMA F1145 15-17KW 3X400V INPUT		Location	Drawing no
			450132
		Rev	4

3X400V 15-17 KW (F1145)

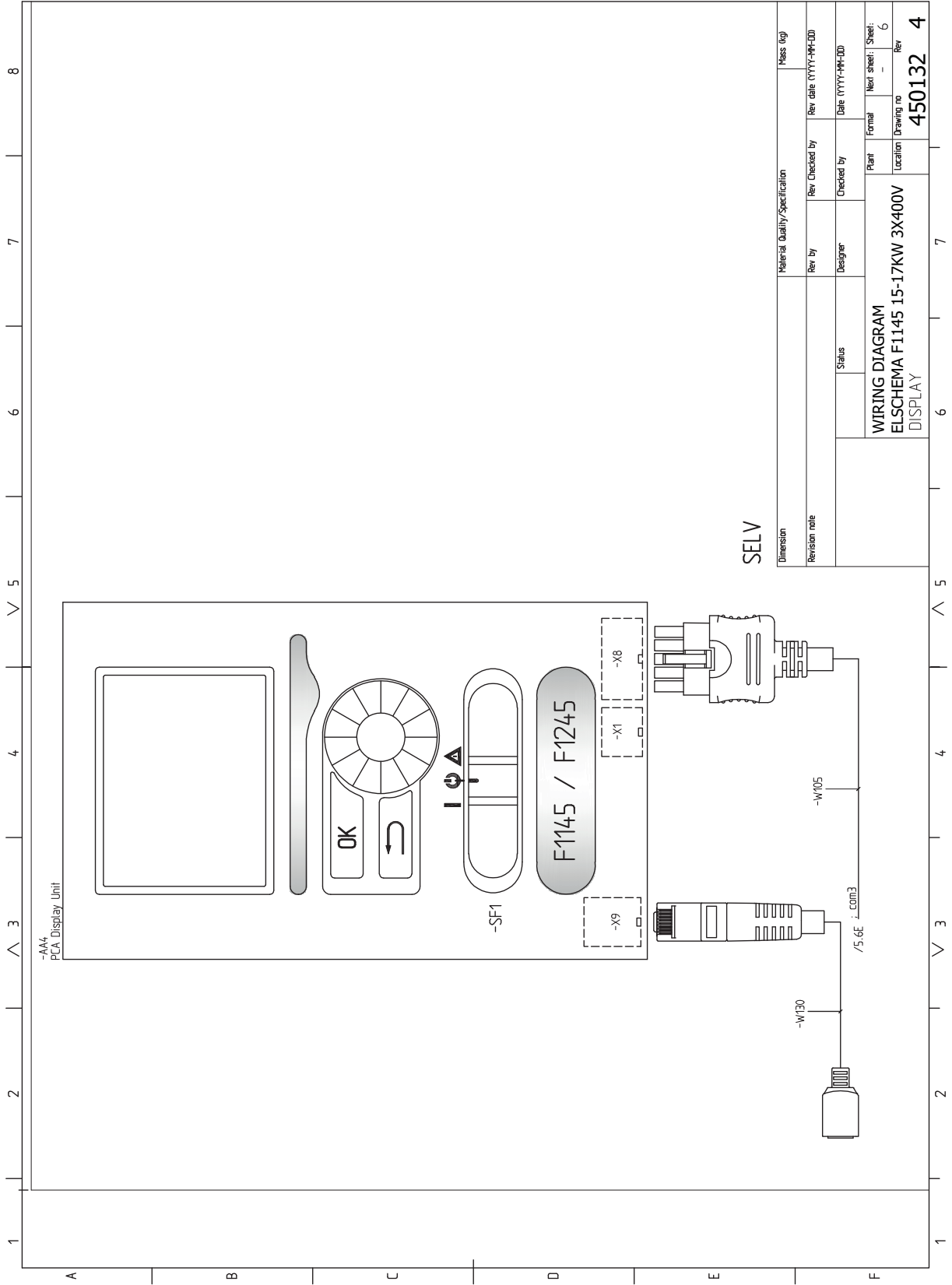

SELV

Material Quality/Specification		Material Quality/Specification		Material Quality/Specification	
Dimension	Rev. Checked by	Rev. Checked by	Rev. Checked by	Rev. Checked by	Rev. Checked by
Revision note	Designer	Designer	Designer	Designer	Designer
Status	Checked by	Checked by	Checked by	Checked by	Checked by
Plant	Plant	Plant	Plant	Plant	Plant
Format	Format	Format	Format	Format	Format
Next sheet	Next sheet	Next sheet	Next sheet	Next sheet	Next sheet
Sheet	Sheet	Sheet	Sheet	Sheet	Sheet
6	6	6	6	6	6
Location	Location	Location	Location	Location	Location
450132	450132	450132	450132	450132	450132
4	4	4	4	4	4

NIBE Energy Systems
Hannabadsvägen 5
Box 14
SE-285 21 Markaryd
info@nibe.se
nibe.eu

WHB EN 2451-1 831481

This is a publication from NIBE Energy Systems. All product illustrations, facts and data are based on the available information at the time of the publication's approval.

NIBE Energy Systems makes reservations for any factual or printing errors in this publication.

©2025 NIBE ENERGY SYSTEMS

