

Ground source heat pump **NIBE F1253**

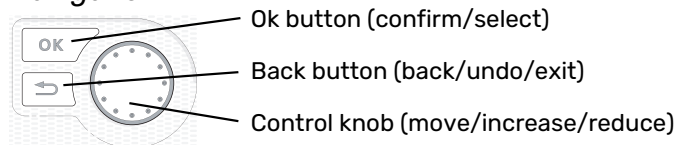

Quick guide

Navigation



A detailed explanation of the button functions can be found on page 35.

How to scroll through menus and make different settings is described on page 37.

Set the indoor climate

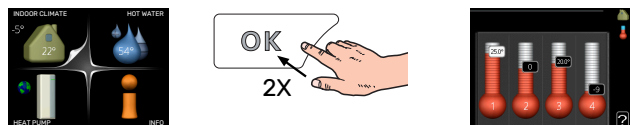

The mode for setting the indoor temperature is accessed by pressing the OK button twice, when in the start mode in the main menu.

Increase hot water volume



To temporarily increase the amount of hot water, first turn the control knob to mark menu 2 (water droplet) and then press the OK button twice.

Table of Contents

1	Important information	4	Range of services	34
	Safety information	4	myUplink PRO	34
	Symbols	4		
	Marking	5	8 Control - Introduction	35
	Serial number	5	Display unit	35
	Recovery	5	Menu system	35
	Environmental information	5	9 Control - Menus	39
	Inspection of the installation	6	Menu 1 - INDOOR CLIMATE	39
2	Delivery and handling	7	Menu 2 - HOT WATER	39
	Transport	7	Menu 3 - INFO	39
	Assembly	7	Menu 4 - HEAT PUMP	39
	Supplied components	8	Menu 5 - SERVICE	41
	Removing the covers	8	10 Service	52
	Removing parts of the insulation	9	Service actions	52
3	The heat pump design	11	11 Disturbances in comfort	58
	General	11	Manage alarm	58
	Distribution boxes	13	Troubleshooting	58
	Cooling module (EP14)	14	12 Accessories	60
4	Pipe connections	15	13 Technical data	62
	General	15	Dimensions	62
	Dimensions and pipe connections	16	Electrical data	63
	Brine side	17	Technical specifications	64
	Climate system	18	Energy labelling	68
	Cold and hot water	18	Electrical circuit diagram	74
	Installation alternative	18	Item register	86
5	Electrical connections	20	Contact information	91
	General	20		
	Connections	22		
	Settings	23		
	Optional connections	25		
	Connecting accessories	28		
6	Commissioning and adjusting	29		
	Preparations	29		
	Filling and venting	29		
	Start-up and inspection	30		
	Setting the heating curve	32		
7	myUplink	34		
	Specification	34		
	Connection	34		

Important information

Safety information

This manual describes installation and service procedures for implementation by specialists.

The manual must be left with the customer.

For the latest version of the product's documentation, see nibe.eu.

This appliance can be used by children aged from 8 years and above and persons with reduced physical, sensory or mental capabilities or lack of experience and knowledge if they have been given supervision or instruction concerning use of the appliance in a safe way and understand the hazards involved. Children shall not play with the appliance. Cleaning and user maintenance shall not be made by children without supervision.

This is an original manual. It may not be translated without the approval of NIBE.

Rights to make any design or technical modifications are reserved.

©NIBE 2024.

		Min	Max
<i>System pressure</i>			
Heating medium	MPa (bar)	0.5 (0.5)	0.45 (4.5)
Brine	MPa (bar)	0.05 (0.5)	0.45 (4.5)
Domestic water	MPa (bar)	0.01 (0.1)	1.0 (10) ¹
<i>Temperature</i>			
Heating medium ²	°C	3	70
Brine	°C	-8	30
Domestic water ²	°C	3	70

¹ UK: 0.6 (6.0 bar)

² Compressor and additional heat

F1253 must be installed via an isolator switch. The cable area has to be dimensioned based on the fuse rating used.

Do not start F1253 if there is a risk that the water in the system has frozen.

Water may drip from the safety valve's overflow pipe. The overflow pipe must be routed to a suitable drain, to prevent hot water splashes from causing harm. The overflow pipe must be inclined along its entire length to prevent pockets where water can accumulate, and must be frost-proof. The overflow pipe must be at least the same size as the safety valve. The overflow pipe must be visible and its mouth must be open and not placed close to electrical components.

The safety valves must be actuated regularly to remove dirt and to check that they are not blocked.

Electrical installation and wiring must be carried out in accordance with national provisions.

If the supply cable is damaged, only NIBE, its service representative or similar authorised person may replace it to prevent any danger and damage.

Symbols



CAUTION!

This symbol indicates danger to person or machine.



NOTE!

This symbol indicates important information about what you should consider when installing or servicing the installation.



TIP!

This symbol indicates tips on how to facilitate using the product.

Marking

Explanation of symbols that may be present on the product's label(s).



Danger to person or machine.



Read the User Manual.

Serial number

The serial number can be found at the bottom right of the front cover, in the info menu (menu 3.1) and on the type plate (PZ1).

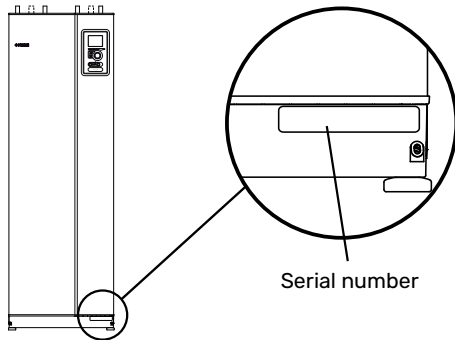

NOTE!

You need the product's (14 digit) serial number for servicing and support.

Recovery



Leave the disposal of the packaging to the installer who installed the product or to special waste stations.

Do not dispose of used products with normal household waste. It must be disposed of at a special waste station or dealer who provides this type of service.

Improper disposal of the product by the user results in administrative penalties in accordance with current legislation.

Environmental information

F-GAS REGULATION (EU) NO. 517/2014

This unit contains a fluorinated greenhouse gas that is covered by the Kyoto agreement.

The equipment contains R407C, a fluorinated greenhouse gas with a GWP value (Global Warming Potential) of 1,774.

Do not release R407C into the atmosphere.

Inspection of the installation

Current regulations require the heating installation to be inspected before it is commissioned. The inspection must be carried out by a suitably qualified person.

In addition, fill in the page for the installation data in the User Manual.

✓	Description	Notes	Signature	Date
	Brine (page 17)			
	System flushed			
	System vented			
	Antifreeze			
	Level/Expansion vessel			
	Filterball (particle filter)			
	Safety valve			
	Shut off valves			
	Circulation pump setting			
	Climate system (page 18)			
	System flushed			
	System vented			
	Expansion vessel			
	Filterball (particle filter)			
	Safety valve			
	Shut off valves			
	Circulation pump setting			
	Electricity (page 20)			
	Connections			
	Main voltage			
	Phase voltage			
	Fuses heat pump			
	Fuses property			
	Outside sensor			
	Room sensor			
	Current sensor			
	Safety breaker			
	Earth circuit-breaker			
	Setting of emergency mode thermostat			

Delivery and handling

Transport

F1253 should be transported and stored vertically in a dry place. When being moved into a building, F1253 may be leant back 45 °.

Ensure that F1253 has not been damaged during transport.

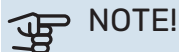

NOTE!

The product can be tail heavy.

Remove the outer panels in order to protect them when moving in confined spaces inside buildings.

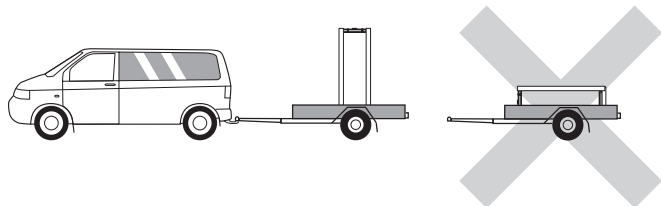

EXTRACTING THE COOLING MODULE

To simplify transport and service, the heat pump can be separated by pulling the cooling module out from the cabinet.

See page 54 for instructions about the separation.

Assembly

- Position F1253 on a solid foundation indoors that withstands water and the weight of the product.
- Use the product's adjustable feet to attain a horizontal and stable set-up.

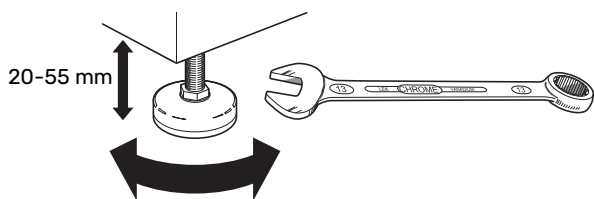

- Since water comes from F1253, the area where F1253 is located must be equipped with floor drainage.
- Install with its back to an outside wall, ideally in a room where noise does not matter, in order to eliminate noise problems. If this is not possible, avoid placing it against a wall behind a bedroom or other room where noise may be a problem.
- Wherever the unit is located, walls to sound sensitive rooms should be fitted with sound insulation.
- Route pipes so they are not fixed to an internal wall that backs on to a bedroom or living room.

INSTALLATION AREA

Leave a free space of 800 mm in front of the product. Approx. 50 mm free space is required on each side to allow the side panels to be removed. All service on F1253 can be carried out from the front, however the right-hand panel may need to be removed. Leave free space between the heat pump and the wall behind (and any routing of supply cables and pipes), to reduce the risk of any vibrations being propagated.

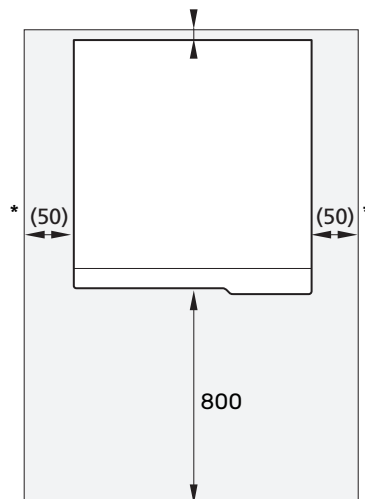

* A normal installation needs 300 – 400 mm (any side) for connection equipment, e.g. level vessel, valves and electrical equipment.

Supplied components



Outdoor temperature sensor (BT1)
1 x



Room sensor (BT50)
1 x

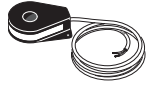

Current sensor^{1 2}
3 x



O-rings
8 x

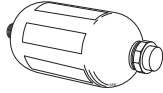

Level vessel (CM2)^{1 3}
1 x



Safety valve (FL3)
0.3 MPa (3 bar)¹
1 x



Filterball (QZ2)

4/6 KW

1 x G1
1 x G3/4



Compression ring couplings

4/6 KW

2 x (ø28 x G25)
2 x (ø22 x G20)

¹ Not Italy and the DACH countries.

² Not 1x230 V

³ Not Denmark

LOCATION

The kit of supplied items is placed in packaging on top of the heat pump.

Removing the covers

FRONT COVER

1. Remove the screws from the lower edge of the front panel.

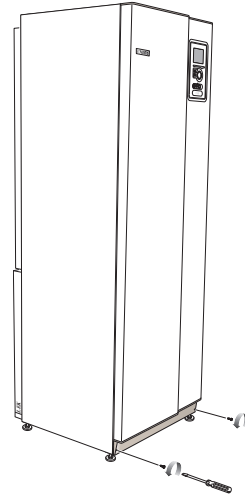

2. Lift the panel out at the bottom edge and up.
3. Pull the panel towards yourself.



SIDE COVERS

Side panels

1. Remove the screws from the upper and lower edges.

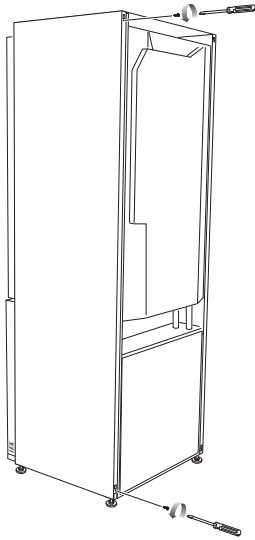

2. Twist the panel slightly outwards.

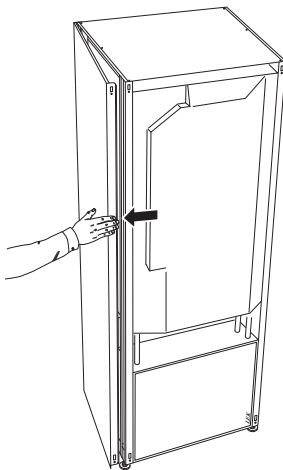

3. Move the panel outwards and backwards.

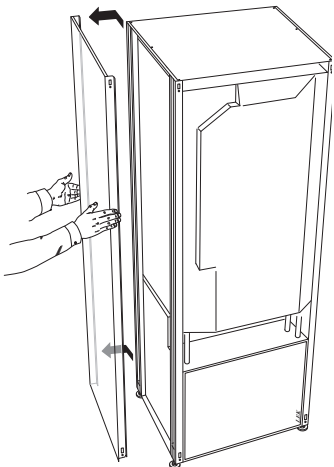

4. Assembly takes place in the reverse order.

Removing parts of the insulation

Parts of the insulation can be removed to facilitate the installation.

INSULATION, TOP

1. Disconnect the cable from the motor and remove the motor from the shuttle valve as illustrated.

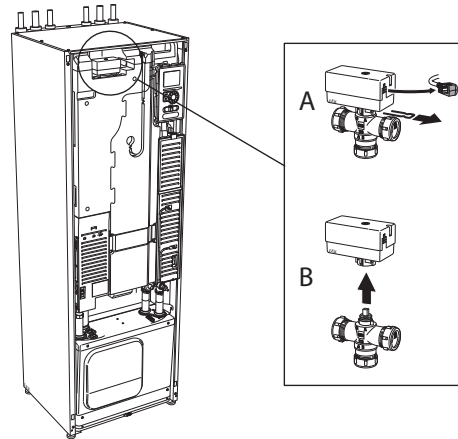

2. Grip the handle and pull straight out as illustrated.

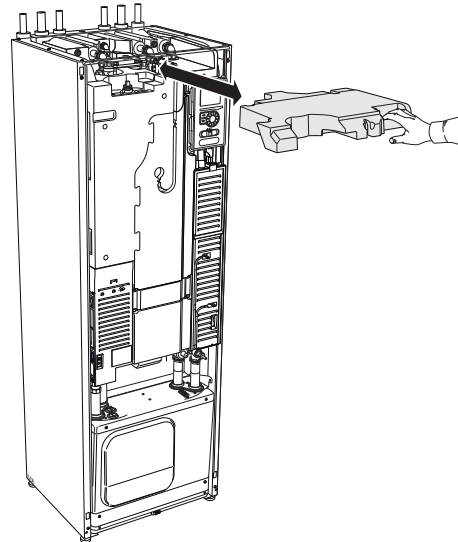

INSULATION, IMMERSION HEATER



CAUTION!

Electrical installation and service must be carried out under the supervision of a qualified electrician. Electrical installation and wiring must be carried out in accordance with the stipulations in force.

1. Remove the cover for the junction box according to the description on page 20.
2. Grip the handle and pull the insulation carefully towards you as illustrated.

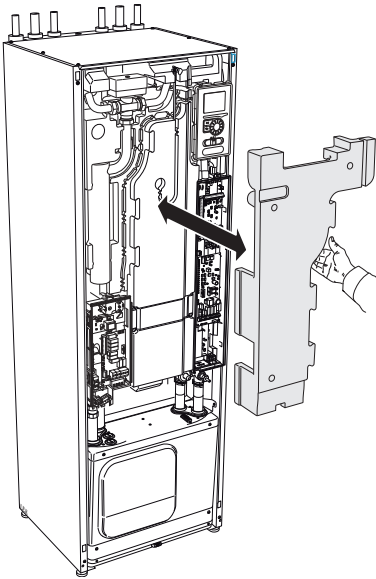

The heat pump design

General

VIEW FROM BEHIND

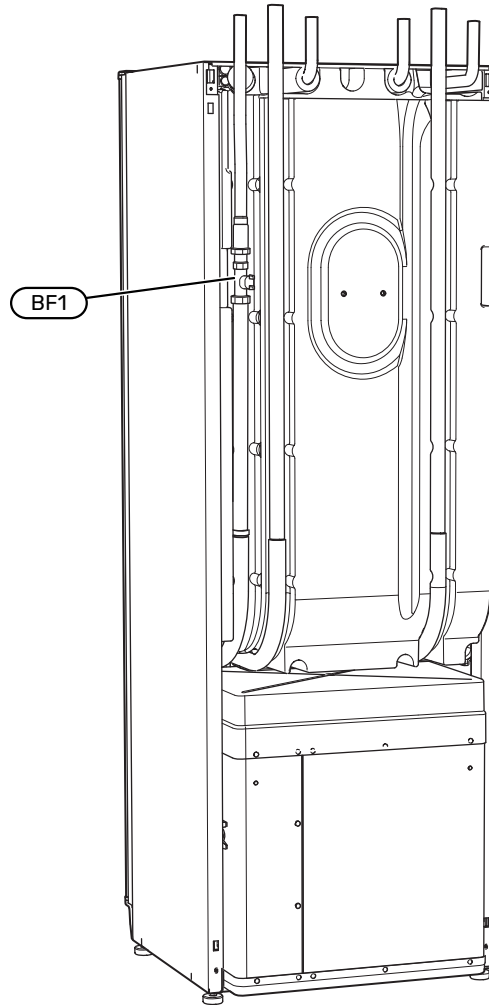
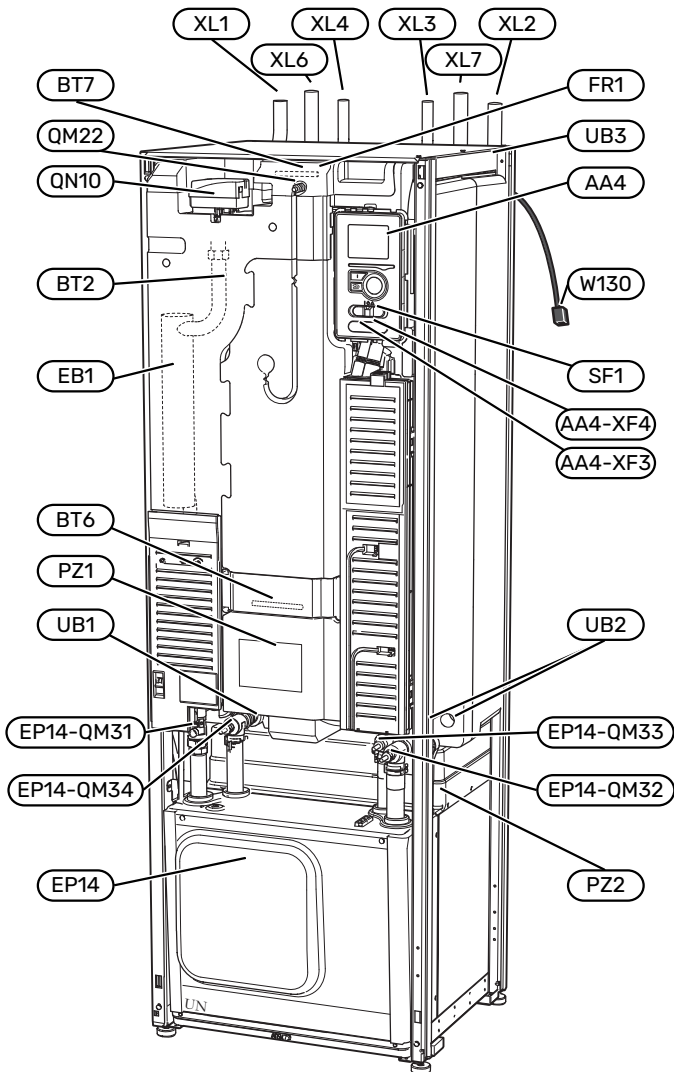

VIEW FROM ABOVE

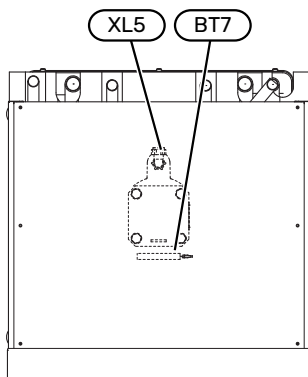

PIPE CONNECTIONS

XL1	Connection, heating medium flow
XL2	Connection, heating medium return
XL3	Connection, cold water
XL4	Connection, hot water
XL5	Connection, HWC*
XL6	Connection, brine in
XL7	Connection, brine out

* Only heat pumps with enamelled or stainless steel vessel.

HVAC COMPONENTS

EP14	Cooling module
	EP14-QM31 Shut-off valve, heating medium supply
	EP14-QM32 Shut off valve, heating medium return
	EP14-QM33 Shut off valve, brine out
	EP14-QM34 Shut-off valve, brine in
QM22	Venting, coil
QN10	Shuttle valve, climate system/water heater

SENSORS ETC.

BF1	Flow meter**
BT1	Outdoor temperature sensor*
BT2	Temperature sensors, heating medium flow
BT6	Temperature sensor, hot water charging
BT7	Temperature sensor, hot water top

**Only heat pumps with energy meter

* Not illustrated

ELECTRICAL COMPONENTS

AA4	Display unit
	AA4-XF3 USB socket
	AA4-XF4 Service outlet (No function)
EB1	Immersion heater
FR1	Electrical anode ¹
SF1	Switch
W130	Network cable for myUplink

¹ Only heat pump with enamelled vessel.

MISCELLANEOUS

EP14	Cooling module
PZ1	Rating plate
PZ2	Identification plate, cooling module
UB1	Cable gland, incoming electricity
UB2	Cable gland
UB3	Cable gland, rear side, sensor

Designations according to standard EN 81346-2.

Distribution boxes

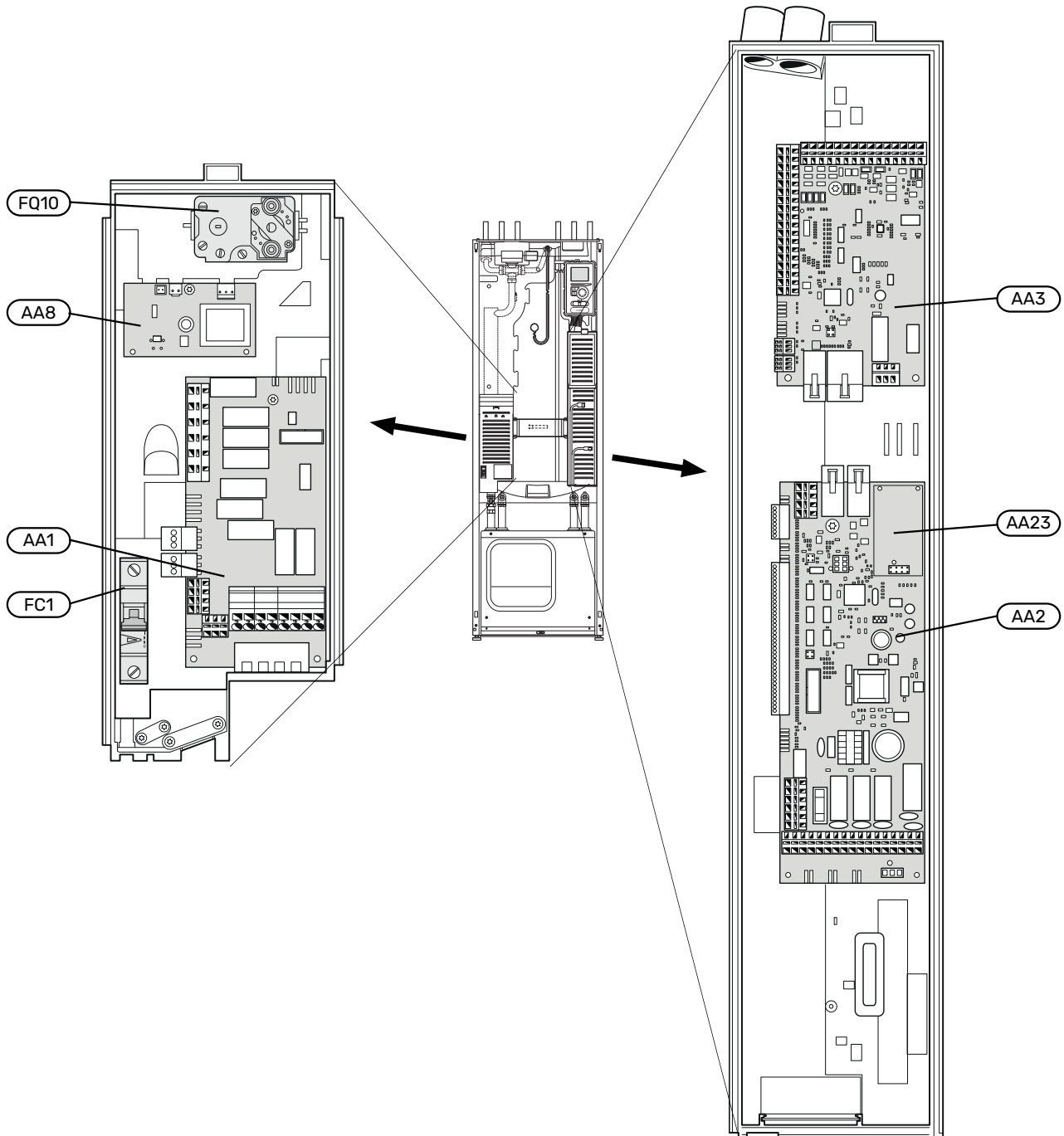

ELECTRICAL COMPONENTS

- AA1 Immersion heater card
- AA2 Base card
- AA3 Input circuit board
- AA8 Electrical anode board¹
- AA23 Communication board
- FC1 Miniature circuit-breaker
- FQ10 Temperature limiter/Emergency mode thermostat

¹ Only heat pump with enamelled vessel.

Cooling module (EP14)

4/6 kW

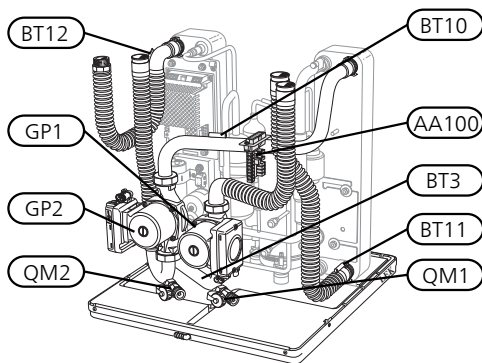

4/6 kW

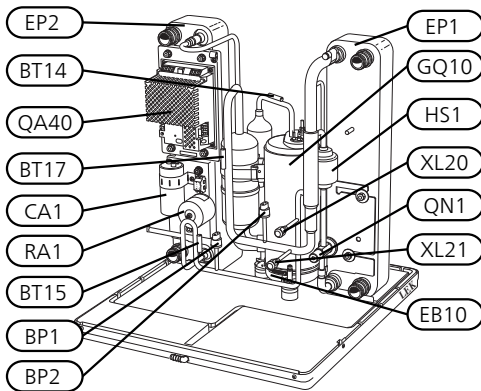

PIPE CONNECTIONS

- XL20 Service connection, high pressure
- XL21 Service connection, low pressure

HVAC COMPONENTS

- GP1 Circulation pump
- GP2 Brine pump
- QM1 Drainage, climate system
- QM2 Draining, brine side

SENSORS ETC.

- BP1 High pressure pressostat
- BP2 Low pressure pressostat
- BT3 Temperature sensors, heating medium return
- BT10 Temperature sensor, brine in
- BT11 Temperature sensor, brine out
- BT12 Temperature sensor, condenser supply line
- BT14 Temperature sensor, hot gas
- BT15 Temperature sensor, fluid pipe
- BT17 Temperature sensor, suction gas

ELECTRICAL COMPONENTS

- AA100 Joint card
- CA1 Capacitor
- EB10 Compressor heater
- QA40 Inverter
- RA1 Choke

COOLING COMPONENTS

- EP1 Evaporator
- EP2 Condenser
- GQ10 Compressor
- HS1 Drying filter
- QN1 Expansion valve

Pipe connections

General

Pipe installation must be carried out in accordance with current norms and directives. F1253 can operate with a return temperature of up to 58 °C and an outgoing temperature from the heat pump of 70 (65 °C with only the compressor).

NOTE!

Ensure that incoming water is clean. When using a private well, it may be necessary to supplement with an extra water filter.

NOTE!

Any high points in the climate system, must be equipped with air vents.



CAUTION!



















The pipe systems have to be flushed clean before the product is connected, to prevent any contaminants from damaging the components.



CAUTION!

Water may drip from the safety valve's overflow pipe. The overflow pipe must be routed to a suitable drain, to prevent hot water splashes from causing harm. The overflow pipe must be inclined along its entire length to prevent pockets where water can accumulate, and must be frost-proof. The overflow pipe must be at least the same size as the safety valve. The overflow pipe must be visible and its mouth must be open and not placed close to electrical components.

SYMBOL KEY

Symbol	Meaning
	Shut-off valve
	Non-return valve
	Mixing valve
	Circulation pump
	Expansion vessel
	Filterball
	Pressure gauge
	Level vessel
	Safety valve
	Reversing valve/shunt
	Heat exchanger
	Bore hole
	Ground collector
	Cooling system
	Pool
	Domestic hot water
	Heat pump
	Heating system
	Heating system with lower temperature

SYSTEM DIAGRAM

F1253 consists of a cooling module, a water heater, an immersion heater, circulation pumps and a control system.

F1253 is connected to the brine and heating medium circuits.

In the heat pump evaporator, the brine (water mixed with anti-freeze, glycol or ethanol) releases its energy to the refrigerant, which is vaporised in order to be compressed in the compressor. The refrigerant, of which the temperature has now been raised, is passed to the condenser where it gives off its energy to the heating medium circuit and, if necessary, to the water heater. If there is a greater need for heating/hot water than the compressor can provide there is an integrated immersion heater.

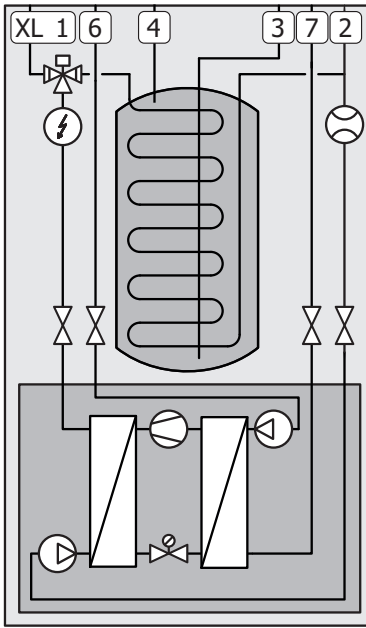

XL1	Connection, heating medium flow
XL2	Connection, heating medium return
XL3	Connection, cold water
XL4	Connection, hot water
XL6	Connection, brine in
XL7	Connection, brine out

Dimensions and pipe connections

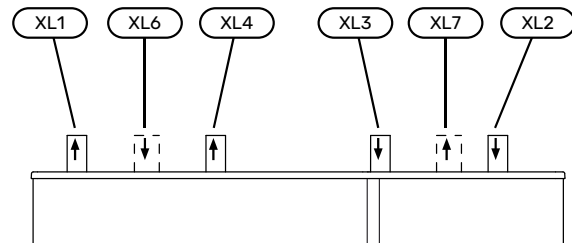
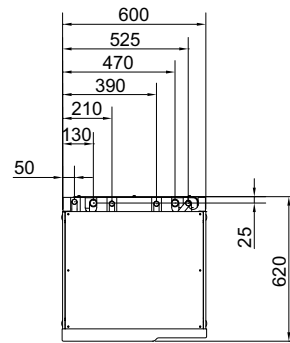
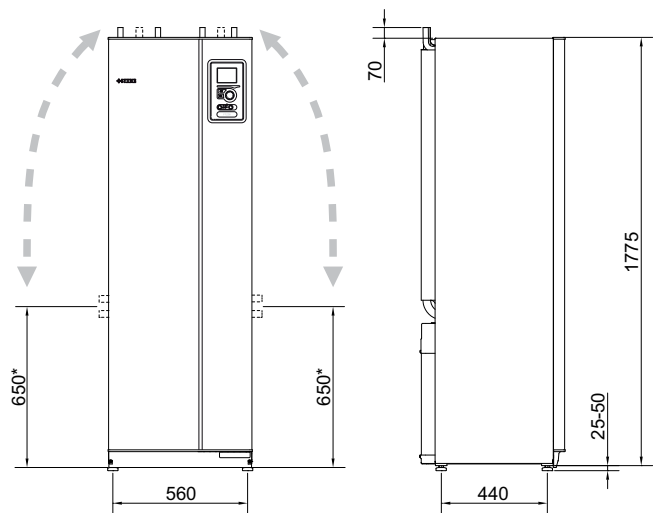

PIPE DIMENSIONS

Connection		4/6 kW
(XL6)/(XL7) Brine in/out ext. \emptyset	(mm)	28
(XL1)/(XL2) Heating medium flow/return ext. \emptyset	(mm)	22
(XL3)/(XL4) Cold/hot water \emptyset	(mm)	22

* Can be angled for side connection.

Brine side

COLLECTOR

NOTE!

The length of the collector hose varies depending on the rock/soil conditions, climate zone and on the climate system (radiators or underfloor heating) and the heating requirement of the building. Each installation must be sized individually.

In those cases where it is necessary to have several collectors, these should be connected in parallel with the possibility for adjusting the flow of the relevant coil.

For surface soil heat, the hose should be buried at a depth determined by local conditions and the distance between the hoses should be at least 1 metre.

For several bore holes, the distance between the holes must be determined according to local conditions.

Ensure the collector hose rises constantly towards the heat pump to avoid air pockets. If this is not possible, airvents should be used.

Because the temperature of the brine system can fall below 0 °C, it must be protected against freezing down to -15 °C. When making the volume calculation, use 1 litres of ready mixed brine per metre of collector hose (applies when using PEM-hose 40x2.4 PN 6.3) as a guide value.

SIDE CONNECTION

It is possible to angle the brine connections, for connection to the side instead of top connection.

To angle out a connection:

1. Disconnect the pipe at the top connection.
2. Angle the pipe in the desired direction.
3. If necessary, cut the pipe to the desired length.

CONNECTING THE BRINE SIDE

Insulate all indoor brine pipes against condensation.

Mark the brine system with the antifreeze that is used.

Install as follows:

- enclosed level vessel (CM2)/expansion vessel

The level vessel must be installed as the highest point in the brine system on the incoming pipe before the brine pump (Alternative 1). If the level vessel cannot be placed at the highest point, an expansion vessel must be used (Alternative 2).



CAUTION!

Note that condensation may drip from the level vessel. Position the vessel so that this does not harm other equipment.

- enclosed safety valve (FL3)

The safety valve is fitted below the level vessel.

- pressure gauge

The pressure gauge is only required if an expansion vessel is used.

- shut-off valve

Install the shut-off valve as close to F1253 as possible.

- enclosed filterball (QZ2)

Install the filterball as close to F1253 as possible.



TIP!

If filling connection KB25/KB32 is used, the enclosed filterball does not need to be fitted.

- vent valve

When necessary you should install venting valves in the brine system.

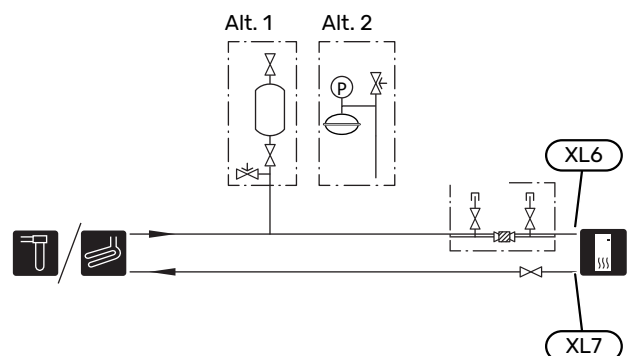

Climate system

A climate system is a system that regulates the indoor temperature with the help of the control system in F1253 and, for example, radiators, underfloor heating, underfloor cooling, fan coils, etc.

CONNECTING THE CLIMATE SYSTEM

Install as follows:

- expansion vessel
- pressure gauge
- pressure relief valve

Recommended opening pressure is 0.25 MPa (2.5 bar).

For information about max opening pressure, see technical specifications.

- enclosed filterball (QZ2)

Install the filterball as close to F1253 as possible.

- shut-off valve

Install the shut-off valve as close to F1253 as possible.

- When connecting to a system with thermostats, either a bypass valve must be fitted or, alternatively, some of the thermostats must be removed to ensure there is sufficient flow and heat emission.

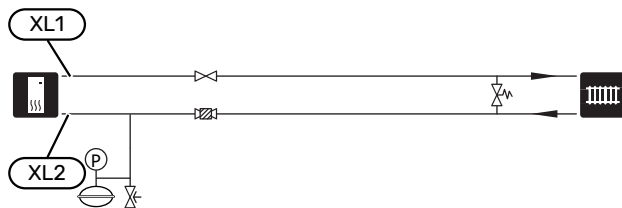

Cold and hot water

The settings for hot water are made in menu 5.1.1.

CONNECTING COLD AND HOT WATER

Install as follows:

- shut-off valve
- non-return valve
- pressure relief valve

The safety valve must have an opening pressure of max. 1.0 MPa (10.0 bar).

- mixing valve

A mixer valve must also be installed, if the factory setting for hot water is changed. National regulations must be observed.

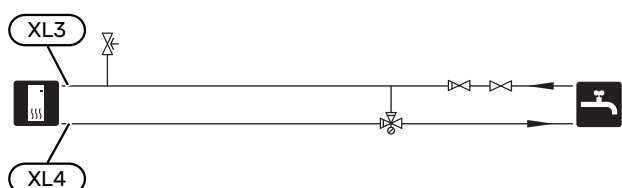

Installation alternative

F1253 can be installed in several different ways, some of which are shown here.

Further option information is available at nibe.eu and in the respective assembly instructions for the accessories used. See page 60 for a list of the accessories that can be used with F1253.

EXTRA HOT WATER HEATERS

The system should be supplemented with an extra water heater, if a large bath tub or other significant consumer of hot water is installed.

Water heater with immersion heater

In a water heater with an immersion heater, the water is initially heated by the heat pump. The immersion heater in the water heater is used for keeping warm and when the heat pump does not have sufficient power.

The water heater's flow is connected after F1253.

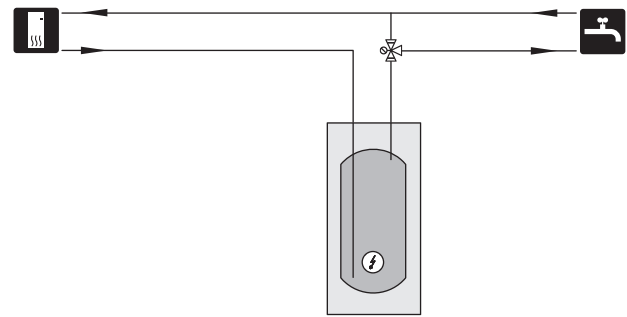

BUFFER VESSEL (UKV)

UKV is an accumulator tank that is suitable for connection to a heat pump or another external heat source, and can have several different applications.

For further information, see the Installer Manual for the accessory.

Volume

A 2-pipe-connected buffer vessel is used when the system volume in the climate system is less than the minimum recommended volume for the heat pump.

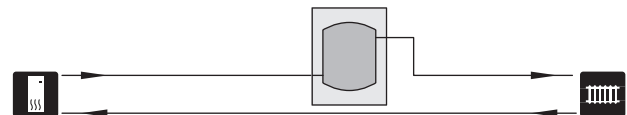

GROUND WATER SYSTEM

An intermediate heat exchanger is used to protect the heat pump's exchanger from dirt. The water is released into a buried infiltration unit or a drilled well. See page "Possible selections for AUX output" for more information about connecting a ground water pump.

If this docking alternative is used, "min. brine out" in menu 5.1.7 "br pmp al set." must be changed to a suitable value to prevent freezing of the heat exchanger.

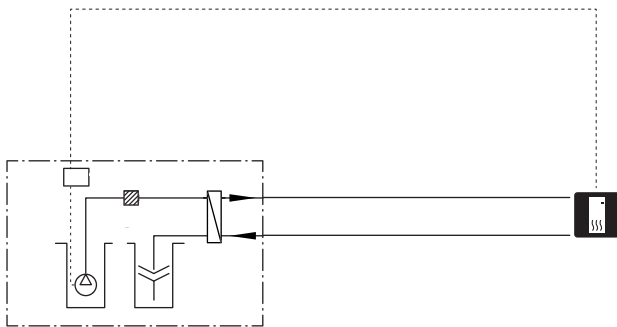

VENTILATION RECOVERY

The installation can be supplemented with the exhaust air module NIBE FLM to provide ventilation recovery.

- Pipes and other cold surfaces must be insulated with diffusion-proof material to prevent condensation.
- The brine system must be supplied with a pressure expansion vessel. If there is a level vessel this should be replaced.

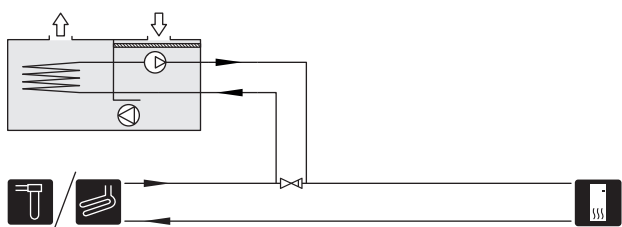

EXTRA CLIMATE SYSTEM

In buildings with several climate systems that require different supply temperatures, the accessory ECS 40/ECS 41 can be connected.

A shunt valve then lowers the temperature to the underfloor heating system, for example.

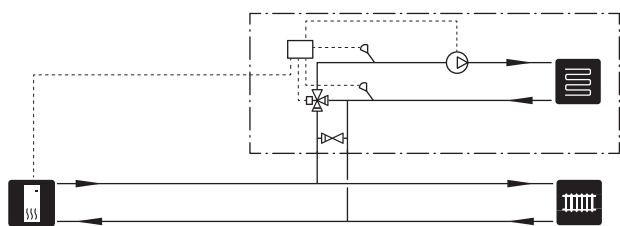

COOLING

The accessory PCS 44 allows the connection of passive cooling, for example with fan coils. The cooling system is connected to the heat pump brine circuit, whereby cooling is supplied from the collector via a circulation pump and shunt valve.

- Pipes and other cold surfaces must be insulated with diffusion-proof material to prevent condensation.
- Where the cooling demand is high, fan convectors with drip trays and drain connection are needed.
- The brine system must be supplied with a pressure expansion vessel. If there is a level vessel this should be replaced.

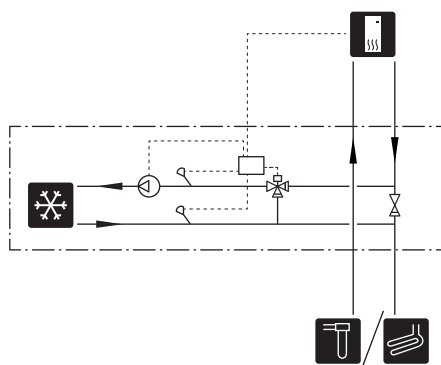

POOL

With the POOL 40 accessory, you can heat the pool with your system.

During pool heating, the heating medium circulates between the F1253 and the pool exchanger using the heat pump's internal circulation pump.

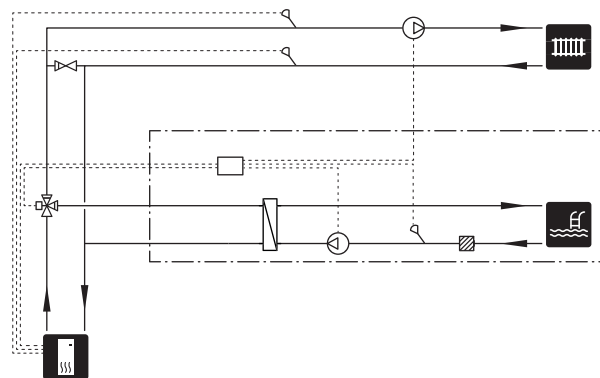

Electrical connections

General

All electrical equipment, except the outdoor sensors, room sensors and the current sensors are ready connected at the factory.

- Disconnect the heat pump before insulation testing the house wiring.
- If the building is equipped with an earth-fault breaker, F1253 should be equipped with a separate one.
- F1253 must be installed via an isolator switch. The cable area has to be dimensioned based on the fuse rating used.
- If a miniature circuit-breaker is used, this must have at least triggering characteristic "C". See page 64 for fuse size.
- Electrical wiring diagram for the heat pump, see page 74.
- Communication and sensor cables to external connections must not be laid close to high current cables.
- The minimum area of communication and sensor cables to external connections must be 0.5 mm² up to 50 m, for example EKKX or LiYY or equivalent.
- When cable routing in F1253, cable grommets (e.g. UB1-UB3, marked in image) must be used. In UB1-UB3 the cables are inserted through the heat pump from the back to the front.

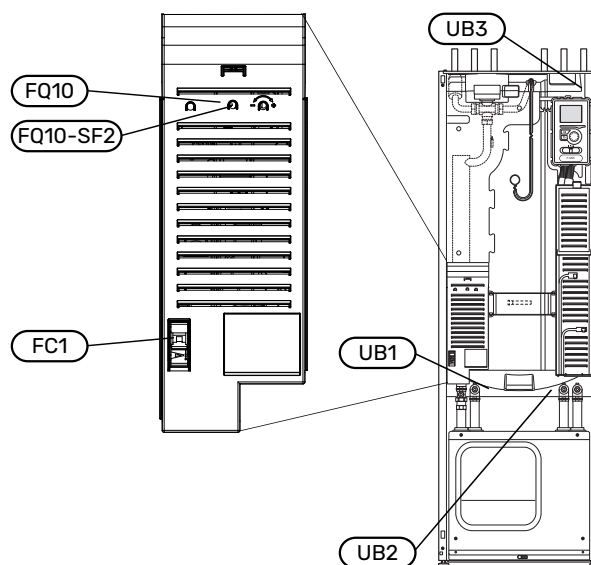

MINIATURE CIRCUIT-BREAKER

The heat pump's operating circuit and some of its internal components are internally fused by a miniature circuit breaker (FC1).

TEMPERATURE LIMITER

The temperature limiter (FQ10) cuts the power to the electric additional heat, if the temperature exceeds 89 °C and is reset manually.

Resetting

The temperature limiter (FQ10) is accessed behind the front cover. Reset the temperature limiter by pressing the button (FQ10-S2) using a small screwdriver.

ACCESSIBILITY, ELECTRICAL CONNECTION

The plastic cap of the electrical boxes is opened using a screwdriver.



CAUTION!

The switch (SF1) must not be set to "I" or "△" until the boiler has been filled with water. Components in the product could be damaged.



CAUTION!

Electrical installation and service must be carried out under the supervision of a qualified electrician. Cut the current with the circuit breaker before carrying out any servicing. Electrical installation and wiring must be carried out in accordance with the stipulations in force.



CAUTION!

Check the connections, main voltage and phase voltage before the product is started, to prevent damage to the heat pump electronics.



CAUTION!

The cover for the input card is opened without a tool.

Removing the cover, input circuit board

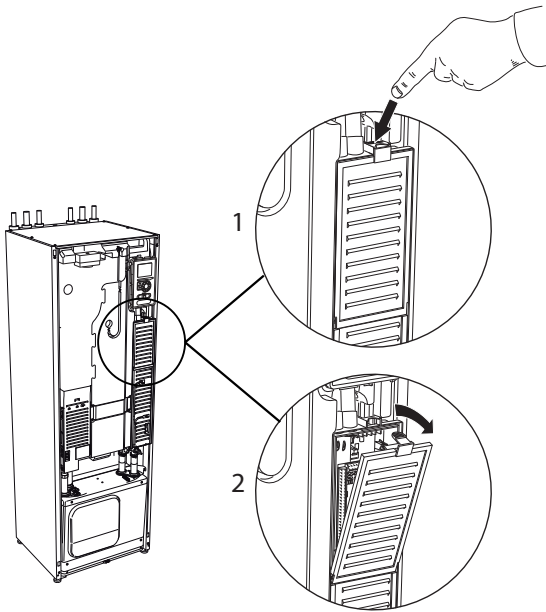

1. Push the catch down.
2. Angle out the cover and remove it.

Removing the cover, immersion heater circuit board

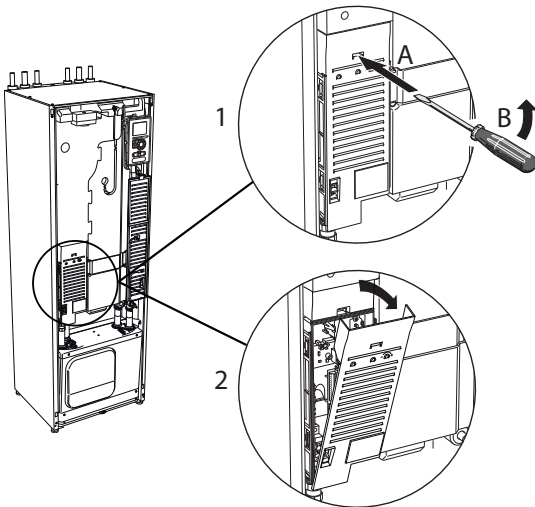

1. Insert the screwdriver (A) and pry the catch carefully downwards (B).
2. Angle out the cover and remove it.

Removing the cover, base board



NOTE!

To remove the cover for the base board, the cover for the input circuit board must first be removed.

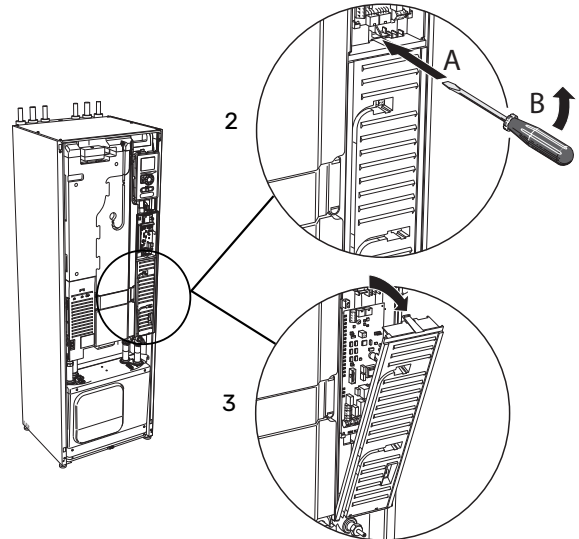
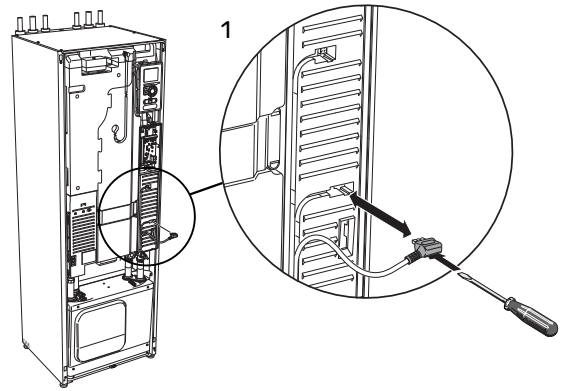

1. Disconnect the switches using a screwdriver.
2. Insert the screwdriver (A) and pry the catch carefully downwards (B).
3. Angle out the cover and remove it.

CABLE LOCK

Use a suitable tool to release/lock cables in the heat pump terminal blocks.

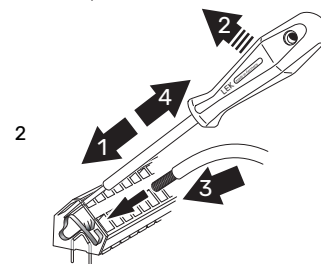
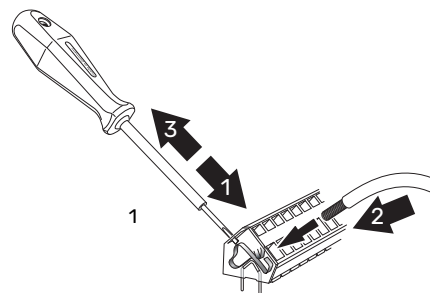

Connections



CAUTION!

To prevent interference, unscreened communication and/or sensor to external connections cables must not be laid closer than 20 cm to high voltage cable when cable routing.

POWER CONNECTION

F1253 must be installed with a disconnection option on the supply cable. Minimum cable area must be dimensioned based on the fuse used. Enclosed cable for incoming electricity supply is connected to terminal block X1 on the immersion heater board (AA1). All installations must be carried out in accordance with current norms and directives.

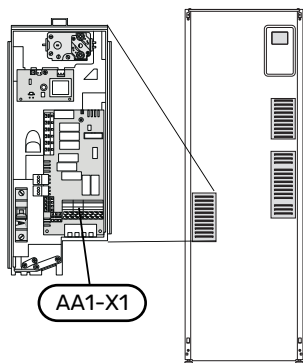

CAUTION!

F1253 cannot be switched between 1-phase and 3-phase.

Connection 3x400V

Connection 1x230V

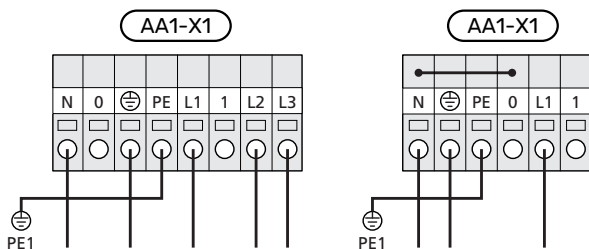

If a separate supply to the compressor and electric heater is wanted, see section "External blocking of functions" on page 27.

TARIFF CONTROL

If the voltage to the immersion heater and/or the compressor disappears during a certain period, there must also be blocking via the AUX-input, see "Connection options - Possible selection for AUX inputs" page. 27

CONNECTING EXTERNAL OPERATING VOLTAGE FOR THE CONTROL SYSTEM



CAUTION!

Only applies to power connection 3x400V.



CAUTION!

Mark up any junction boxes with warnings for external voltage.

If you wish to connect an external operating voltage for the control system to F1253 on the immersion heater board (AA1), the edge connector at AA1:X2 must be moved to AA1:X9 (as illustrated).

Control voltage (1x230V ~ 50Hz) is connected to AA1:X11 (as illustrated).

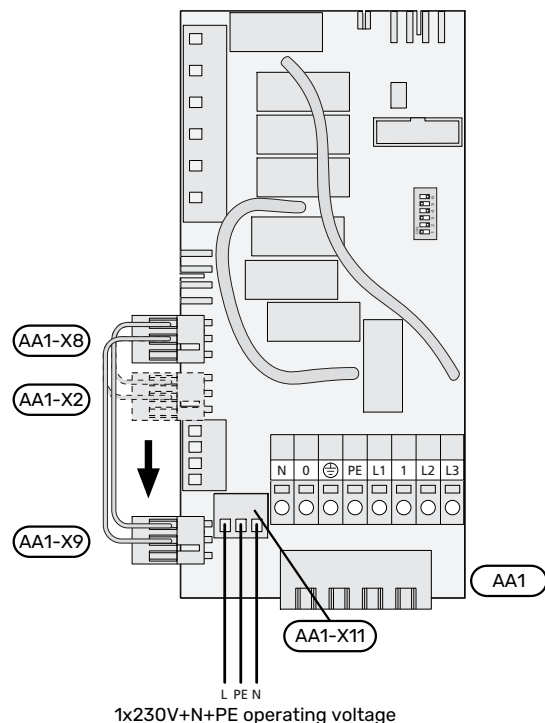

CONNECTING SENSORS

Connect the sensor(s) to terminal X6 on input board(AA3) according to the instructions below.

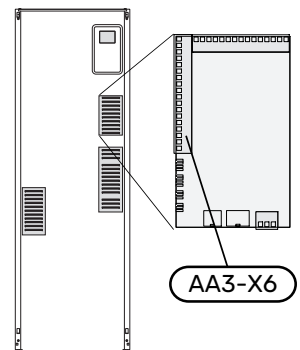

Outside sensor

The outdoor temperature sensor (BT1) is placed in the shade on a wall facing north or north-west, so it is unaffected, for example, by the morning sun.

Connect the outdoor temperature sensor to terminal block X6:1 and X6:2 on the input board (AA3).

If a conduit is used it must be sealed to prevent condensation in the sensor capsule.

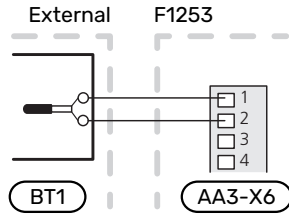

External supply temperature sensor

If an external supply temperature sensor (BT25) needs to be used, connect it to terminal block X6:5 and X6:6 on the input board (AA3).

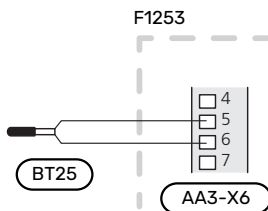

Room sensor

F1253 is supplied with an enclosed room sensor (BT50). The room sensor has a number of functions:

1. Shows current room temperature in the display on F1253.
2. Option of changing the room temperature in °C.
3. Provides the option of fine-tuning the room temperature.

Install the sensor in a neutral position where the set temperature is wanted.

A suitable location is on a free inner wall in a hall approx. 1.5 m above the floor. It is important that the sensor is not prevented from measuring the correct room temperature, for example by being located in a recess, between shelves, behind a curtain, above or close to a heat source, in a draught from an external door or in direct sunlight. Closed radiator thermostats can also cause problems.

F1253 operates without the room sensor, but if you want to read the home's indoor temperature from the display on F1253, the sensor must be fitted. Connect the room sensor to X6:3 and X6:4 on the input board (AA3).

If the room temperature sensor will have a controlling function, it is activated in menu 1.9.4 - "room sensor settings".

If the room sensor is used in a room with underfloor heating, it should only have an indicative function, not control of the room temperature.

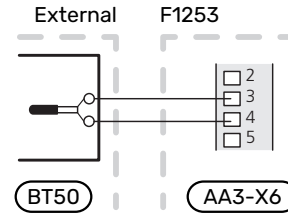

NOTE!

Changes of temperature in accommodation take time. For example, short time periods in combination with underfloor heating will not give a noticeable difference in room temperature.

Settings

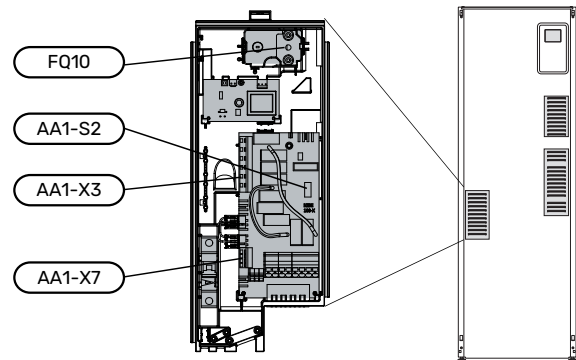

ELECTRICAL ADDITION - MAXIMUM OUTPUT

On delivery, the immersion heater is connected for a maximum of 7 kW (switchable to 9 kW at 3x400 V).

The immersion heater's output is split into seven steps (four steps if the immersion heater for 3x400 V is switched to maximum 9 kW), according to the table below.

F1253	Max	Number of connection steps
1x230 V	4.5 kW	9
3x400 V	6.5 kW	13

Setting max electrical output

Setting maximum output in the electric additional heat is done in menu 5.1.12.

The table displays the total phase current for the immersion heater at start up. If an immersion heater has already been started and is not used for its full capacity the values in the table can be changed because the control initially uses this immersion heater.

3x400 V, F1253 -4/6

Max electrical addition (kW)	Max phase current L1(A)	Max phase current L2(A)	Max phase current L3(A)
0.0	-	-	-
0.5	2.2	-	-
1.0	-	4.3	-
1.5	2.2	4.3	-
2.0	-	-	8.7
2.5	2.2	-	8.7
3.0	-	4.3	8.7
3.5	2.2	4.3	8.7
4.0	7.5	4.3	7.5
4.5	9.7	4.3	7.5
5.0	7.5	-	16.2
5.5	9.7	-	16.2
6.0	7.5	4.3	16.2
6.5	9.7	4.3	16.2

1x230 V, F1253 -4/6

Max electrical addition (kW)	Max phase current L1(A)
0.0	-
0.5	2.2
1.0	4.3
1.5	6.5
2.0	8.6
2.5	10.8
3.0	13.0
3.5	15.2
4.0	17.3
4.5	19.5

If the current sensors are connected, the heat pump monitors the phase currents and allocates the electrical steps automatically to the least loaded phase.

EMERGENCY MODE

When the heat pump is set to emergency mode ((SF1) is set to Δ), only the most essential functions are activated.

- The compressor is off and heating is managed by the immersion heater.
- Hot water is not produced.
- The load monitor is not connected.

CAUTION!

The switch (SF1) must not be set to "I" or Δ until F1253 has been filled with water. Components in the product can be damaged.

Power in emergency mode

The immersion heater's power in emergency mode is set with the DIP switch (S2) on the immersion heater board (AA1), according to the table below. The factory setting is 3,5 kW.

3x400V for F1253 -4/6

kW	1	2	3	4	5	6
0.5	on	off	off	off	off	off
1.0	off	off	on	off	off	off
1.5	on	off	on	off	off	off
2.0	off	off	off	off	on	off
2.5	on	off	off	off	on	off
3.0	off	off	on	off	on	off
3.5	on	off	on	off	on	off
4.0	off	on	on	off	off	on
4.5	on	on	on	off	off	on
5.0	off	on	off	off	on	on
5.5	on	on	off	off	on	on
6.0	off	on	on	off	on	on
6.5	on	on	on	off	on	on

1x230V for F1253-4/6

kW	1	2	3	4	5	6
0.5	on	off	off	off	off	off
1.0	off	off	on	off	off	off
1.5	on	off	on	off	off	off
2.0	off	off	off	off	on	on
2.5	on	off	off	off	on	off
3.0	off	off	on	off	on	off
3.5	on	off	on	off	on	off
4.0	off	off	on	off	on	on
4.5	on	off	on	off	on	on

3x400V/1x230V

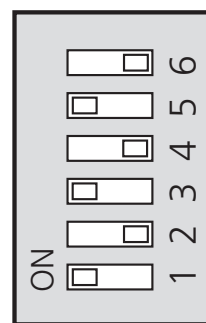

AA1-S2

The image shows the dip-switch (AA1-S2) in the factory setting.

Emergency mode thermostat

The supply temperature in emergency mode is set using a thermostat (FQ10). It can be set to 35 (pre-set, for example underfloor heating) or 45°C (for example radiators).

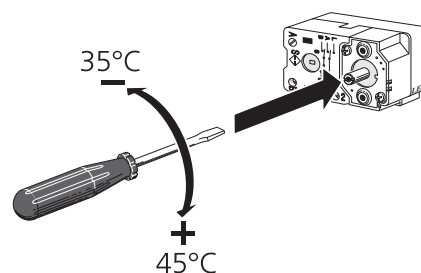

Optional connections

LOAD MONITOR

Integrated load monitor

F1253 is equipped with a simple form of integrated load monitor, which limits the power steps for the electric additional heat by calculating whether future power steps can be connected to the relevant phase without exceeding the current for the specified main fuse.

If the current would exceed the specified main fuse, the power step is not permitted. The size of the property's main fuse is specified in menu 5.1.12 - "internal electrical addition".

Load monitor with current sensor

When many power-consuming products are connected in the property at the same time as the compressor and/or the electric additional heat is operating, there is a risk of the property's main fuses tripping.

F1253 is equipped with a load monitor that, with the help of a current sensor, controls the power steps for the electric additional heat by redistributing the power between the different phases or, alternatively, disengages the electric additional heat step-by-step if there is an overload in a phase.

Reconnection occurs when the other current consumption is reduced.

Connection and activation of current sensors

1. Install a current sensor on each incoming phase conduct- or into the electrical distribution unit. This is best done in the electrical distribution unit.
2. Connect the current sensors to a multi-core cable in an enclosure directly adjacent to the electrical distribution unit. The multi-core cable between the enclosure and F1253 must have a cable area of at least 0.5 mm².

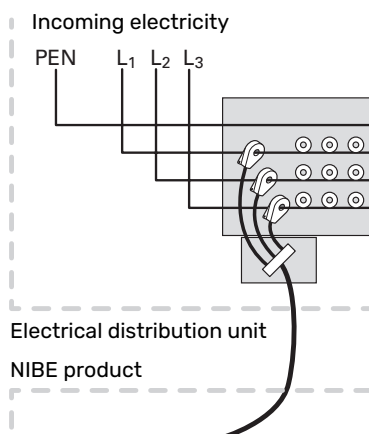

3. Connect the cable to the input board (AA3) on terminal block X4:1-4 where X4:1 is the common terminal block for the three current sensors.

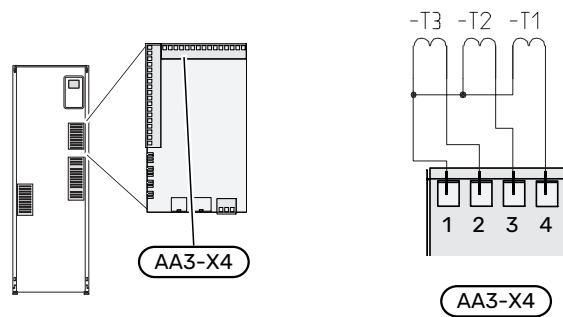

4. Specify the size of the property's main fuse in menu 5.1.12 - "internal electrical addition".
5. Activate phase detection in menu 5.1.12 - "internal electrical addition". Read more about phase detection in section "Menu 5.1.12 - internal electrical addition".

CONNECTING EXTERNAL ENERGY METER



CAUTION!

Connection of external energy meter requires version 35 or later on input board (AA3) as well as "display version" 7312 or later.

One or two energy meters (BE6, BE7) are connected to terminal block X22 and/or X23 on input board (AA3).

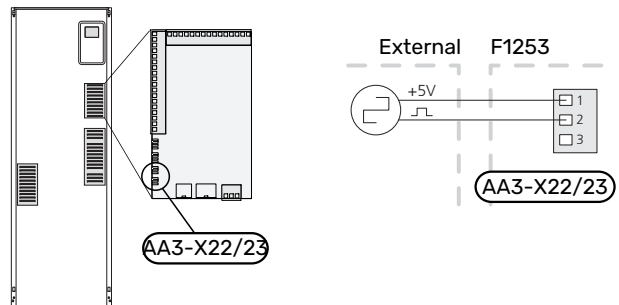

Activate the energy meter(s) in menu 5.2.4 and then set the desired value (energy per pulse) in menu 5.3.21.

MYUPLINK

Connect the network connected cable (straight, Cat.5e UTP) with RJ45-contact (male) to RJ45 contact (female) on the rear of the heat pump.

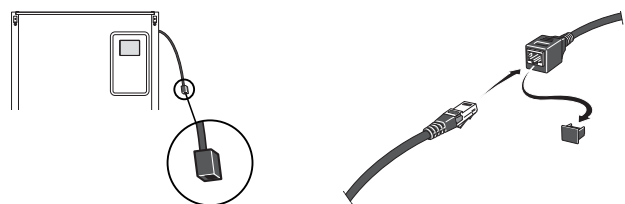

EXTERNAL CONNECTION OPTIONS

F1253 has software-controlled AUX inputs and outputs for connecting the external switch function (contact has to be potential-free) or sensor.

In menu 5.4 - "soft in/outputs", you select the AUX connection to which each function has been connected.

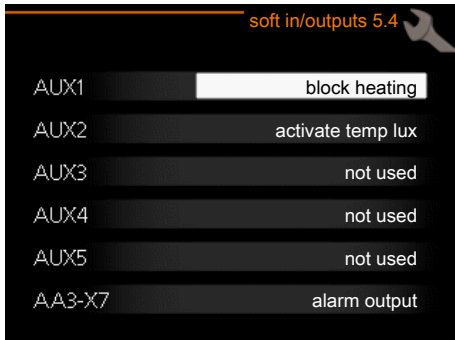

For certain functions, accessories may be required.



TIP!

Some of the following functions can also be activated and scheduled via menu settings.

Selectable inputs

Selectable inputs on the input board (AA3) for these functions are:

AUX1	AA3-X6:9-10
AUX2	AA3-X6:11-12
AUX3	AA3-X6:13-14
AUX4	AA3-X6:15-16
AUX5	AA3-X6:17-18

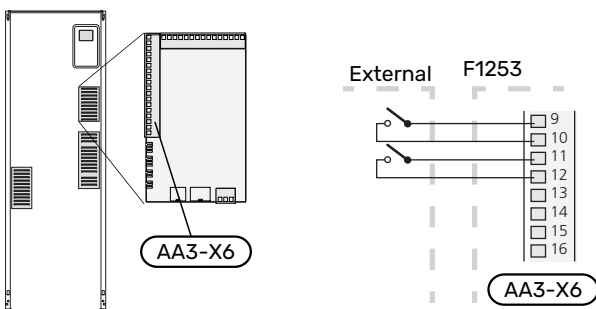

The example above uses the inputs AUX1 (X6:9-10) and AUX2 (X6:11-12) on the input board (AA3).

Selectable outputs

The output is a potential-free switching relay.

When switch (SF1) is in the "⏻" or "⚠" position, the relay is in the alarm position.

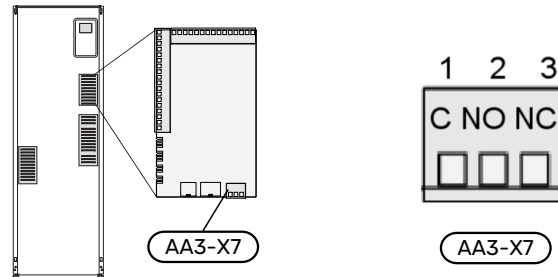

NOTE!

The relay output may be subjected to a max load of 2 A at resistive load (230 V-).



TIP!

The AXC accessory is required if more than one function is to be connected to the AUX output.

Possible selection for AUX inputs

Temperature sensor

Available options are:

- cooling/heating (BT74), determines when it is time to switch between cooling and heating mode (selectable when the cooling function is activated in menu 5.2.4 - "accessories").

Monitor

Available options are:

- alarm from external units.
The alarm is connected to the control, which means that the malfunction is shown as an information message in the display. Potential free signal of type NO or NC.
- level monitor¹ / pressure switch / flow monitor for brine (NC).
- pressure switch for climate system (NC).

External activation of functions

An external switch function can be connected to F1253 to activate various functions. The function is activated during the time the switch is closed.

Possible functions that can be activated:

- forced control of brine pump
- hot water comfort mode "temporary lux"
- hot water comfort mode "economy"
- "external adjustment"

¹ Accessory NV 10

When the switch is closed, the temperature is changed in °C (if a room sensor is connected and activated). If a room sensor is not connected or not activated, the desired change of "temperature" (heating curve offset) is set with the number of steps selected. The value is adjustable between -10 and +10. External adjustment of the climate system 2 to 8 is performed on the respective accessory boards.

- climate system 1 to 8

Setting the value for the change is performed in menu 1.9.2 - "external adjustment".

- activation of one of four fan speeds.

(Can be selected if ventilation accessory is activated.)

The following options are available:

- "activate fan speed 1 (NO)" - "activate fan speed 4 (NO)"
- "activate fan speed 1 (NC)"

The fan speed is activated during the time the switch is closed. Normal speed is resumed when the switch is opened again.

- +Adjust

Using +Adjust, the system communicates with the under floor heating's control centre² and adjusts the heating curve and calculated supply temperature based on the under floor heating system's feedback.

Activate the climate system you want +Adjust to affect by highlighting the function and pressing the OK button.



NOTE!

This function may require a software update in your F1253. The version can be checked in the menu 3.1 - "Service info". Visit myuplink.com and click on the "Software" tab to download the latest software to your installation.



NOTE!

In systems with both underfloor heating and radiators, NIBE ECS 40/41 should be used for optimum operation.

- SG ready



NOTE!

This function can only be used in mains networks that support the "SG Ready" standard.

"SG Ready" requires two AUX inputs.

"SG Ready" is a smart form of tariff control that allows your electricity supplier to affect the indoor, hot water and/or pool temperatures (if applicable) or simply block the additional heat and/or compressor in the heat pump

² Support for +Adjust is required

at certain times of the day (can be selected in menu 4.1.5 - "SG Ready" once the function is activated). Activate the function by connecting potential free switch functions to two inputs as selected in menu 5.4 - "soft in/outputs" (SG Ready A and SG Ready B).

Closed or open switch means one of the following:

- *Blocking (A: Closed, B: Open)*

"SG Ready" is active. The compressor in the heat pump and additional heat is blocked.

- *Normal mode (A: Open, B: Open)*

"SG Ready" is not active. No effect on the system.

- *Low price mode (A: Open, B: Closed)*

"SG Ready" is active. The system focuses on costs savings and can for example exploit a low tariff from the electricity supplier or over-capacity from any own power source (effect on the system can be adjusted in the menu 4.1.5).

- *Overcapacity mode (A: Closed, B: Closed)*

"SG Ready" is active. The system is permitted to run at full capacity at over capacity (very low price) with the electricity supplier (effect on the system is settable in menu 4.1.5).

(A = SG Ready A and B = SG Ready B)

External blocking of functions

An external switch function can be connected to F1253 for blocking various functions. The switch must be potential-free and a closed switch results in blocking.



CAUTION!

Blocking entails a risk of freezing.

Functions that can be blocked:

- heating (blocking of heating demand)
- hot water (hot water production). Any hot water circulation (HWC) remains in operation.
- compressor
- internally controlled additional heat
- tariff blocking (additional heat, compressor, heating, cooling and hot water are disconnected)

Possible selections for AUX output

Indications

- alarm
- common alarm
- cooling mode indication (only applies if there are cooling accessories)
- holiday

Control

- ground water pump
- circulation pump for hot water circulation
- external heating medium pump
- additional heat in charge circuit



CAUTION!

The relevant distribution box must be marked with a warning about external voltage.

An external circulation pump is connected to the AUX output, as illustrated below.

Connecting accessories

Instructions for connecting accessories are in the installation instructions provided for the respective accessory. See information at nibe.eu for the list of the accessories that can be used with F1253.

ACCESSORIES WITH CIRCUIT BOARD AA5

Accessories that contain circuit board AA5 are connected to the heat pump terminal block AA3-X4: 13-15. Use cable type LiYY, EKKX or similar.

If several accessories are to be connected, connect the first accessory card directly to the heat pump terminal block. Other accessory boards are connected to the first in series.

Because there can be different connections for accessories with circuit boards AA5, you should always read the instructions in the manual for the accessory that you are going to install.

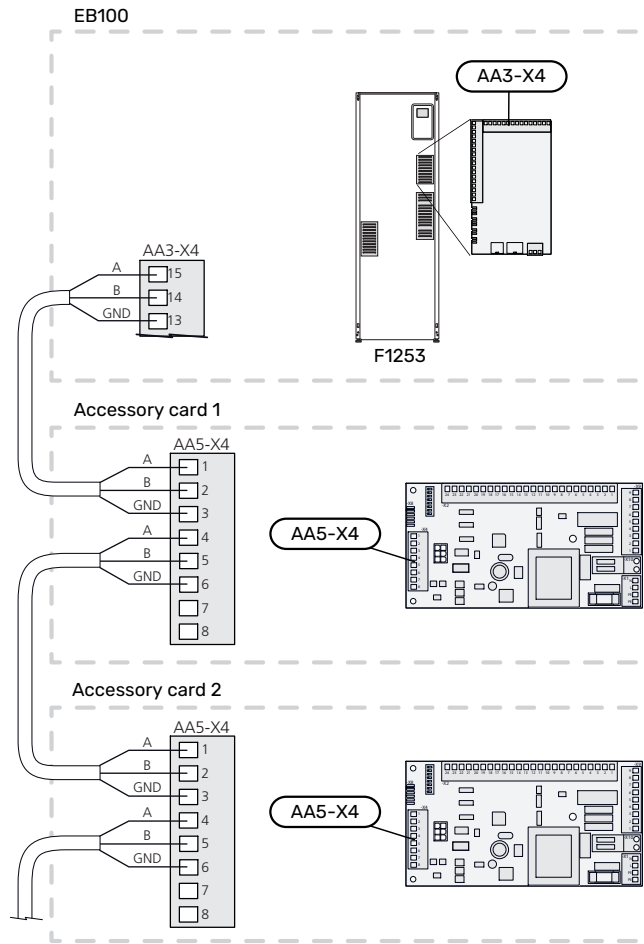

ACCESSORIES WITH CIRCUIT BOARD AA9

Accessories that contain the circuit board AA9 are connected to the heat pump's terminal block X4:9-12 on the input board AA3. Use cable type LiYY, EKKX or equivalent.

Because there can be different connections for accessories with circuit boards AA9, you should always read the instructions in the manual for the accessory that you are going to install.

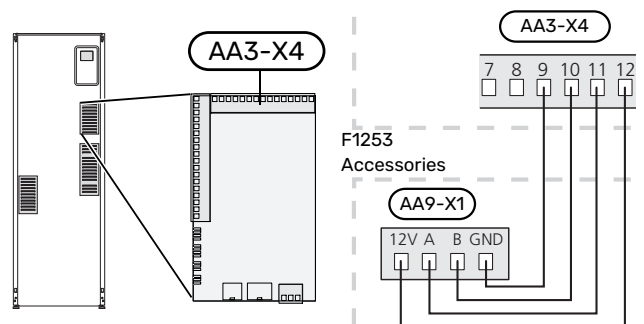

Commissioning and adjusting

Preparations

1. Check that the switch (SF1) is in position "⏻".
2. Check that the externally mounted filling valves are fully closed.

NOTE!

Check the miniature circuit-breaker (FC1). It could have tripped during transport.

Filling and venting

NOTE!

Insufficient venting can damage internal components in F1253.

FILLING THE CLIMATE SYSTEM

1. Open the externally mounted filling valve. Fill the coil in the hot water heater and the rest of the climate system with water.
2. Open the vent valve (QM22).
3. When the water that exits the vent valve (QM22) is not mixed with air, close the valve. After a while, the pressure starts to rise.
4. Close the filling valve when the correct pressure is obtained.

VENTING THE CLIMATE SYSTEM

1. Vent the heat pump via the vent valve (QM22) and the rest of the climate system via its respective vent valves.
2. Keep topping up and venting until all air has been removed and the pressure is correct.

CAUTION!

The pipe from the coil in the container must be drained of water before air can be removed. This means that the system is not necessarily vented, despite the flow of water when the vent valve (QM22) is opened.

FILLING THE HOT WATER HEATER

1. Open a hot water tap in the house.
2. Fill the hot water heater through the cold water connection (XL3).
3. When the water that comes out of the hot water tap is no longer mixed with air, the water heater is full and the tap can be closed.

FILLING THE BRINE SYSTEM

When filling the brine system, mix the water with antifreeze in an open container. The mixture should be protected against freezing down to about -15°C . The brine is topped up by connecting a filling pump.

1. Check the brine system for leakage.
2. Connect the filling pump and return line on the brine system's filling connection (accessory).
3. If alternative 1 is used (level vessel), close the valve under the level vessel.
4. Close the reversing valve in the filling connection.
5. Open the valves on the filler connector.
6. Start the filling pump.
7. Fill until liquid enters the return pipe.
8. Close the valves on the filler connector.
9. Open the reversing valve in the filling connection.
10. If alternative 1 (level vessel) is used, open the valve under the level vessel (CM2).

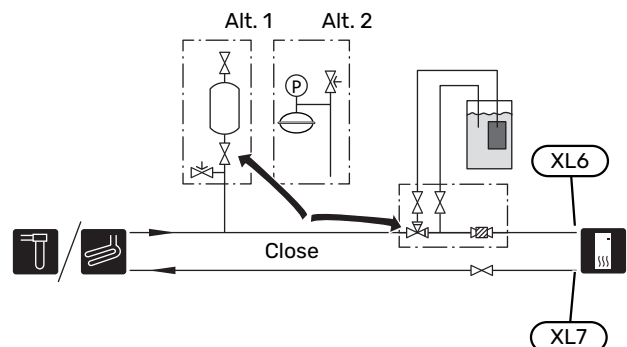

VENTING THE BRINE SYSTEM

Level vessel

Check the fluid level in the level vessel (CM2). If the fluid level has dropped, top up the system.

1. Close the valve under the vessel.
2. Disconnect the connection on top of the vessel.
3. Fill with brine until approx 2/3 of the vessel is full.
4. Reconnect the connector at the top of the vessel.
5. Open the valve under the vessel.

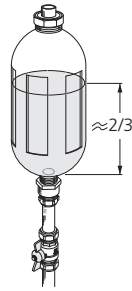

If the pressure in the system needs to be raised, this is done by closing the valve on the outgoing main line when the brine pump (GP2) is in operation and the level vessel (CM2) is open, so that liquid is drawn down from the vessel.

Expansion vessel

If a pressure expansion vessel (CM3) is used instead of a level vessel, the pressure level is checked with the pressure gauge (BP6). If the pressure drops, the system should be replenished.

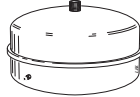

Start-up and inspection

START GUIDE



CAUTION!

There must be water in the climate system before the switch is set to "I".



CAUTION!

Do not start F1253 if there is a risk that the water in the system has frozen.

1. Set switch (SF1) on F1253 to position "I".
2. Follow the instructions in the display's start guide. If the start guide does not start when you start the F1253, you can start it manually in menu 5.7.

Follow the instructions in the start guide in the main unit's display. If the start guide does not start when you start the main unit, you can start it manually in menu 5.7.

If the building is cooled when F1253 starts, the compressor may not be able to meet the entire demand without having to use additional heating.

Commissioning

The first time the installation is started a start guide is started. The start guide instructions state what needs to be carried out at the first start together with a run through of the installation's basic settings.

The start guide ensures that the start-up is carried out correctly and, for this reason, cannot be skipped.



NOTE!

As long as the start guide is active, no function in the installation will start automatically.

The start guide will appear at each restart of the installation, until it is deselected on the last page.

Operation in the start guide

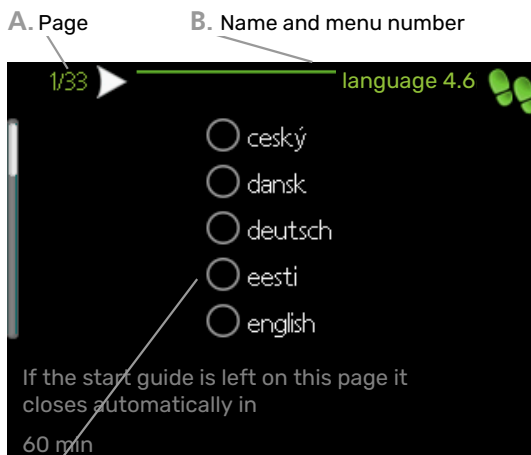

C. Option / setting

A. Page

Here you can see how far you have come in the start guide.

Scroll between the pages of the start guide as follows:

1. Turn the control knob until one of the arrows in the top left corner (at the page number) has been marked.
2. Press the OK button to skip between the pages in the start guide.

B. Name and menu number

Here, you can see which menu in the control system this page of the start guide is based on. The digits in brackets refer to the menu number in the control system.

If you want to read more about affected menus either consult the help menu or read the user manual.

C. Option / setting

Make settings for the system here.

SETTING PUMP SPEEDS

Pump adjustment, automatic operation

Brine side

To set the correct flow in the brine system, the brine pump must run at the correct speed. F1253 has a brine pump that is controlled automatically in standard mode. Certain functions and accessories may demand that it be run manually, in which case the correct speed must be set.

This automatic control occurs when the compressor is running and sets the speed of the brine pump so that the optimum temperature difference between the supply and return lines is attained.

Climate system

To set the correct flow in the climate system, the heating medium pump must run at the correct speed. F1253 has a heating medium pump that can be automatically controlled in standard mode. Certain functions and accessories may demand that it be run manually, in which case the correct speed must be set.

This automatic control takes place when the compressor is running and sets the speed of the heating medium pump, for the relevant operating mode, so the optimum temperature difference between the supply and return lines is obtained. During heating operation, the set DOT (dimensioned outdoor temperature) and temperature difference in menu 5.1.14 are used. If necessary, the maximum speed of the circulation pump can be limited in menu 5.1.11

Pump adjustment, manual operation

Brine side

F1253 has a brine pump that can be automatically controlled. For manual operation: deactivate "auto" in menu 5.1.9 and then set the speed according to the diagram below.



NOTE!

When an accessory for passive cooling is used, the brine pump speed must be set in menu 5.1.9.

Set the pump speed when the system has come into balance (ideally 5 minutes after compressor start).

Adjust the flow so the temperature difference between brine out (BT11) and brine in (BT10) is between 2 - 5 °C. Check these temperatures in menu 3.1 "service info" and adjust the brine pump's (GP2) speed until the temperature difference is obtained. A large difference indicates a low brine flow and a small difference indicates a high brine flow.

— External available pressure, kPa
— Electrical power, W

F1253-4/6 kW

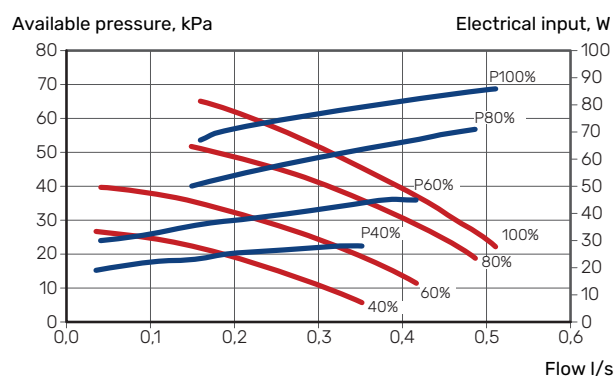

Climate system

F1253 has a heating medium pump that can be automatically controlled. For manual operation: deactivate "auto" in menu 5.1.11 and then set the speed according to the diagrams below.

The flow must have a temperature difference suitable for the operating case (heating operation: 5 - 10 °C, hot water generation: 5 - 10 °C, pool heating: approx. 15 °C) between controlling supply temperature sensor and return line sensor. Check these temperatures in menu 3.1 "service info" and adjust the heating medium pump's (GP1) speed until the

temperature difference is achieved. A large difference indicates a low heating medium flow and a small difference indicates a high heating medium flow.

— External available pressure, kPa
— Electrical power, W

F1253-4/6 kW

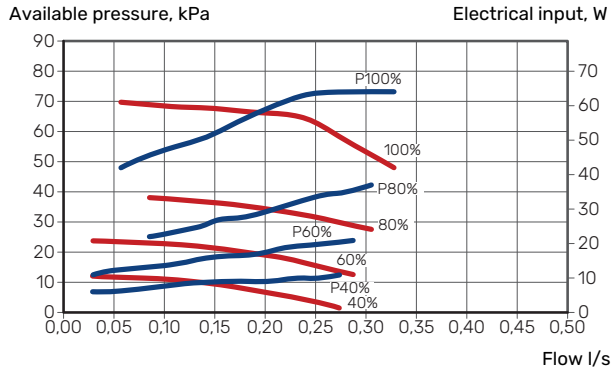

Setting the heating curve

In the menu "heating curve", you can see the heating curve for your house. The task of the curve is to provide an uniform indoor temperature, regardless of the outdoor temperature, and thereby energy-efficient operation. Based on this curve, the F1253 determines the temperature of the water to the climate system (the supply temperature) and thus the indoor temperature.

CURVE COEFFICIENT

The slope of the heating curve indicates how many degrees the supply temperature is to be increased/reduced when the outdoor temperature drops/increases. A steeper slope means a higher supply temperature at a certain outdoor temperature.

The lower the heating curve, the more energy efficient the operation, although an excessively low curve entails reduced comfort.

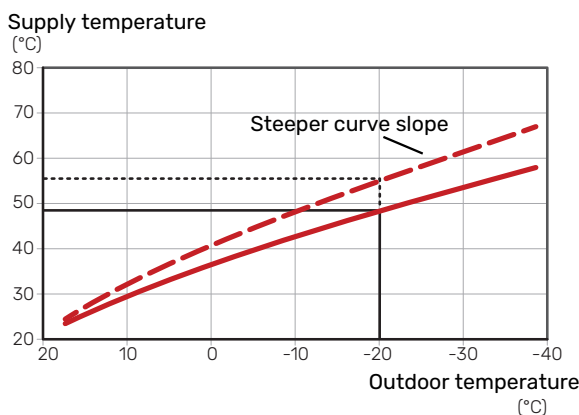

The optimum curve slope depends on the climate conditions and the lowest dimensioned outdoor temperature (DOT) in your location, whether the house has radiators, fan coils or underfloor heating and how well insulated the house is.

For houses with radiators or fan coils, a higher heating curve (e.g. curve 9) is suitable, for houses with under floor heating, a lower curve (e.g. curve 5) is suitable.

The heating curve is set when the heating installation is installed, but may need adjusting later. Normally, the curve will not need further adjustment.

CURVE OFFSET

An offset of the heating curve means that the supply temperature changes by the same amount for all outdoor temperatures, e.g. a curve offset of +2 steps increases the supply temperature by 5 °C at all outdoor temperatures.

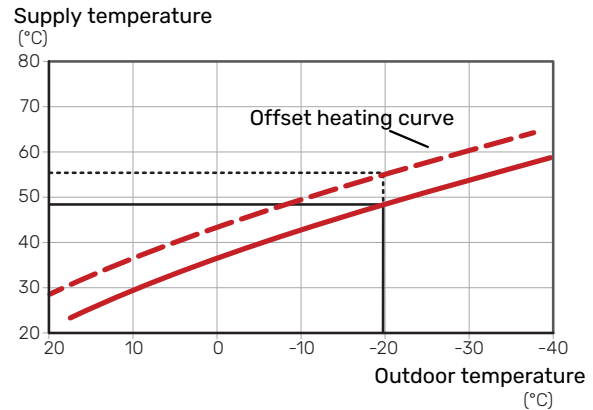

SUPPLY TEMPERATURE - MAXIMUM AND MINIMUM VALUES

Because the supply temperature cannot be calculated higher than the set maximum value or lower than the set minimum value, the curves flatten out at these temperatures.

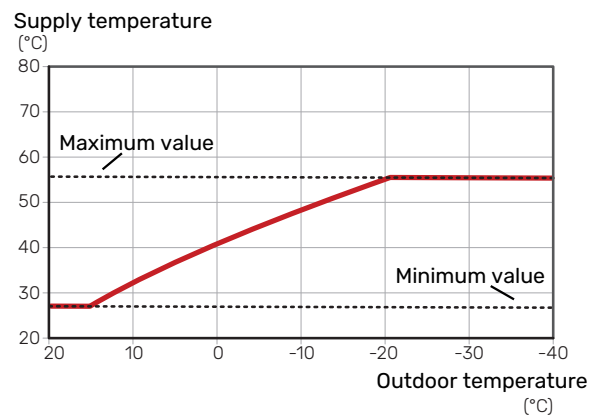

NOTE!

With underfloor heating systems, the maximum supply temperature is normally set between 35 and 45 °C.



NOTE!

With underfloor cooling, "Min. supply temp. cooling" must be restricted to prevent condensation.

ADJUSTMENT OF CURVE

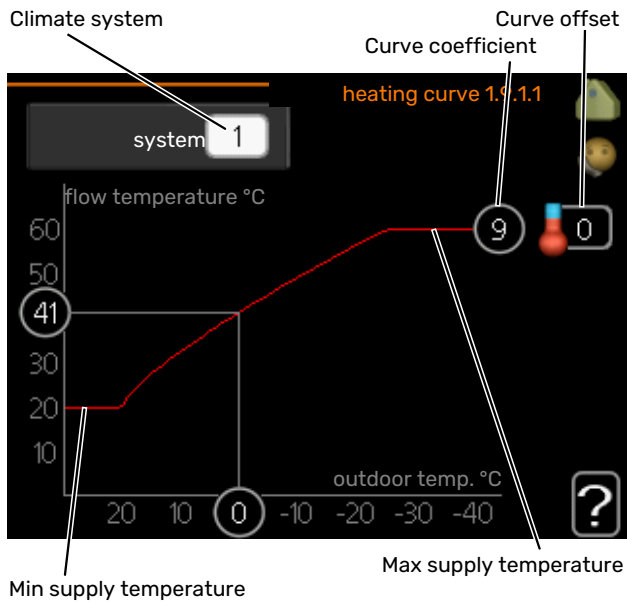

1. Select the climate system (if more than one) for which the curve is to be changed.
2. Select curve slope and curve offset.

NOTE!

If you need to adjust "min. flow line temp." and/or "max flow line temperature", you do this in other menus.

Settings for "min. flow line temp." in menu 1.9.3.

Settings for "max flow line temperature" in menu 5.1.2.

NOTE!

Curve 0 means that "own curve" is used.

Settings for "own curve" are made in menu 1.9.7.

TO READ OFF A HEATING CURVE

1. Turn the control knob so that the ring on the shaft with the outdoor temperature is marked.
2. Press the OK button.
3. Follow the grey line up to the curve and out to the left to read off the value for the supply temperature at the selected outdoor temperature.
4. You can now select to take read outs for different outdoor temperatures by turning the control knob to the right or left and read off the corresponding flow temperature.
5. Press the OK or Back button to exit read off mode.

myUplink

With myUplink you can control the installation – where and when you want. In the event of any malfunction, you receive an alarm directly to your e-mail or a push notification to the myUplink app, which allows you to take prompt action.

Visit myuplink.com for more information.

Update your system to the latest software version.

Specification

You need the following in order for myUplink to be able to communicate with your F1253:

- network cable
- Internet connection
- account on myuplink.com

We recommend our mobile apps for myUplink.

Connection

To connect your system to myUplink:

1. Select connection type (wifi/Ethernet) in menu 4.1.3 – internet.
2. Mark “request new connection string” and press the OK button.
3. When a connection string has been produced, it is shown in this menu and is valid for 60 minutes.
4. If you do not already have an account, register in the mobile app or on myuplink.com.
5. Use the connection string to connect your installation to your user account on myUplink.

Range of services

myUplink gives you access to various levels of service. The base level is included and, apart from this, you can choose two premium services for a fixed annual fee (the fee varies depending on the functions selected).

Service level	Basic	Premium extended history	Premium change settings
Viewer	X	X	X
Alarm	X	X	X
History	X	X	X
Extended history	-	X	-
Manage	-	-	X

myUplink PRO

myUplink PRO is a complete tool for offering service agreements to the end customer and for always having the latest information about the installation, as well as the option to adjust settings remotely.

With myUplink PRO, you can provide your connected customers with rapid status and remote diagnostics.

Visit pro.myuplink.com for information about what else you can do using the mobile app and online.

Control - Introduction

Display unit

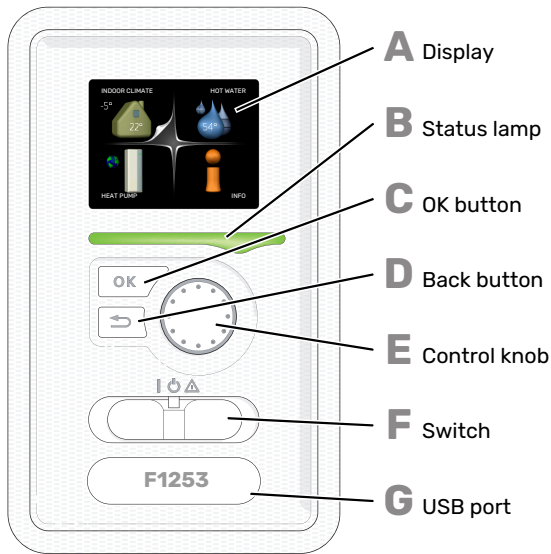

- A DISPLAY**
Instructions, settings and operational information are shown on the display. You can easily navigate between the different menus and options to set the comfort or obtain the information you require.
- B STATUS LAMP**
The status lamp indicates the status of the heat pump. It:
- lights green during normal operation.
 - lights yellow in emergency mode.
 - lights red in the event of a deployed alarm.
- C OK BUTTON**
The OK button is used to:
- confirm selections of sub menus/options/set values/page in the start guide.
- D BACK BUTTON**
The back button is used to:
- go back to the previous menu.
 - change a setting that has not been confirmed.
- E CONTROL KNOB**
The control knob can be turned to the right or left. You can:
- scroll in menus and between options.
 - increase and decrease the values.
 - change page in multiple page instructions (for example help text and service info).
- F SWITCH (SF1)**
The switch assumes three positions:
- On (I)
 - Standby (U)
 - Emergency mode (Δ)
- Emergency mode must only be used in the event of a fault on the heat pump. In this mode, the compressor switches off and the immersion heater engages. The heat pump display is not illuminated and the status lamp illuminates yellow.
- G USB PORT**
The USB port is hidden beneath the plastic badge with the product name on it.
The USB port is used to update the software.
Visit myuplink.com and click the "Software" tab to download the latest software for your installation.

Menu system



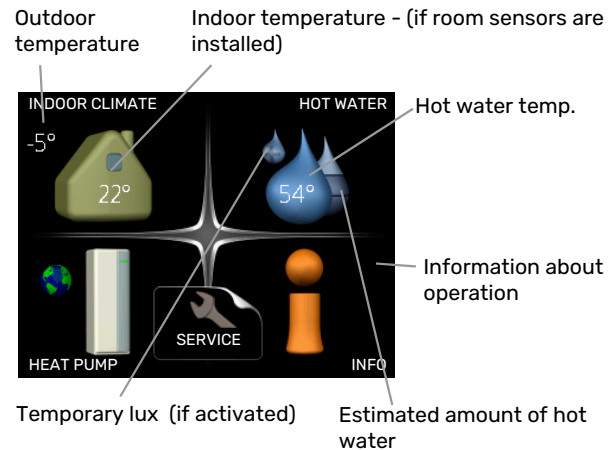







When the door to the heat pump is opened, the menu system's four main menus are shown in the display as well as certain basic information.



- MENU 1 - INDOOR CLIMATE**
Setting and scheduling the indoor climate. See information in the help menu or user manual.
- MENU 2 - HOT WATER**
Setting and scheduling hot water production. See information in the help menu or user manual.
- MENU 3 - INFO**
Display of temperature and other operating information and access to the alarm log. See information in the help menu or user manual.
- MENU 4 - HEAT PUMP**
Setting time, date, language, display, operating mode etc. See information in the help menu or user manual.
- MENU 5 - SERVICE**
Advanced settings. These settings are only intended for installers or service engineers. The menu is visible when the Back button is pressed for 7 seconds, when you are in the start menu. See page 41.

SYMBOLS IN THE DISPLAY

The following symbols may appear on the display during operation.

Symbol	Description
	This symbol appears by the information sign if there is information in menu 3.1 that you should note.
	<p>These two symbols indicate whether the compressor or addition is blocked in F1253.</p> <p>These can, for example, be blocked depending on which operating mode is selected in menu 4.2, if blocking is scheduled in menu 4.9.5 or if an alarm has occurred that blocks one of them.</p> <p> Blocking the compressor.</p> <p> Blocking additional heat.</p>
	This symbol appears if periodic increase or lux mode for the hot water is activated.
	This symbol indicates whether "holiday setting" is active in 4.7.
	This symbol indicates whether F1253 has contact with myUplink.
	This symbol indicates the actual speed of the fan if the speed has changed from the normal setting. Accessory needed.
	This symbol indicates whether pool heating is active. Accessory needed.
	This symbol indicates whether cooling is active. Accessory needed.

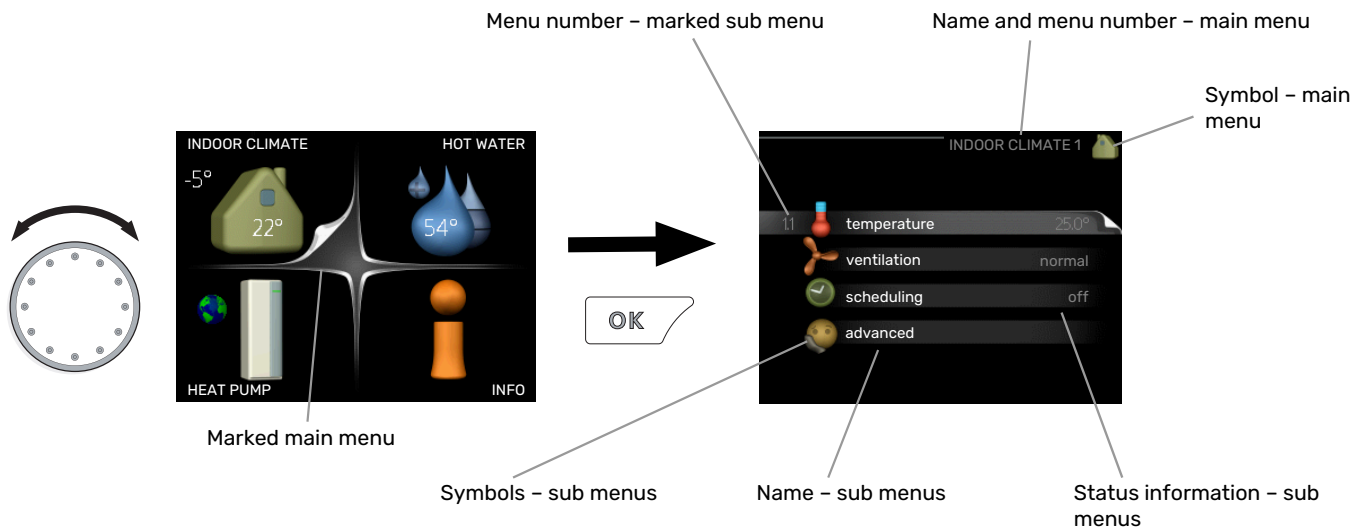

OPERATION

To move the cursor, turn the control knob to the left or the right. The marked position is white and/or has a turned up tab.

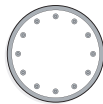

SELECTING MENU

To advance in the menu system select a main menu by marking it and then pressing the OK button. A new window then opens with sub menus.

Select one of the sub menus by marking it and then pressing the OK button.

SETTING A VALUE



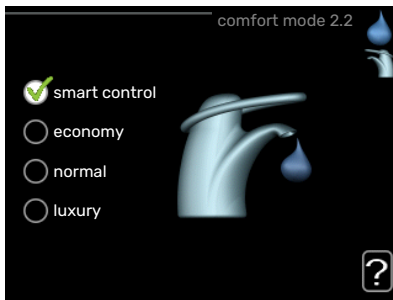

Values to be changed

SELECTING OPTIONS



In an options menu the current selected option is indicated by a green tick. 

To select another option:

1. Mark the applicable option. One of the options is pre-selected (white). 
2. Press the OK button to confirm the selected option. The selected option has a green tick. 

To set a value:

1. Mark the value you want to set using the control knob. 01
2. Press the OK button. The background of the value becomes green, which means that you have accessed the setting mode. 01
3. Turn the control knob to the right to increase the value and to the left to reduce the value. 04
4. Press the OK button to confirm the value you have set. To change and return to the original value, press the Back button. 04

USE THE VIRTUAL KEYBOARD

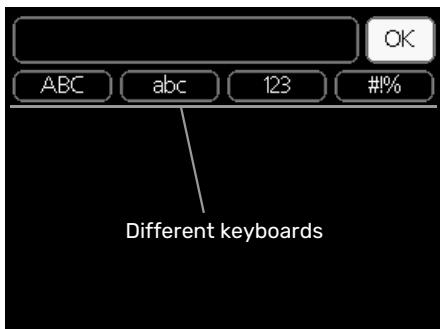

In some menus where text may require entering, a virtual keyboard is available.

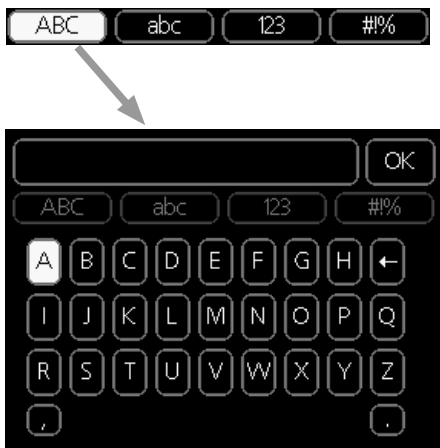

Depending on the menu, you can gain access to different character sets which you can select using the control knob. To change character table, press the Back button. If a menu only has one character set the keyboard is displayed directly. When you have finished writing, mark "OK" and press the OK button.

SCROLL THROUGH THE WINDOWS

A menu can consist of several windows. Turn the control knob to scroll between the windows.

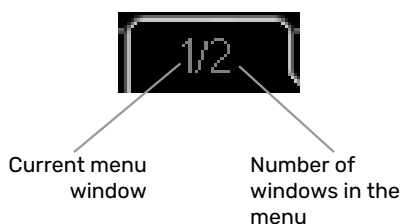

Scroll through the windows in the start guide



Arrows to scroll through window in start guide

1. Turn the control knob until one of the arrows in the top left corner (at the page number) has been marked.
2. Press the OK button to skip between the steps in the start guide.

HELP MENU

 In many menus there is a symbol that indicates that extra help is available.

To access the help text:

1. Use the control knob to select the help symbol.
2. Press the OK button.

The help text often consists of several windows that you can scroll between using the control knob.

Control - Menus

Menu 1 - INDOOR CLIMATE

1 - INDOOR CLIMATE	1.1 - temperature	1.1.1 - heating	
		1.1.2 - cooling *	
	1.2 - ventilation *		
	1.3 - scheduling	1.3.1 - heating	
		1.3.2 - cooling *	
		1.3.3 - ventilation *	
	1.9 - advanced	1.9.1 - curve	1.9.1.1 heating curve
			1.9.1.2 - cooling curve *
		1.9.2 - external adjustment	
		1.9.3 - min. flow line temp.	1.9.3.1 - heating
			1.9.3.2 - cooling *
		1.9.4 - room sensor settings	
		1.9.5 - cooling settings *	
1.9.6 - fan return time *			
1.9.7 - own curve		1.9.7.1 - heating	
		1.9.7.2 - cooling *	
1.9.8 - point offset			
1.9.9 - night cooling			
1.9.11 - +Adjust			
1.9.12 - FLM cooling*			

Menu 2 - HOT WATER

2 - HOT WATER	2.1 - temporary lux	
	2.2 - comfort mode	
	2.3 - scheduling	
	2.9 - advanced	2.9.1 - periodic increase
		2.9.2 - hot water recirc.

Menu 3 - INFO

3 - INFO	3.1 - service info
	3.2 - compressor info
	3.3 - add. heat info
	3.4 - alarm log
	3.5 - indoor temp. log
	3.6 - energy log

* Accessories are needed.

Menu 4 - HEAT PUMP

4 - HEAT PUMP	4.1 - plus functions	4.1.1 - pool *	
		4.1.3 - internet	4.1.3.1 - myUplink
			4.1.3.8 - tcp/ip settings
			4.1.3.9 - proxy settings
	4.1.5 - SG Ready		

	4.1.6 - smart price adaption™
	4.1.7 - smart home
	4.1.8 - smart energy source™
	4.1.8.1 - settings
	4.1.8.2 - set. price
	4.1.8.3 - CO2 impact
	4.1.8.4 - tariff periods, electricity
	4.1.8.5 - tariff periods, fixed price
	4.1.8.6 - tariff per, ext. shunt add
	4.1.8.7 - tariff per, ext. step add
	4.1.8.8 - tariff periods, OPT10
	Menu 4.1.10 - solar electricity *
4.2 - op. mode	
4.4 - time & date	
4.6 - language	
4.7 - holiday setting	
4.9 - advanced	4.9.1 - op. prioritisation
	4.9.2 - auto mode setting
	4.9.3 - degree minute setting
	4.9.4 - factory setting user
	4.9.5 - schedule blocking

* Accessory needed.

Menu 5 - SERVICE

OVERVIEW

5 - SERVICE	5.1 - operating settings	5.1.1 - hot water settings
		5.1.2 - max flow line temperature
		5.1.3 - max diff flow line temp.
		5.1.4 - alarm actions
		5.1.5 - fan sp. exhaust air *
		5.1.7 - br pmp al set.
		5.1.8 - operating mode brine pump
		5.1.9 - brine pump speed
		5.1.10 - op. mod heat med pump
		5.1.11 - pump speed heating medium
		5.1.12 - internal electrical addition
		5.1.14 - flow set. climate system
		5.1.22 - heat pump testing
		5.1.24 - blockFreq
	5.2 - system settings	5.2.4 - accessories
	5.3 - accessory settings	5.3.1 - FLM *
		5.3.2 - shunt controlled add. heat *
		5.3.3 - extra climate system *
		5.3.4 - solar heating *
		5.3.6 - step controlled add. heat
		5.3.8 - hot water comfort *
		5.3.11 - modbus *
		5.3.12 - exhaust/supply air module *
		5.3.16 - humidity sensor *
		5.3.21 - flow sensor / energy meter*
	5.4 - soft in/outputs	
	5.5 - factory setting service	
	5.6 - forced control	
	5.7 - start guide	
	5.8 - quick start	
	5.9 - floor drying function	
	5.10 - change log	

* Accessory needed.

Go to the main menu and hold the Back button in for 7 seconds to access the Service menu.

Sub-menus

Menu **SERVICE** has orange text and is intended for the advanced user. This menu has several sub-menus. Status information for the relevant menu can be found on the display to the right of the menus.

operating settings Operating settings for the heat pump.

system settings System settings for the heat pump, activating accessories etc.

accessory settings Operational settings for different accessories.

soft in/outputs Setting software-controlled inputs and outputs on input board (AA3).

factory setting service Total reset of all settings (including settings available to the user) to default values.

forced control Forced control of the different components in the heat pump.

start guide Manual start of the start guide which is run the first time the heat pump is started.

quick start Quick starting the compressor.



CAUTION!

Incorrect settings in the service menus can damage the heat pump.

MENU 5.1 - OPERATING SETTINGS

Operating settings can be made for the heat pump in the sub menu.

MENU 5.1.1 - HOT WATER SETTINGS



CAUTION!

The factory set tap water temperatures specified in the manual can vary due to the directives in force in different countries. From this menu, you can check the relevant settings for the system.

start temp. economy / normal / lux

Setting range: 5 – 70 °C

Factory setting (°C):

economy	normal	luxury
40	44	47

stop temp. economy / normal / lux

Setting range: 5 – 70 °C

Factory setting (°C):

economy	normal	luxury
44	48	51

stop temp. per. increase

Setting range: 55 – 70 °C

Factory setting: 55 °C

high power

Setting range: on/off

Factory setting: off

Here you set the start and stop temperature of the hot water for the different comfort options in menu 2.2 as well as the stop temperature for periodic increase in menu 2.9.1.

For a higher charge output click the high output selection.

With “high power” activated, the hot water is charged with greater power than standard mode and therefore has a faster recharging time.

MENU 5.1.2 - MAX FLOW LINE TEMPERATURE

climate system

Setting range: 20-80 °C

Default value: 60 °C

Here, you set the maximum supply temperature for the climate system. If the installation has more than one climate system, individual maximum supply temperatures can be set for each system. Climate system 2 - 8 cannot be set to a higher max supply temperature than climate system 1.



NOTE!

For underfloor heating systems, max flow line temperature should normally be set to between 35 and 45°C.

Check the max floor temperature with your floor supplier.

MENU 5.1.3 - MAX DIFF FLOW LINE TEMP.

max diff compressor

Setting range: 1 – 25 °C

Default value: 10 °C

max diff addition

Setting range: 1 – 24 °C

Default value: 7 °C

Here you set the maximum permitted difference between the calculated and actual supply temperature in the event of compressor or additional heat mode respectively. Max diff. additional heat can never exceed max diff. compressor

max diff compressor

If the current supply temperature *exceeds* the calculated supply by set value, the degree minute value is set to +2. The compressor in the heat pump stops if there is only a heating demand.

max diff addition

If “addition” is selected and activated in menu 4.2 and the current supply temperature *exceeds* the calculated temperature by the set value, the additional heat is forced to stop.

MENU 5.1.4 - ALARM ACTIONS

Select how you want the heat pump to alert you that there is an alarm in the display here.

The different alternatives are that the heat pump stops producing hot water (default setting) and/or reduces the room temperature.



NOTE!

If no alarm action is selected, it can result in higher energy consumption in the event of an alarm.

MENU 5.1.5 - FAN SP. EXHAUST AIR (ACCESSORY IS REQUIRED)

normal and speed 1-4

Setting range: 0 – 100 %

Set the speed for the five different selectable speeds for the fan here.



NOTE!

An incorrectly set ventilation flow can damage the house and may also increase energy consumption.

MENU 5.1.7 - BR PMP AL SET.

min. brine out

Setting range: -12 – 15 °C

Default value: -8 °C

min. brine out

Set the temperature at which the heat pump is to activate the alarm for low temperature in outgoing brine.

If "automatic reset" is selected, the alarm resets when the temperature has increased by 1 °C below the set value.

MENU 5.1.8 - OPERATING MODE BRINE PUMP

op. mode

Setting range: intermittent, continuous, 10 days continuous

Default value: intermittent

Set the operating mode of the brine pump here.

intermittent: The brine pump starts approx. 20 seconds before and stops approx. 20 seconds after the compressor.

continuous: Continuous operation.

10 days continuous: Continuous operation for 10 days. The pump then shifts to intermittent operation.



TIP!

You can use "10 days continuous" at start-up to obtain continuous circulation during a start-up time in order to make it easier to bleed the system.

MENU 5.1.9 - BRINE PUMP SPEED

op. mode

Setting range: auto / manual / fixed delta

Default value: auto

delta-T, fixed delta

Setting range: 2 - 10 °C

Factory setting: 4 °C

speed in wait mode

Setting range: 1 - 100 %

Factory setting: 70 %

Speed extern. contr. (AUX)

Setting range: 1 - 100 %

Factory setting: 100 %

manual

Setting range: 1 - 100 %

Factory setting: 100 %

speed passive cooling (accessory is required)

Setting range: 1 - 100 %

Factory setting: 75 %

speed active cooling (accessory is required)

Setting range: 1 - 100 %

Factory setting: 75 %

speed in wait mode cooling (accessory is required)

Setting range: 1 - 100 %

Factory setting: 30 %

temperature difference, active cooling (accessory required)

Setting range: 2 - 10 °C

Factory setting: 5 °C

Set the speed of the brine pump here. Select "auto" if the speed of the brine pump is to be regulated automatically (factory setting) for optimal operation.

For manual operation of the brine pump, deactivate "auto" and set the value to between 1 and 100 %.

For operation of brine pump with "fixed delta", select "fixed delta" under "op. mode" and set the value between 2 and 10 °C.

If there are accessories for cooling, you can also set the brine pump's speed during passive cooling operation here (the brine pump then runs in manual operation).

If the continuous operating mode (see "Menu 5.1.8 - operating mode brine pump", page 43) has been selected one can also choose waiting mode. The circulation pump continues to run while the compressor stops.

MENU 5.1.10 - OP. MOD HEAT MED PUMP

op. mode

Setting range: auto, intermittent

Default value: auto

Set the operating mode of the heating medium pump here.

auto: The heating medium pump runs according to the current operating mode for F1253.

intermittent: The heating medium pump starts approx. 20 seconds before, and stops at the same time as, the compressor.

MENU 5.1.11 - PUMP SPEED HEATING MEDIUM

op. mode

Setting range: auto / manual

Default value: auto

Manual setting, hot water

Setting range: 1 - 100 %

Factory setting: 70 %

Manual setting, heating

Setting range: 1 - 100 %

Default values: 70 %

Manual setting, pool

Setting range: 1 - 100 %

Default values: 70 %

speed in wait mode

Setting range: 1 - 100 %

Default values: 30 %

min. allowed speed

Setting range: 1 - 50 %

Default values: 1 %

max. allowed speed

Setting range: 50 - 100 %

Default values: 100 %

speed active cooling (accessory is required)

Setting range: 1 - 100 %

Default values: 70 %

speed passive cooling (accessory is required)

Setting range: 1 - 100 %

Default values: 70 %

Set the speed at which the heating medium pump is to operate in the present operating mode. Select "auto" if the speed of the heating medium pump is to be regulated automatically (factory setting) for optimal operation.

If "auto" is activated for heating operation you can also make the setting "max. allowed speed" which restricts the heating medium pump and does not allow it to run at a higher speed than the set value.

For manual operation of the heating medium pump, deactivate "auto" for the current operating mode and set the value to between 0 and 100% (the previously set value for "max. allowed speed" no longer applies).

"heating" means heating operating mode for the heating medium pump.

"speed in wait mode" means heating or cooling operating mode for the heating medium pump, but when the heat pump requires neither compressor operation nor electric additional heat and slows down.

"hot water" means hot water operating mode for the heating medium pump.

"pool" (accessory required) means pool heating operating mode for the heating medium pump.

"cooling" (accessory required) means operating mode cooling for the heating medium pump.

If there are accessories for cooling present or if the heat pump has a built-in function for cooling you can also set the heating medium pump speed during active respectively cooling operating modes (the heating medium pump then runs in manual operation).

MENU 5.1.12 - INTERNAL ELECTRICAL ADDITION

set max electrical add.

Setting range F1253-4/6 1x230V: 0 - 4.5 kW

Setting range F1253-4/6 3x400V: 0 - 6.5 kW

Factory setting F1253-4/6 1x230V: 4.5 kW

Factory setting F1253-4/6 3x400V: 6 kW

fuse size

Setting range: 1 - 400 A

Default values: 25 A

transformation ratio

Setting range: 300 - 3000

Factory setting: 300

Here you set the max. electrical output of the internal electrical addition in F1253 and the fuse size for the installation.

"detect phase order": Here, you also check which current sensor is installed on which incoming phase to the property (this only applies if you have current sensors installed, see page 25). Check by selecting "detect phase order" and pressing the OK button.

The results of these checks appear just below the menu selection "detect phase order".



TIP!

Search again if the phase detection fails. The detection process is very sensitive and is easily affected by other appliances in the accommodation.

"*transformation ratio*": The transformer ratio can be changed to match different types of current sensor. The factory setting is adjusted according to the enclosed current sensors.

MENU 5.1.14 - FLOW SET. CLIMATE SYSTEM

presettings

Setting range: radiator, floor heat., rad. + floor heat., DOT °C

Default value: radiator

Setting range DOT: -40.0 – 20.0 °C

Factory setting DOT: -18.0 °C

own setting

Setting range dT at DOT: 0.0 – 25.0

Factory setting dT at DOT: 10.0

Setting range DOT: -40.0 – 20.0 °C

Factory setting DOT: -18.0 °C

The type of heating distribution system the heating medium pump (GP1) works towards is set here.

dT at DOT is the difference in degrees between flow and return temperatures at dimensioned outdoor temperature.

MENU 5.1.22 - HEAT PUMP TESTING



CAUTION!

This menu is intended for testing F1253 according to different standards.

Use of this menu for other reasons may result in your installation not functioning as intended.

This menu contains several sub-menus, one for each standard.

MENU 5.1.24 - BLOCKFREQ

blockFreq 1

Selectable setting range in the display:

start: 17 – 115 Hz

stop: 22 – 120 Hz

Maximum setting range: 50 Hz.

blockFreq 2

Selectable setting range in the display:

start: 17 – 115 Hz

stop: 22 – 120 Hz

Maximum setting range: 50 Hz.

Here you can set a frequency range where the compressor is blocked. The parameters for the setting range differ depending on which product is controlled by the setting.



CAUTION!

A large blocked frequency range can cause the compressor to run jerkily.

MENU 5.2 - SYSTEM SETTINGS

Make different system settings for the heat pump here, e.g. which accessories are installed.

There are two ways of activating connected accessories. You can either highlight the alternative in the list or use the automatic function "search installed acc."

search installed acc.

Mark "search installed acc." and press the OK button to automatically find connected accessories for F1253.



NOTE!

Certain accessories are not found automatically, but must be selected manually, see menu 5.4.



CAUTION!

Only mark the option for ground water pump if the accessory AXC 40 is to be used to control the circulation pump.

Make different system settings for the heat pump here, e.g. which accessories are installed.

MENU 5.2.4 - ACCESSORIES

Inform the heat pump which accessories are installed here.

There are two ways of activating connected accessories. You can either mark the alternative in the list or use the automatic function "search installed acc."

search installed acc.

Mark "search installed acc." and press the OK button to automatically find connected accessories for F1253.



NOTE!

Certain accessories are not found with the search function, but must be selected instead in menu 5.4.



CAUTION!

Only mark the option for ground water pump if the accessory AXC 40 is to be used to control the circulation pump.

MENU 5.3 - ACCESSORY SETTINGS

The operating settings for accessories that are installed and activated are made in the sub-menus for this.

MENU 5.3.1 - FLM

continuous pump op.

Setting range: on/off

Factory setting: off

pump speed

Setting range: 1 – 100%

Factory setting: 100 %

time between defrosts

Setting range: 1 – 30 h

Default value: 10 h

months btwn filter alarms

Setting range: 1 – 12

Default value: 3

activate cooling

Setting range: on/off

Factory setting: off

continuous pump op.: Select for continuous operation of the circulation pump in the exhaust air module.

pump speed: Set the desired speed for the circulation pump in the exhaust air module.

time between defrosts: Here, you can set the minimum time that must pass between defrosts of the heat exchanger in the exhaust air module.

When the exhaust air module is in operation the heat exchanger is cooled so that ice builds up on it. When too much ice builds up the heat transfer capacity of the heat exchanger is reduced and defrosting is required. Defrosting warms up the heat exchanger so that the ice melts and runs off via the condensation hose.

months btwn filter alarms: Here, you can set how many months should pass before the heat pump notifies that it is time to clean the filter in the exhaust air module.

Clean the exhaust air module's air filter regularly, how often depends on the amount of dust in the ventilation air.

activate cooling: Here, you can activate cooling via the exhaust air module. When the function has been activated, the cooling settings are displayed in the menu system.



TIP!

See the accessory installation instructions for function description.

MENU 5.3.2 - SHUNT CONTROLLED ADD. HEAT

prioritised additional heat

Setting range: on/off

Factory setting: off

start diff additional heat

Setting range: 0 – 2000 DM

Default values: 400 DM

minimum running time

Setting range: 0 – 48 h

Default value: 12 h

min temp.

Setting range: 5 – 90 °C

Default value: 55 °C

mixing valve amplifier

Setting range: 0.1 – 10.0

Default value: 1.0

mixing valve step delay

Setting range: 10 – 300 s

Default values: 30 s

Set when the addition is to start, the minimum run time and the minimum temperature for external addition with shunt here. External addition with shunt is for example a wood/oil/gas/pellet boiler.

You can set shunt valve amplification and shunt valve waiting time.

Selecting "prioritised additional heat" uses the heat from the external additional heat instead of the heat pump. The shunt valve is regulated as long as heat is available, otherwise the shunt valve is closed.



TIP!

See the accessory installation instructions for function description.

MENU 5.3.3 - EXTRA CLIMATE SYSTEM

use in heating mode

Setting range: on/off

Factory setting: on

use in cooling mode

Setting range: on/off

Factory setting: off

mixing valve amplifier

Setting range: 0.1 – 10.0

Default value: 1.0

mixing valve step delay

Setting range: 10 – 300 s

Default values: 30 s

Contr. pump GP10

Setting range: on/off

Factory setting: off

Here, you select which climate system (2 - 8) you wish to set.

use in heating mode: If the heat pump is connected to a climate system(s) for cooling, any condensation can take place in this/these. Check that "use in heating mode" has been selected for the climate system(s) that is/are not adapted for cooling. This setting means that the sub-shunt for the extra climate system closes when cooling operation is activated.

use in cooling mode: Select "use in cooling mode" for climate systems that are adapted to handle cooling. For 2-pipe cooling you can select both "use in cooling mode" and "use in heating mode", while for 4-pipe cooling you can only select one option.

 **NOTE!**

This setting option only appears if the heat pump is activated for cooling operation.

mixing valve amplifier, mixing valve step delay: Here, you set the shunt amplification and shunt waiting time for the various extra climate systems that are installed.

Contr. pump GP10: Here, you can set the speed of the circulation pump manually.

See the accessory installation instructions for function description.

MENU 5.3.4 - SOLAR HEATING**start delta-T**

Setting range: 1 – 40 °C

Default value: 8 °C

stop delta-T

Setting range: 0 – 40 °C

Default value: 4 °C

max. tank temperature

Setting range: 5 – 110 °C

Default value: 95 °C

max. solar collector temp.

Setting range: 80 – 200 °C

Default value: 125 °C

anti-freeze temperature

Setting range: -20 – +20 °C

Default value: 2 °C

start solar collector cooling

Setting range: 80 – 200 °C

Default value: 110 °C

passive recharging - activation temperature

Setting range: 50 – 125 °C

Factory setting: 110 °C

passive recharging - deactivation temperature

Setting range: 30 – 90 °C

Factory setting: 50 °C

active recharging - activating dT

Setting range: 8 – 60 °C

Factory setting: 40 °C

active recharging - deactivating dT

Setting range: 4 – 50 °C

Factory setting: 20 °C

start delta-T, stop delta-T: Here, you can set the temperature difference between solar panel and solar tank at which the circulation pump will start and stop.

max. tank temperature, max. solar collector temp.: Here, you can set the maximum temperatures in the tank and solar panel respectively at which the circulation pump will stop. This is to protect against excess temperatures in the solar tank.

If the unit has an anti-freeze function, solar panel cooling and/or passive/active recharging you can activate them here. When the function has been activated, you can make settings for them. "solar panel cooling", "passive recharging" and "active recharging" cannot be combined, only one function can be activated.

freeze protection

anti-freeze temperature: Here, you can set the temperature in the solar panel at which the circulation pump is to start to prevent freezing.

solar panel cooling

start solar collector cooling: If the temperature in the solar panel is higher than this setting, at the same time as the temperature in the solar tank is higher than the set maximum temperature, the external function for cooling is activated.

passive recharging

activation temperature: If the temperature in the solar panel is higher than this setting, the function is activated. However, the function is blocked for an hour if the temperature of the brine entering the heat pump (BT10) is higher than the set value for "max brine in" in menu 5.1.7.

deactivation temperature: If the temperature in the solar panel is lower than this setting, the function is deactivated.

active recharging

activating dT: If the difference between the temperature in the solar panel (BT53) and the temperature of the brine entering the heat pump (BT10) is greater than this setting, the function is activated. However, the function is blocked for an hour if the temperature of the brine entering the heat pump (BT10) is higher than the set value for "max brine in" in menu 5.1.7.

deactivating dT: If the difference between the temperature in the solar panel (BT53) and the temperature of the brine entering the heat pump (BT10) is lower than this setting, the function is deactivated.

See the accessory installation instructions for function description.

MENU 5.3.6 - STEP CONTROLLED ADD. HEAT

start diff additional heat

Setting range: 0 – 2000 DM

Default values: 400 DM

diff. between additional steps

Setting range: 0 – 1000 DM

Default values: 100 DM

max step

Setting range

(binary stepping deactivated): 0 – 3

Setting range

(binary stepping activated): 0 – 7

Default value: 3

binary stepping

Setting range: on/off

Factory setting: off

Make settings for step controlled addition here. Step controlled addition is for example an external electric boiler.

It is possible, for example, to select when the additional heat is to start, to set the maximum number of permitted steps and whether binary stepping is to be used.

When binary stepping is deactivated (off), the settings refer to linear stepping.

See the accessory installation instructions for function description.

MENU 5.3.8 - HOT WATER COMFORT

activating the mixing valve

Setting range: on/off

Factory setting: off

outgoing hot water

Setting range: 40 – 65 °C

Default value: 55 °C

mixing valve amplifier

Setting range: 0.1 – 10.0

Default value: 1.0

mixing valve step delay

Setting range: 10 – 300 s

Default values: 30 s

Make settings for the hot water comfort here.

See the accessory installation instructions for function description.

activating the mixing valve: Activated if mixer valve is installed and it is to be controlled from F1253. When the option is active, you can set the outgoing hot water temperature, shunt amplification and shunt waiting time for the mixer valve.

outgoing hot water: Here, you can set the temperature at which the mixer valve is to restrict hot water from the water heater.

MENU 5.3.11 - MODBUS

address

Factory setting: address 1

word swap

Factory setting: not activated

As from Modbus 40 version 10, the address can be set between 1 – 247. Earlier versions have a fixed address (address 1).

Here, you can select if you want to have "word swap" instead of the preset standard "big endian".

See the accessory installation instructions for function description.

MENY 5.3.12 - EXHAUST/SUPPLY AIR MODULE

months btwn filter alarms

Setting range: 1 – 24

Default value: 3

lowest extract air temp.

Setting range: 0 – 10 °C

Default value: 5 °C

bypass at excess temperature

Setting range: 2 – 10 °C

Default value: 4 °C

bypass during heating

Setting range: on/off

Factory setting: off

cut-out val. exh. air temp.

Setting range: 5 – 30 °C

Default value: 25 °C

product

Setting range: ERS S10, ERS 20/ERS 30

Factory setting: ERS 20 / ERS 30

action level monitor

Setting range: off, blocked, level monitor

Default value: level monitor

months btwn filter alarms: Set how often the filter alarm is to be displayed.

lowest extract air temp.: Set the minimum extract air temperature to prevent the build-up of ice on the heat exchanger. The supply air fan speed reduces, if the extract air temperature (BT21) is lower than the set value.

bypass at excess temperature: If a room sensor is installed, you set the over-temperature at which the bypass damper (QN37) will open here.

bypass during heating: Activate whether the bypass damper (QN37) will also be allowed to open during heat production.

cut-out val. exh. air temp.: If no room sensor is installed, you set the exhaust air temperature at which the bypass damper (QN37) will open here.

product: Here, you set which ERS model is installed.

action level monitor: If "level monitor" is selected, the product issues an alert and the fans stop when the input closes. If "blocked" is selected, text in operating info shows that the input is closed. The fans stop until the input is open.



TIP!

See the installation instructions for ERS and HTS for a function description.

MENU 5.3.16 - HUMIDITY SENSOR

climate system 1 HTS

Setting range: 1–4

Default value: 1

limit RH in the room, syst.

Setting range: on/off

Factory setting: off

prevent condensation, syst.

Setting range: on/off

Factory setting: off

limit RH in the room, syst.

Setting range: on/off

Factory setting: off

Up to four humidity sensors (HTS 40) can be installed.

Here you select whether your system(s) is/are to limit the relative humidity level (RH) during heating or cooling operation.

You can also choose to limit min. cooling supply and calculated cooling supply to prevent condensation on pipes and components in the cooling system.

See the Installer Manual for HTS 40 for function description.

MENU 5.3.21 - FLOW SENSOR / ENERGY METER

Flow sensor

set mode

Setting range: EMK150 / EMK300/310/05 / EMK500

Factory setting: EMK150

energy per pulse

Setting range: 0 – 10000 Wh

Factory setting: 1000 Wh

pulses per kWh

Setting range: 1 – 10000

Factory setting: 500

Energy meter

set mode

Setting range: energy per pulse / pulses per kWh

Default value: energy per pulse

energy per pulse

Setting range: 0 – 10000 Wh

Factory setting: 1000 Wh

pulses per kWh

Setting range: 1 – 10000

Factory setting: 500

Up to two flow sensors (EMK) / energy meters can be connected on the input board AA3, terminal block X22 and X23. Select these in menu 5.2.4 - accessories.

Flow sensor (Energy measurement kit EMK)

A flow sensor (EMK) is used to measure the amount of energy produced and supplied by the heating installation for hot water and heating in the building.

The function of the flow sensor is to measure flow and temperature differences in the charge circuit. The value is presented in the display on a compatible product.

energy per pulse: Here you set the amount of energy to which each pulse will correspond.

pulses per kWh: Here you set the number of pulses per kWh that are sent to F1253.

Energy meter (Electricity meter)

The energy meter(s) is used to send pulse signals every time a certain amount of energy has been consumed.

energy per pulse: Here you set the amount of energy to which each pulse will correspond.

pulses per kWh: Here you set the number of pulses per kWh that are sent to F1253.

MENU 5.4 - SOFT IN/OUTPUTS

Here, you can select which input/output on the input board (AA3) the external contact function (page 25) will be connected to.

Selectable inputs on terminal block AUX 1-5 (AA3-X6:9-18) and output AA3-X7 on the input board.

MENU 5.5 - FACTORY SETTING SERVICE

All settings can be reset (including settings available to the user) to default values here.

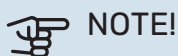

NOTE!

When resetting, the start guide is displayed the next time the heat pump is restarted.

MENU 5.6 - FORCED CONTROL

You can force control the different components in the heat pump and any connected accessories here.



CAUTION!

Forced control is only intended to be used for troubleshooting purposes. Using the function in any other way may cause damage to the components in your climate system.

MENU 5.7 - START GUIDE

When the heat pump is started for the first time the start guide starts automatically. Start it manually here.

See page 30 for more information about the start guide.

MENU 5.8 - QUICK START

It is possible to start the compressor from here.



NOTE!

There must be a heating, cooling or hot water demand to start the compressor.



CAUTION!

Do not quick start the compressor too many times over a short period of time, as this could damage the compressor and its surrounding equipment.

MENU 5.9 - FLOOR DRYING FUNCTION

length of period 1 - 7

Setting range: 0 – 30 days

Factory setting, period 1 – 3, 5 – 7: 2 days

Factory setting, period 4: 3 days

temp. period 1 - 7

Setting range: 15 – 70 °C

Default value:

temp. period 1	20 °C
temp. period 2	30 °C
temp. period 3	40 °C
temp. period 4	45 °C
temp. period 5	40 °C
temp. period 6	30 °C
temp. period 7	20 °C

Set the function for under floor drying here.

You can set up to seven time periods with different calculated supply temperatures. If fewer than seven periods are to be used, set the remaining periods to 0 days.

Mark the active window to activate the underfloor drying function. A counter at the bottom shows the number of days the function has been active. The function counts degree minutes as during normal heating operation but for the supply temperatures that are set for the respective period.



CAUTION!

During under floor drying, the heating medium pump in 100% runs, regardless of the setting in menu 5.1.10.



TIP!

If operating mode "add. heat only" is to be used, select it in menu 4.2.

For a more even flow temperature the addition can be started earlier by setting "start for addition" in menus 4.9.2 to -80. When set under floor drying periods have stopped, reset the menus 4.2 and 4.9.2 as per previous settings.



TIP!

It is possible to save a floor drying log that shows when the concrete slab has reached the correct temperature. See section "Logging floor drying" on page 56.

MENU 5.10 - CHANGE LOG

Read off any previous changes to the control system here.

The date, time, ID no. (unique to particular setting) and the new set value are shown for every change.



NOTE!

The change log is saved at restart and remains unchanged after factory setting.

Service

Service actions



CAUTION!

Servicing should only be carried out by persons with the necessary expertise.

When replacing components on F1253 only replacement parts from NIBE may be used.

EMERGENCY MODE



CAUTION!

Switch (SF1) must not be set to "I" or  before F1253 has been filled with water. Components in the product could be damaged.

Emergency mode is used in event of operational interference and in conjunction with service. Hot water is not produced in emergency mode.

Emergency mode is activated by setting switch (SF1) to "". This means that:

- The status lamp illuminates yellow.
- The display is not lit and the control computer is not connected.
- The temperature at the immersion heater is controlled by the thermostat (FQ10). It can be set either to 35 or 45°C.
- The compressor and the brine pump are switched off and only the heating medium pump and the electric additional heat are active. The electric additional heat power in emergency mode is set on the immersion heater board (AA1). See page 24 for instructions.

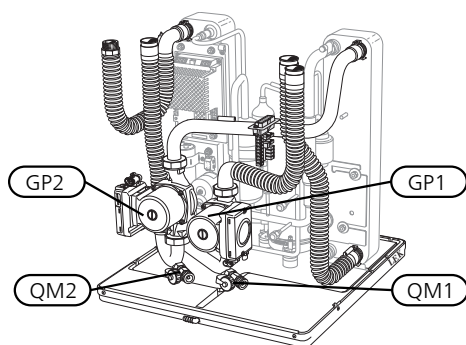

The image shows an example of how a cooling module can appear.

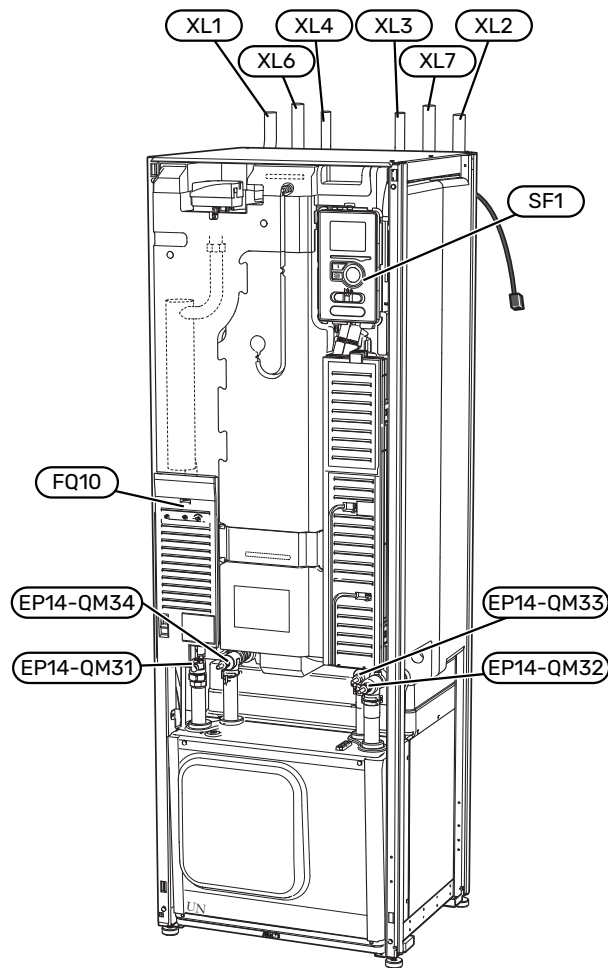

DRAINING THE HOT WATER HEATER

The siphon principle is used to empty the hot water heater. This can be done either via the drain valve on the incoming cold water pipe or by inserting a hose into the cold water connection.



CAUTION!

There may be some hot water, risk of scalding.

DRAINING THE CLIMATE SYSTEM

In order to carry out service on the climate system, it may be easier to drain the system first. This can be done in different ways depending on what needs doing:



CAUTION!

There may be some hot water, risk of scalding.

Draining the climate system in the cooling module

If, for example, the heating medium pump needs to be replaced or the cooling module needs to be serviced in some other way, drain the climate system as follows:

1. Close the shut-off valves to the climate system (EP14-QM31) and (EP14-QM32).
2. Connect a hose to the drain valve (QM1) and open the valve. Some liquid will run out.
3. Air must enter the system to allow the remaining liquid to run out. To let in air, loosen the connection slightly at the shut-off valve (EP14-QM32) that joins the heat pump with the cooling module.

When the climate system is empty, the required service can be carried out and/or any components can be replaced.

Draining the climate system in the heat pump

If F1253 requires servicing, drain the climate system as follows:

1. Close the shut-off valves outside the heat pump for the climate system (return and supply line).
2. Connect a hose to the drain valve (QM1) and open the valve. Some liquid will run out.
3. Air must enter the system to allow the remaining liquid to run out. To let in air, loosen the connection slightly at the shut-off valve that joins the climate system and the heat pump by the connection (XL2).

When the climate system is empty, the required service can be carried out.

Draining the entire climate system

If the entire climate system requires draining, do this as follows:

1. Connect a hose to the drain valve (QM1) and open the valve. Some liquid will run out.
2. Air must get into the system for the remaining liquid to run out. To allow air in, unscrew the bleed screw on the highest radiator in the house.

When the climate system is empty, the required service can be carried out.

EMPTYING THE BRINE SYSTEM

In order to service the brine system it may be easier to drain the system first. This can be done in different ways depending on what needs doing:

Draining the brine system in the cooling module

If, for example, the brine pump requires replacing or the cooling module requires servicing, drain the brine system by:

1. Close the shut-off valves to brine system (EP14-QM33) and (EP14-QM34).
2. Connect a hose to the drain valve (QM2), place the other opening of the hose in a vessel and open the valve. A small amount of brine will flow into the vessel.
3. Air must get into the system in order for the remaining brine to run out. To let in air, slacken off the connection slightly at the shut-off valve (EP14-QM33) that joins the heat pump with the cooling module.

When the brine system is empty, the required service can be carried out.

Draining the brine system in the heat pump

If the heat pump requires servicing, drain the brine system by:

1. Close the shut-off valve outside the heat pump for the brine system.
2. Connect a hose to the drain valve (QM2), place the other opening of the hose in a vessel and open the valve. A small amount of brine will flow into the vessel.
3. Air must enter the system, to allow the remaining brine to run out. To let in air, loosen the connection slightly at the shut-off valve that joins the brine side with the heat pump by the connection (XL7).

When the brine system is empty, the required service can be carried out.

HELPING THE CIRCULATION PUMP TO START

1. Turn off F1253 by setting the switch (SF1) to "0".
2. Remove the front cover
3. Remove the cover for the cooling module.
4. Loosen the venting screw (QM5) with a screwdriver. Hold a cloth around the screwdriver blade, because a small amount of water may run out.
5. Insert a screwdriver and turn the pump motor around.
6. Screw in the venting screw (QM5).
7. Start F1253 by setting the switch (SF1) to "I", and check that the circulation pump is working.

It is usually easier to start the circulation pump with F1253 running, and with the switch (SF1) set to "I". If the circulation pump is helped to start while F1253 is running, be prepared for the screwdriver to jerk when the pump starts.

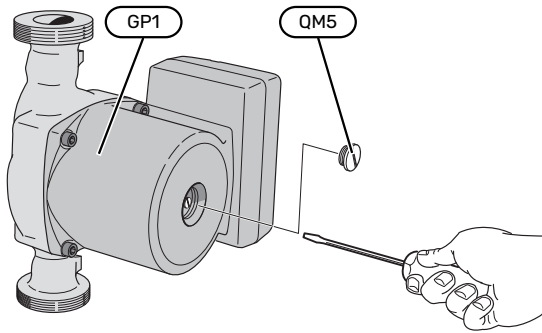

The image shows an example of what a circulation pump can look like.

TEMPERATURE SENSOR DATA

Temperature (°C)	Resistance (kOhm)	Voltage (VDC)
-10	56.20	3.047
0	33.02	2.889
10	20.02	2.673
20	12.51	2.399
30	8.045	2.083
40	5.306	1.752
50	3.583	1.426
60	2.467	1.136
70	1.739	0.891
80	1.246	0.691

PULLING OUT THE COOLING MODULE

The cooling module can be pulled out for service and transport.



CAUTION!

Switch off the heat pump and cut the power with the safety switch.



NOTE!

Remove the front cover according to the description on page 8.

1. Close the shut-off valves (EP14-QM31), (EP14-QM32), (EP14-QM33) and (EP14-QM34).
Drain the compressor module according to the instructions on page 52

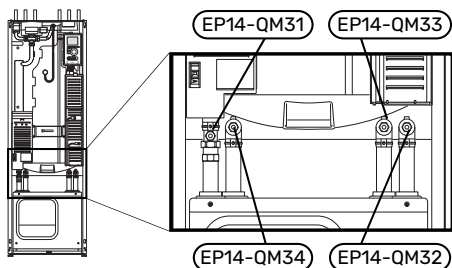

2. Remove the insulation.
3. Remove the locking plate.
4. Disconnect the pipe connection under the shut-off valve (EP14-QM31).

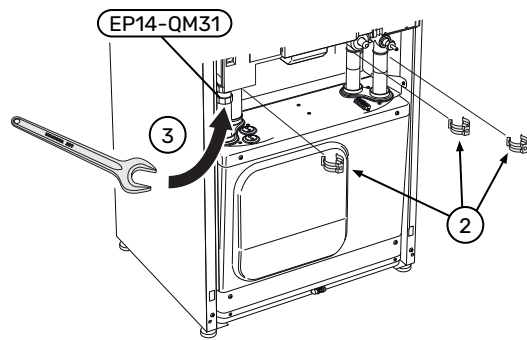

5. Remove the two screws.

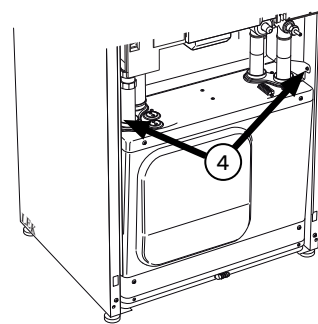

6. Remove the connection from the base board (AA2) using a screwdriver.

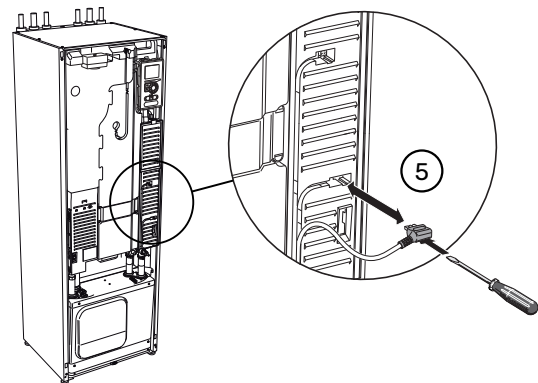

7. Disconnect the connectors (A) and (B) from the underside of the PCB box.
8. Disconnect the connector (C) from the electric addition PCB (AA1) using a screwdriver.
9. Disconnect the connector (D) from the joint board (AA100).
10. Carefully pull out the cooling module.

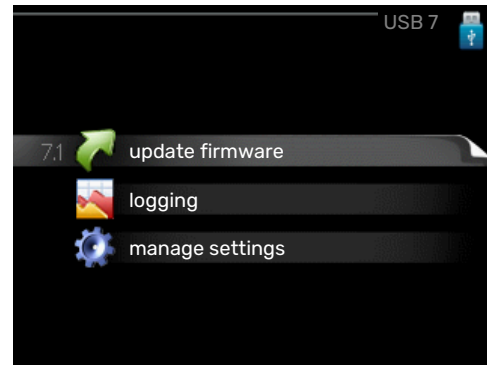
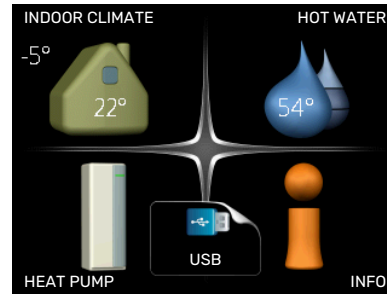
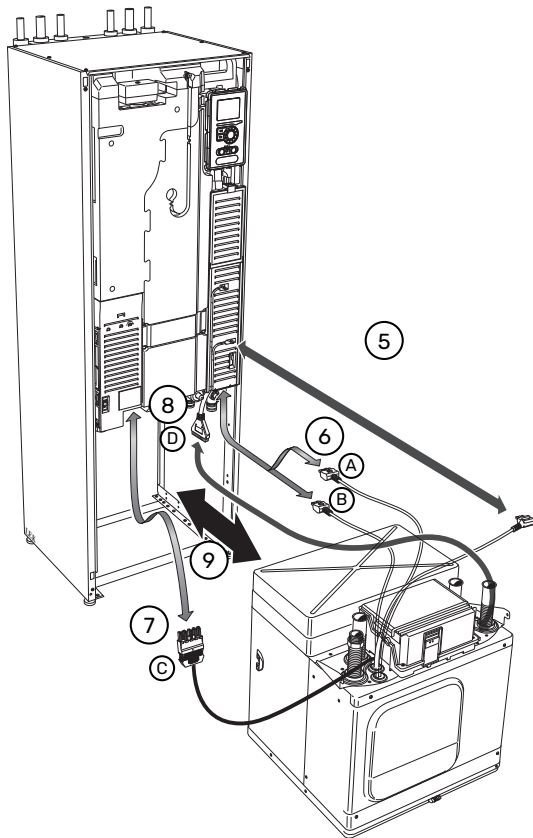

When a USB memory is connected, a new menu (menu 7) appears in the display.



TIP!

The cooling module is installed in reverse order.



CAUTION!

At reinstallation, the supplied O-rings must replace the existing ones at the connections to the heat pump (see image).

Menu 7.1 - "update firmware"

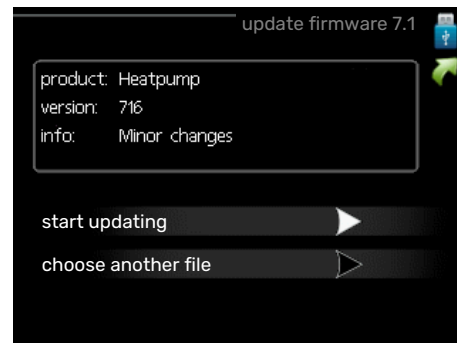

Here, you can update the software in F1253.



CAUTION!

For the following functions to work the USB memory must contain files with software for F1253 from NIBE.

USB SERVICE OUTLET

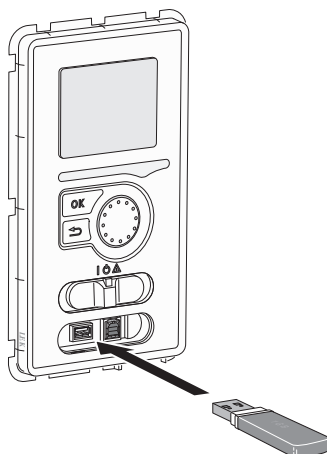

The display unit is equipped with a USB socket that can be used to update the software and save logged information in F1253.

The fact box at the top of the display shows information (always in English) of the most probable update that the update software has selected from the USB memory.

This information states the product for which the software is intended, the software version and general information about it. If you want a file other than the one selected, the correct file can be selected through "choose another file".

start updating

Select "start updating" if you want to start the update. You are asked whether you really want to update the software. Respond "yes" to continue or "no" to undo.

If you responded "yes" to the previous question the update starts and you can now follow the progress of the update on the display. When the update is complete F1253 restarts.



TIP!

A software update does not reset the menu settings in F1253.



NOTE!

If the update is interrupted before it is complete (for example, by a power cut), the software can be reset to the previous version if the OK button is held in during start-up until the green lamp comes on (takes about 10 seconds).

choose another file

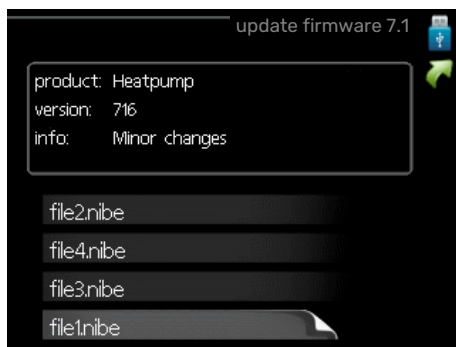

Select "choose another file" if you do not want to use the suggested software. When you scroll through the files, information about the marked software is shown in a fact box just as before. When you have selected a file with the OK button you will return to the previous page (menu 7.1) where you can choose to start the update.

Menu 7.2 - logging

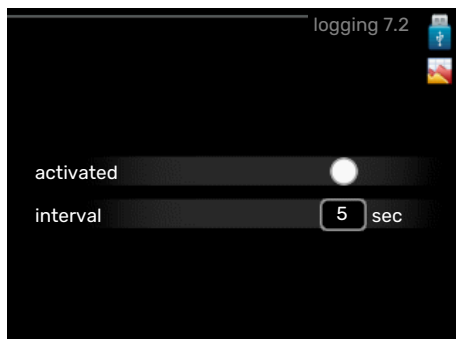

Setting range: 1 s – 60 min

Factory setting range: 5 s

Here you can choose how current measurement values from F1253 should be saved onto a log file on the USB memory.

1. Set the desired interval between loggings.
2. Tick "activated".
3. The present values from F1253 are saved in a file in the USB memory at the set interval until "activated" is unticked.



NOTE!

Untick "activated" before removing the USB memory.

Logging floor drying

Here you can save a floor drying log on the USB memory and in this way see when the concrete slab reached the correct temperature.

- Make sure that "floor drying function" is activated in menu 5.9.
- Select "logging floor drying activated".
- A log file is now created, where the temperature and the immersion heater output can be read off. Logging continues until "logging floor drying activated" is deselected or until "floor drying function" is stopped.



NOTE!

Deselect "logging floor drying activated" before you remove the USB memory.

Menu 7.3 - manage settings

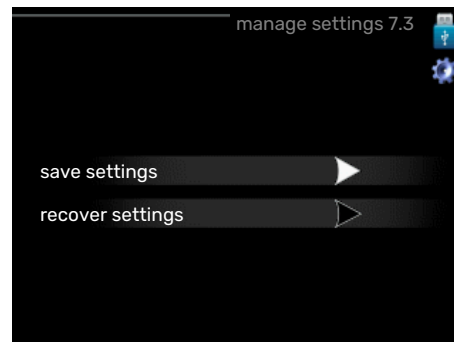

save settings

Setting option: on/off

recover settings

Setting option: on/off

In this menu, you save/upload menu settings to/from a USB memory stick.

save settings: Here, you save menu settings in order to restore them later or to copy the settings to another F1253.



NOTE!

When you save menu settings to the USB memory, you replace any previously saved settings on the USB memory.

recover settings: Here, you upload all menu settings from the USB memory stick.



NOTE!

Resetting of menu settings from the USB memory cannot be undone.

Disturbances in comfort

In most cases, F1253 notes a malfunction (a malfunction can lead to disruption in comfort) and indicates this with alarms, and instructions for action, in the display.

INFO MENU

All the heat pump measurement values are gathered under menu 3.1 in the heat pump menu system. Looking through the values in this menu can often simplify finding the source of the fault. See help menu or user manual for more information about menu 3.1.

Manage alarm

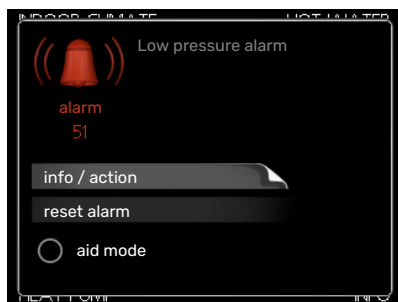

In the event of an alarm, some kind of malfunction has occurred, which is indicated by the status lamp changing from green continuously to red continuously. In addition, an alarm bell appears in the information window.

ALARM

In the event of an alarm with a red status lamp, a malfunction has occurred that the heat pump cannot remedy itself. By turning the control knob and pressing the OK button, you can see in the display what type of alarm it is and reset it. You can also choose to set the heat pump to aid mode.

info / action Here you can read what the alarm means and receive tips on what you can do to correct the problem that caused the alarm.

reset alarm In many cases, it is sufficient to select "reset alarm" for the product to revert to normal operation. If a green light comes on after selecting "reset alarm", the alarm has been remedied. If the red light is still on, and a menu called "alarm" is visible in the display, the problem causing the alarm still remains.

aid mode "aid mode" is a type of emergency mode. This means that the heat pump produces heat and/or hot water even though there is some kind of problem. This could mean that the heat pump's compressor is not running. In this case, the immersion heater produces heat and/or hot water.



NOTE!

To select aid mode an alarm action must be selected in the menu 5.1.4.



NOTE!

Selecting "aid mode" is not the same as correcting the problem that caused the alarm. The status lamp will therefore continue to be red.

Troubleshooting

If the operational interference is not shown in the display the following tips can be used:

BASIC ACTIONS

Start by checking the following items:

- The switch's (SF1) position.
- Group and main fuses of the accommodation.
- The property's earth circuit breaker.
- Heat pump's earth-fault breaker.
- Miniature circuit-breaker for F1253 (FC1).
- Temperature limiter for F1253 (FQ10).
- Correctly set load monitor.

LOW HOT WATER TEMPERATURE OR NO HOT WATER

- Mixing valve (if there is one installed) set too low.
 - Adjust the mixer valve.
- F1253 in incorrect operating mode.
 - Enter menu 4.2. If mode "auto" is selected, select a higher value on "stop additional heat" in menu 4.9.2.
 - If mode "manual" is selected, select "addition".
- Large hot water consumption.
 - Wait until the hot water has heated up. Temporarily increased hot water capacity (temporary lux) can be activated in menu 2.1.
- Too low hot water setting.
 - Enter menu 2.2 - "comfort mode" and select a higher comfort mode.
- Too low or no operating prioritisation of hot water.
 - Enter menu 4.9.1 and increase the time for when hot water is to be prioritised. Note that if the time for hot water is increased, the time for heating production is reduced, which can give lower/uneven room temperatures.

LOW ROOM TEMPERATURE

- Closed thermostats in several rooms.
 - Set the thermostats to max, in as many rooms as possible. Adjust the room temperature via menu 1.1, instead of choking the thermostats.

See the "Saving tips" section in the User manual for more detailed information about how to best set the thermostats.

- Too low set value on the automatic heating control.
 - Enter menu 1.1 - "temperature" and adjust the offset heating curve up. If the room temperature is only low in cold weather, the curve slope in menu 1.9.1 - "heating curve" may need to be adjusted upwards.
- F1253 in incorrect operating mode.
 - Enter menu 4.2. If mode "auto" is selected, select a higher value on "stop heating" in menu 4.9.2.
 - If mode "manual" is selected, select "heating". If this is not enough, select "addition".
- Too low or no operating prioritisation of heat.
 - Enter menu 4.9.1 and increase the time for when heating is to be prioritised. Note that if the time for heating is increased the time for hot water production is reduced, which can give smaller amounts of hot water.
- "Holiday mode" activated in menu 4.7.
 - Enter menu 4.7 and select "Off".
- External switch for changing room temperature activated.
 - Check any external switches.
- Air in the climate system.
 - Vent the climate system (see page 29).
- Closed valves (QM31), (QM32) to the climate system.
 - Open the valves.

HIGH ROOM TEMPERATURE

- Too high set value on the automatic heating control.
 - Enter menu 1.1 - "temperature" and reduce the offset heating curve. If the room temperature is only high in cold weather, the curve slope in menu 1.9.1 - "heating curve" may need to be adjusted downwards.
- External switch for changing room temperature activated.
 - Check any external switches.

UNEVEN ROOM TEMPERATURE.

- Incorrectly set heating curve.
 - Fine-tune the heating curve in menu 1.9.1
- Too high set value on "dT at DOT"..
 - Enter menu 5.1.14 - "flow set. climate system" and reduce the value of "dT at DOT".
- Uneven flow over the radiators.
 - Adjust the flow distribution over the radiators.

LOW SYSTEM PRESSURE

- Not enough water in the climate system.
 - Top up the water in the climate system (see page 29).

COMPRESSOR DOES NOT START

There is no heating or hot water demand, nor cooling demand (accessory is required for cooling).

- F1253 does not call on heating, hot water or cooling.

Compressor blocked due to the temperature conditions.

- Wait until the temperature is within the product's working range.

Minimum time between compressor starts has not been reached.

- Wait for at least 30 minutes and then check if the compressor has started.

Alarm tripped.

- Follow the display instructions.

"add. heat only" is selected.

- Switch to "auto" or "manual" in menu 4.2 - "op. mode".

WHINING NOISE IN THE RADIATORS

- Closed thermostats in the rooms and incorrectly set heating curve.
 - Set the thermostats to max. in as many rooms as possible. Adjust the heating curve via menu 1.1, instead of choking the thermostats.
- Circulation pump speed set too high.
 - Enter menu 5.1.11 (pump speed heating medium) and reduce the speed of the circulation pump.
- Uneven flow over the radiators.
 - Adjust the flow distribution between the radiators.

GURGLING SOUND

This part of the troubleshooting chapter only applies if the NIBE FLM accessory is installed.

- Not enough water in the water seal.
 - Refill the water seal with water.
- Choked water seal.
 - Check and adjust the condensation water hose.

Accessories

Detailed information about the accessories and complete accessories list available at nibe.eu.

Not all accessories are available on all markets.

ACTIVE/PASSIVE COOLING IN 4-PIPE SYSTEM ACS 45

ACS 45 is an accessory that makes it possible for your heat pump to control the production of heating and cooling independently of each other.

Part no 067 195

ACTIVE/PASSIVE COOLING HPAC 40

The accessory HPAC 40 is a climate exchange module that is used to supply the building with active and passive cooling.

Part no. 067 076

ENERGY MEASUREMENT KIT EMK 300

This accessory is installed externally and used to measure the amount of energy that is supplied to the hot water/heating/cooling for the house.

Cu pipe Ø22.

Part no. 067 314

EXTERNAL ELECTRIC ADDITIONAL HEAT ELK

These accessories require accessories card AXC 40 (step controlled addition).

ELK 5

Electric heater
5 kW, 1 x 230 V
Part no. 069 025

ELK 8

Electric heater
8 kW, 1 x 230 V
Part no. 069 026

ELK 15

15 kW, 3 x 400 V
Part no. 069 022

ELK 213

7–13 kW, 3 x 400 V
Part no. 069 500

EXTRA SHUNT GROUP ECS

This accessory is used when F1253 is installed in houses with two or more different climate systems that require different supply temperatures.

ECS 40

Max 80 m²
Part no 067 287

ECS 41

Approx. 80–250 m²
Part no 067 288

FREE COOLING PCS 44

This accessory is used when F1253 is installed in an installation with passive cooling.

Part no 067 296

HUMIDITY SENSOR HTS 40

This accessory is used to show and regulate humidity and temperatures during both heating and cooling operation.

Part no. 067 538

EXHAUST AIR MODULE NIBE FLM

NIBE FLM is an exhaust air module designed to combine recovery of mechanical exhaust air with ground source heating.

NIBE FLM

Part no. 067 011

Bracket BAU 40

Part no. 067 666

HRV UNIT ERS

This accessory is used to supply the accommodation with energy that has been recovered from the ventilation air. The unit ventilates the house and heats the supply air as necessary.

ERS S10-400¹

Part no. 066 163

ERS 20-250²

Part no. 066 068

¹ A preheater may be required.

² A preheater may be required.

BASE EXTENSION EF 45

This accessory can be used to create a larger area under F1253.

Part no. 067 152

AUXILIARY RELAY

Auxiliary relay is used to control external 1 to 3 phase loads, such as, for example, oil burners, immersion heaters and circulation pumps.

HR 10

Recommended max fuse for control current 10 A.
Part no 067 309

HR 20

Recommended max fuse for control current 20 A.
Part no. 067 972

COMMUNICATION MODULE FOR SOLAR ELECTRICITY EME 20

EME 20 is used to enable communication and control between inverters for solar cells from NIBE and F1253.

Part no. 057 215

COMMUNICATIONS MODULE MODBUS 40

MODBUS 40 enables F1253 to be controlled and monitored using a DUC (computer sub-centre) in the building. Communication is then performed using MODBUS-RTU.

Part no 067 144

MEASUREMENT KIT FOR SOLAR GENERATED ELECTRICITY EME 10

EME 10 is used to optimise the use of solar generated electricity. EME 10 measures the relevant current from the inverter via a current transformer and can work with all inverters.

Part no. 067 541

LEVEL MONITOR NV 10

Level monitor for extended checks of the brine level.

Part no. 089 315

PASSIVE COOLING PCM 40/PCM 42

PCM 40/PCM 42 makes it possible to obtain passive cooling from rock, ground water or surface soil collectors.

Part no. 067 077 / 067 078

POOL HEATING POOL 40

POOL 40 is used to enable pool heating with F1253.

Part no 067 062

FILLING VALVE KIT KB

Valve kit for filling brine in the collector hose. Includes particle filter and insulation.

KB 25 (max 13 kW)

Part no. 089 368

KB 32 (max. 30 kW)

Part no. 089 971

ROOM UNIT RMU 40

The room unit is an accessory with a built-in room sensor, which allows the control and monitoring of F1253 to be carried out in a different part of your home to where it is located.

Part no 067 064

SOLAR PACKAGE NIBE PV

NIBE PV is a modular system comprising solar panels, assembly parts and inverters, which is used to produce your own electricity.

ACCESSORY CARD AXC 40

This accessory is used to enable connection and control of shunt controlled additional heat, step controlled additional heat, external circulation pump or ground water pump.

Part no. 067 060

BUFFER VESSEL UKV

A buffer vessel is an accumulator tank that is suitable for connection to a heat pump or another external heat source, and can have several different applications.

UKV 40

Part no. 088 470

UKV 100

Part no. 088 207

UKV 200

Part no. 080 300

UKV 300

Part no. 080 301

UKV 500

Part no. 080 114

WATER HEATER/ACCUMULATOR TANK

AHPS

Accumulator tank without an immersion heater with a solar coil (copper corrosion protection) and a hot water coil (stainless steel corrosion protection).

Part no. 256 119

AHP

Volume expansion vessel that is primarily used for expanding the volume together with AHPS.

Part no. 256 118

AHPH

Accumulator tank without an immersion heater with an integrated hot water coil (stainless steel corrosion protection).

Part no. 256 120

Technical data

Dimensions

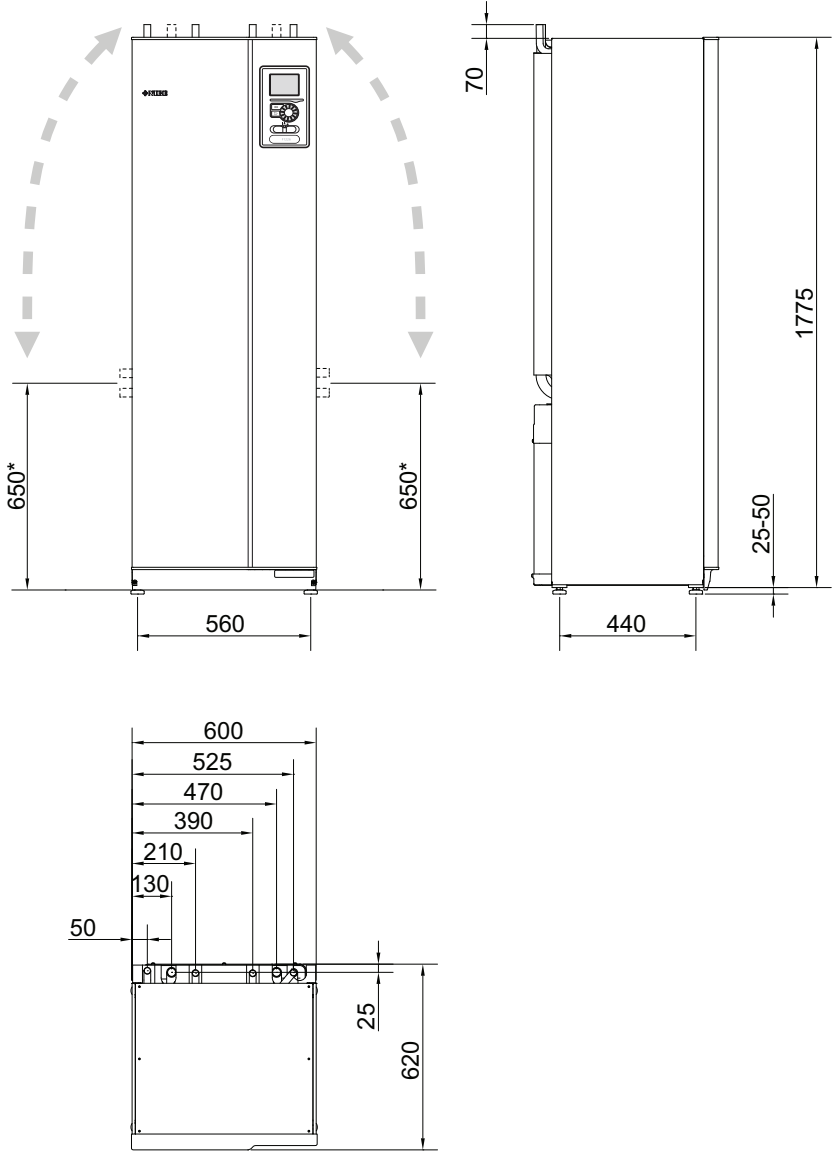

* This dimension applies at 90° angle on the brine pipes (side connection). The dimension can vary approx. ±100 mm vertically as the brine pipes consist in part of flexible pipes.

Electrical data

1X230 V

F1253-4		
Rated voltage		230V ~ 50Hz
Max operating current including 0 – 0.5 kW immersion heater (Recommended fuse rating).	A _{rms}	15(16)
Max operating current including 1 – 1.5 kW immersion heater (Recommended fuse rating).	A _{rms}	20(20)
Max operating current including 2 – 2.5 kW immersion heater (Recommended fuse rating).	A _{rms}	24(25)
Max operating current including 3 – 4 kW immersion heater (Recommended fuse rating).	A _{rms}	30(32)
Max operating current including 4.5 kW immersion heater (Recommended fuse rating).	A _{rms}	33(40)
Additional power	kW	0.5/1/1.5/2/2.5/3 /3.5/4/4.5

F1253-6		
Rated voltage		230V ~ 50Hz
Max operating current including 0 – 0.5 kW immersion heater (Recommended fuse rating).	A _{rms}	15(16)
Max operating current including 1 – 1.5 kW immersion heater (Recommended fuse rating).	A _{rms}	20(20)
Max operating current including 2 – 2.5 kW immersion heater (Recommended fuse rating).	A _{rms}	24(25)
Max operating current including 3 – 4 kW immersion heater (Recommended fuse rating).	A _{rms}	31(32)
Max operating current including 4.5 kW immersion heater (Recommended fuse rating).	A _{rms}	33(40)
Additional power	kW	0.5/1/1.5/2/2.5/3 /3.5/4/4.5

3X400 V

F1253-4		
Rated voltage		400V 3N ~ 50Hz
Max operating current including 0 kW immersion heater (Recommended fuse rating).	A _{rms}	12(16)
Max operating current including 0.5 – 6.5 kW immersion heater (Recommended fuse rating).	A _{rms}	16,2(16)
Additional power	kW	0.5/1/1.5/2/2.5/3 /3.5/4/4.5/5/5.5/6/6.5

F1253-6		
Rated voltage		400V 3N ~ 50Hz
Max operating current including 0 kW immersion heater (Recommended fuse rating).	A _{rms}	12(16)
Max operating current including 0.5 – 6.5 kW immersion heater (Recommended fuse rating).	A _{rms}	17,3(20)
Additional power	kW	0.5/1/1.5/2/2.5/3 /3.5/4/4.5/5/5.5/6/6.5

Technical specifications

1X230 V AND 3X400 V

		F1253-4	F1253-6
Output data according to EN 14511			
Heating capacity (P _H)	kW	1.5 – 4	1.5 – 6
0/35 nominal			
Heating capacity (P _H)	kW	3.15	
Supplied power (P _E)	kW	0.67	
COP		4.72	
0/45 nominal			
Heating capacity (P _H)	kW	2.87	
Supplied power (P _E)	kW	0.79	
COP		3.61	
10/35 nominal			
Heating capacity (P _H)	kW	4.30	
Supplied power (P _E)	kW	0.66	
COP		6.49	
10/45 nominal			
Heating capacity (P _H)	kW	3.98	
Supplied power (P _E)	kW	0.83	
COP		4.79	
SCOP according to EN 14825			
Rated heating output (P _{designh})	kW	4	6
SCOP _{EN14825} cold climate 35 °C / 55 °C		5.5 / 4.1	
SCOP _{EN14825} average climate, 35 °C / 55 °C		5.2 / 4.0	
Energy rating, average climate			
The product's room heating efficiency class 35 °C / 55 °C ¹		A+++ / A+++	
The system's room heating efficiency class 35 °C / 55 °C ²		A+++ / A+++	
Efficiency class hot water / charging profile ³		A / XL	
Noise			
Sound power level (L _{WA}) _{acc} to EN 12102 at 0/35	dB(A)	36 – 43	
Sound pressure level (L _{PA}) _{calculated values according to EN ISO 11203 at 0/35 and 1m range}	dB(A)	21 – 28	
Electrical data			
Output, Brine pump	W	10 – 87	
Output, Heating medium pump	W	2 – 63	
Enclosure class		IP21	
Refrigerant circuit			
Type of refrigerant		R407C	
GWP refrigerant		1,774	
Volume	kg	1.16	
CO ₂ equivalent	ton	2.06	
Cut-out value pressure switch HP / LP	MPa (bar)	3.2 (32) / 0.15 (1.5)	
Difference pressure switch HP / LP	MPa (bar)	-0.7 (-7) / 0.15 (1.5)	
Brine circuit			
Min/max system pressure brine	MPa (bar)	0.05 (0.5) / 0.45 (4.5)	
Nominal flow	l/s	0.18	
Flow at P _{designh}	l/s	0.2	0.29
Max external avail. press at nom flow	kPa	64	
Max external available press at P _{designh}	kPa	62	52
Min/Max incoming Brine temp	°C	see diagram	
Min. outgoing brine temp.	°C	-12	

		F1253-4		F1253-6	
Heating medium circuit					
Min/Max system pressure heating medium	MPa (bar)	0.05 (0.5) / 0.45 (4.5)			
Nominal flow	l/s	0.08			
Flow at Pdesignh	l/s	0.11	0.16		
Max external avail. press at nom flow	kPa	69			
Max external available press at Pdesignh	kPa	68			
Min/max HM-temp	°C	see diagram			
Pipe connections					
Brine ext diam. CU pipe	mm	28			
Heating medium ext diam. CU pipes	mm	22			
Hot water connection external diam	mm	22			
Cold water connection external diam	mm	22			
Water heater					
Volume water heater	l	approx. 180			
Max pressure in water heater	MPa (bar)	1.0 (10)			
Hot water heating capacity (comfort mode Normal) according to EN16147					
Amount of hot water (40 °C)		245			
COP _{DHW} (load profile XL)		2.6			
Compressor oil					
Oil type		POE			
Volume	l	0.68			
Dimensions and weight					
Width	mm	600			
Depth	mm	620			
Height	mm	1800			
Required ceiling height ⁴	mm	1950			
Corrosion protection ⁵		Rf	E	Rf	E
Weight complete heat pump	kg	200	235	200	235
Weight only cooling module	kg	90			
Part no, 1x230 V		065 872	-	065 871	-
Part no, 3x400 V		065 741	065 742	065 750	065 751

¹ Scale for the product's efficiency class room heating: A+++ to D.

² Scale for the system's efficiency class room heating: A+++ to G. Reported efficiency for the system takes the product's temperature regulator into account.

³ Scale for efficiency class hot water: A+ to F.

⁴ With feet removed, the required ceiling height is approx. 1,930 mm.

⁵ Rf: stainless steel, E: enamel.

WORKING RANGE HEAT PUMP, COMPRESSOR OPERATION

The compressor provides a supply temperature up to 65 °C, at 0 °C incoming brine temperature, the remainder (up to 70°C) is obtained using the additional heat.

This diagram shows the entire working range for F1253-4 and under 75 % for F1253-6.

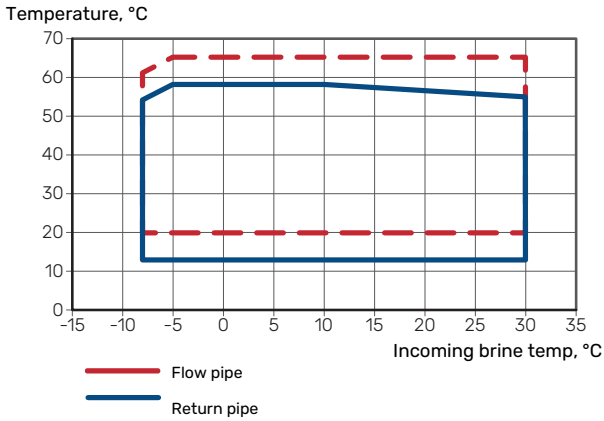

This diagram shows the working range above 75 % for F1253-6.

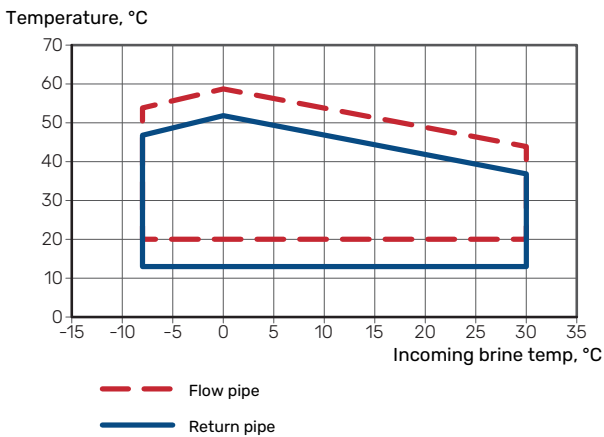

NOTE!

For operation of F1253 above 75 % compressor speed, unlocking is required in menu 5.1.24. This can produce a louder noise level than the value stated in the technical specifications.

DIAGRAM, DIMENSIONING COMPRESSOR SPEED

Heating mode 35 °C

Use this diagram to dimension the heat pump. The percentages show approximate compressor speed.

F1253-4

Specified heating output, kW

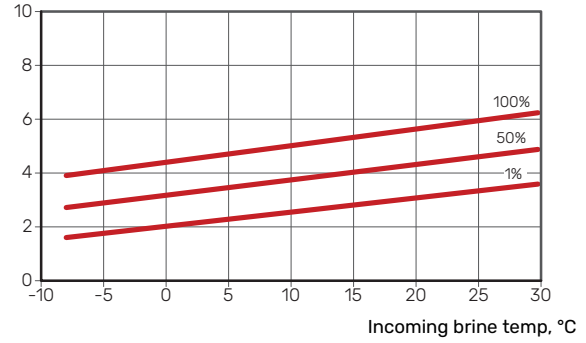

F1253-6

Specified heating output, kW

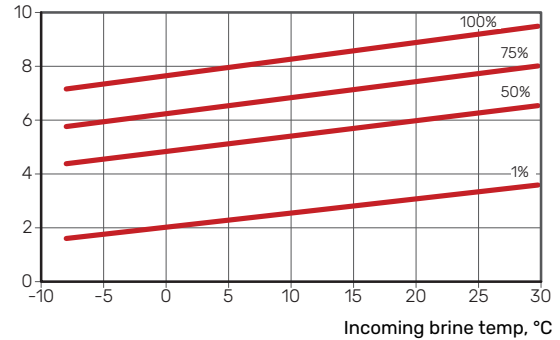

Cooling mode (Accessory required)



NOTE!

To dimension heating dump, see the diagram for heating operation.

Supply temperature, heating medium 35 °C

F1253-4

Specified cooling output, kW

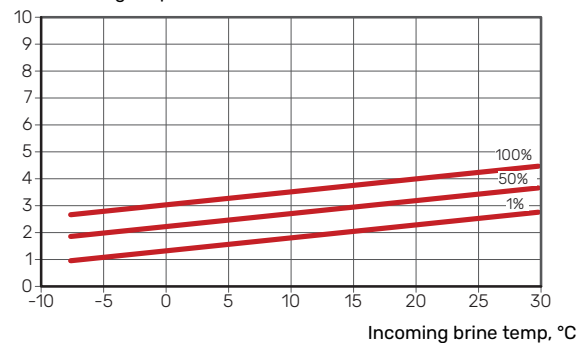

F1253-6

Specified cooling output, kW

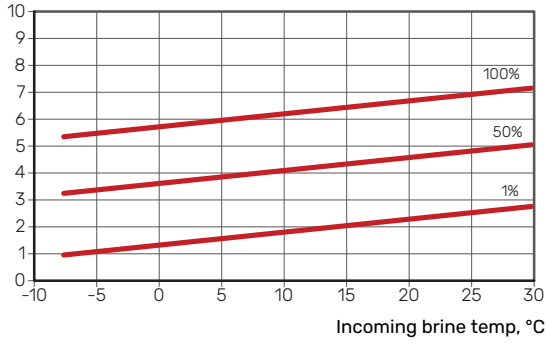

Supply temperature, heating medium 50 °°C

F1253-4

Specified cooling output, kW

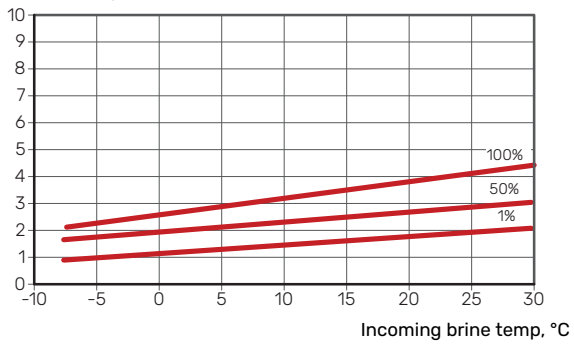

F1253-6

Specified cooling output, kW

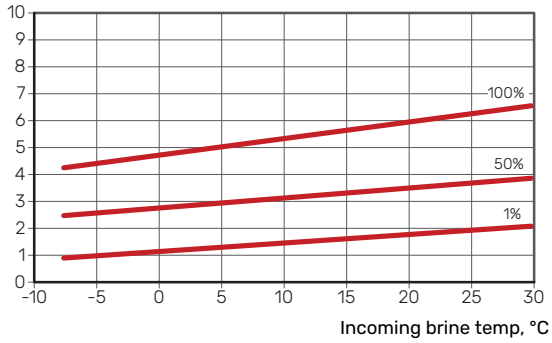

Energy labelling

INFORMATION SHEET

Supplier		NIBE AB	
Model		F1253-4 1x230V	F1253-6 1x230V
Temperature application	°C	35 / 55	35 / 55
Declared load profile for water heating		XL	XL
Seasonal space heating energy efficiency class, average climate		A+++ / A+++	A+++ / A+++
Water heating energy efficiency class, average climate		A	A
Rated heat output (P_{designh}), average climate	kW	4	6
Annual energy consumption space heating, average climate	kWh	1,696 / 2,248	2,188 / 2,875
Annual energy consumption water heating, average climate	kWh	1,642	1,642
Seasonal space heating energy efficiency, average climate	%	202 / 150	200 / 150
Water heating energy efficiency, average climate	%	102	102
Sound power level L_{WA} indoors	dB	42	42
Rated heat output (P_{designh}), cold climate	kW	4	6
Rated heat output (P_{designh}), warm climate	kW	4	6
Annual energy consumption space heating, cold climate	kWh	1,930 / 2,623	2,481 / 3,287
Annual energy consumption water heating, cold climate	kWh	1,642	1,642
Annual energy consumption space heating, warm climate	kWh	1,109 / 1,470	1,408 / 1,852
Annual energy consumption water heating, warm climate	kWh	1,642	1,642
Seasonal space heating energy efficiency, cold climate	%	212 / 154	211 / 157
Water heating energy efficiency, cold climate	%	102	102
Seasonal space heating energy efficiency, warm climate	%	199 / 148	201 / 151
Water heating energy efficiency, warm climate	%	102	102
Sound power level L_{WA} outdoors	dB	-	-

Compressor motor is exempted from EU 2019/1781 due to that motors completely integrated into compressor and energy performance cannot be tested independently from the product.

Supplier	NIBE AB		
Model		F1253-4 3x400V	F1253-6 3x400V
Temperature application	°C	35 / 55	35 / 55
Declared load profile for water heating		XL	XL
Seasonal space heating energy efficiency class, average climate		A+++ / A+++	A+++ / A+++
Water heating energy efficiency class, average climate		A	A
Rated heat output (P _{designh}), average climate	kW	4	6
Annual energy consumption space heating, average climate	kWh	1,696 / 2,248	2,188 / 2,875
Annual energy consumption water heating, average climate	kWh	1,642	1,642
Seasonal space heating energy efficiency, average climate	%	202 / 150	200 / 150
Water heating energy efficiency, average climate	%	102	102
Sound power level L _{WA} indoors	dB	42	42
Rated heat output (P _{designh}), cold climate	kW	4	6
Rated heat output (P _{designh}), warm climate	kW	4	6
Annual energy consumption space heating, cold climate	kWh	1,930 / 2,623	2,481 / 3,287
Annual energy consumption water heating, cold climate	kWh	1,642	1,642
Annual energy consumption space heating, warm climate	kWh	1,109 / 1,470	1,408 / 1,852
Annual energy consumption water heating, warm climate	kWh	1,642	1,642
Seasonal space heating energy efficiency, cold climate	%	212 / 154	211 / 157
Water heating energy efficiency, cold climate	%	102	102
Seasonal space heating energy efficiency, warm climate	%	199 / 148	201 / 151
Water heating energy efficiency, warm climate	%	102	102
Sound power level L _{WA} outdoors	dB	-	-

Compressor motor is exempted from EU 2019/1781 due to that motors completely integrated into compressor and energy performance cannot be tested independently from the product.

DATA FOR ENERGY EFFICIENCY OF THE PACKAGE

Model		F1253-4 1x230V	F1253-6 1x230V
Temperature application	°C	35 / 55	35 / 55
Controller, class		VI	
Controller, contribution to efficiency	%	4	
Seasonal space heating energy efficiency of the package, average climate	%	204 / 154	204 / 154
Seasonal space heating energy efficiency class of the package, average climate		A+++	A+++
Seasonal space heating energy efficiency of the package, cold climate	%	215 / 161	215 / 161
Seasonal space heating energy efficiency of the package, warm climate	%	205 / 155	205 / 155

Model		F1253-4 3x400V	F1253-6 3x400V
Temperature application	°C	35 / 55	35 / 55
Controller, class		VI	
Controller, contribution to efficiency	%	4	
Seasonal space heating energy efficiency of the package, average climate	%	204 / 154	204 / 154
Seasonal space heating energy efficiency class of the package, average climate		A+++	A+++
Seasonal space heating energy efficiency of the package, cold climate	%	215 / 161	215 / 161
Seasonal space heating energy efficiency of the package, warm climate	%	205 / 155	205 / 155

The reported efficiency of the package also takes the controller into account. If an external supplementary boiler or solar heating is added to the package, the overall efficiency of the package should be recalculated.

TECHNICAL DOCUMENTATION

Model		F1253-4 1x230V					
Type of heat pump	<input type="checkbox"/> Air-water <input type="checkbox"/> Exhaust-water <input checked="" type="checkbox"/> Brine-water <input type="checkbox"/> Water-water						
Low-temperature heat pump	<input type="checkbox"/> Yes <input checked="" type="checkbox"/> No						
Integrated immersion heater for additional heat	<input checked="" type="checkbox"/> Yes <input type="checkbox"/> No						
Heat pump combination heater	<input checked="" type="checkbox"/> Yes <input type="checkbox"/> No						
Climate	<input checked="" type="checkbox"/> Average <input type="checkbox"/> Cold <input type="checkbox"/> Warm						
Temperature application	<input checked="" type="checkbox"/> Medium (55°C) <input type="checkbox"/> Low (35°C)						
Applied standards	EN-14825 & EN-16147						
Rated heat output	Prated	4.3	kW	Seasonal space heating energy efficiency	η_s	150	%
Declared capacity for space heating at part load and at outdoor temperature T_j				Declared coefficient of performance for space heating at part load and at outdoor temperature T_j			
$T_j = -7\text{ °C}$	Pdh	3.9	kW	$T_j = -7\text{ °C}$	COPd	3.13	-
$T_j = +2\text{ °C}$	Pdh	2.4	kW	$T_j = +2\text{ °C}$	COPd	4.03	-
$T_j = +7\text{ °C}$	Pdh	1.6	kW	$T_j = +7\text{ °C}$	COPd	4.53	-
$T_j = +12\text{ °C}$	Pdh	1.2	kW	$T_j = +12\text{ °C}$	COPd	4.66	-
$T_j = \text{biv}$	Pdh	3.8	kW	$T_j = \text{biv}$	COPd	2.95	-
$T_j = \text{TOL}$	Pdh	3.8	kW	$T_j = \text{TOL}$	COPd	2.95	-
$T_j = -15\text{ °C}$ (if TOL < -20 °C)	Pdh		kW	$T_j = -15\text{ °C}$ (if TOL < -20 °C)	COPd		-
Bivalent temperature	T_{biv}	-9	°C	Min. outdoor air temperature	TOL	-10	°C
Cycling interval capacity	P _{cy}		kW	Cycling interval efficiency	COP _{cy}		-
Degradation coefficient	Cdh	1.0	-	Max supply temperature	WTOL	65	°C
<i>Power consumption in modes other than active mode</i>				<i>Additional heat</i>			
Off mode	P _{OFF}	0.002	kW	Rated heat output	P _{sup}	0.5	kW
Thermostat-off mode	P _{TO}	0.002	kW				
Standby mode	P _{SB}	0.002	kW	Type of energy input	Electric		
Crankcase heater mode	P _{CK}	0.009	kW				
<i>Other items</i>							
Capacity control	Variable			Rated airflow (air-water)			m ³ /h
Sound power level, indoors/outdoors	L _{WA}	42 / -	dB	Nominal heating medium flow			m ³ /h
Annual energy consumption	Q _{HE}	2,248	kWh	Brine flow brine-water or water-water heat pumps		0.68	m ³ /h
<i>For heat pump combination heater</i>							
Declared load profile for water heating	XL			Water heating energy efficiency	η_{wh}	102	%
Daily energy consumption	Q _{elec}	7.48	kWh	Daily fuel consumption	Q _{fuel}		kWh
Annual energy consumption	AEC	1,642	kWh	Annual fuel consumption	AFC		GJ
Contact information	NIBE Energy Systems - Box 14 - Hannabadvägen 5 - 285 21 Markaryd - Sweden						

Model		F1253-6 1x230V					
Type of heat pump	<input type="checkbox"/> Air-water <input type="checkbox"/> Exhaust-water <input checked="" type="checkbox"/> Brine-water <input type="checkbox"/> Water-water						
Low-temperature heat pump	<input type="checkbox"/> Yes <input checked="" type="checkbox"/> No						
Integrated immersion heater for additional heat	<input checked="" type="checkbox"/> Yes <input type="checkbox"/> No						
Heat pump combination heater	<input checked="" type="checkbox"/> Yes <input type="checkbox"/> No						
Climate	<input checked="" type="checkbox"/> Average <input type="checkbox"/> Cold <input type="checkbox"/> Warm						
Temperature application	<input checked="" type="checkbox"/> Medium (55°C) <input type="checkbox"/> Low (35°C)						
Applied standards	EN-14825 & EN-16147						
Rated heat output	Prated	5.5	kW	Seasonal space heating energy efficiency	η_s	150	%
Declared capacity for space heating at part load and at outdoor temperature T_j				Declared coefficient of performance for space heating at part load and at outdoor temperature T_j			
$T_j = -7\text{ °C}$	Pdh	5.0	kW	$T_j = -7\text{ °C}$	COPd	3.06	-
$T_j = +2\text{ °C}$	Pdh	3.0	kW	$T_j = +2\text{ °C}$	COPd	3.97	-
$T_j = +7\text{ °C}$	Pdh	2.0	kW	$T_j = +7\text{ °C}$	COPd	4.63	-
$T_j = +12\text{ °C}$	Pdh	1.2	kW	$T_j = +12\text{ °C}$	COPd	4.86	-
$T_j = \text{biv}$	Pdh	5.4	kW	$T_j = \text{biv}$	COPd	2.84	-
$T_j = \text{TOL}$	Pdh	5.4	kW	$T_j = \text{TOL}$	COPd	2.84	-
$T_j = -15\text{ °C}$ (if TOL < -20 °C)	Pdh		kW	$T_j = -15\text{ °C}$ (if TOL < -20 °C)	COPd		-
Bivalent temperature	T_{biv}	-10	°C	Min. outdoor air temperature	TOL	-10	°C
Cycling interval capacity	P _{cy}		kW	Cycling interval efficiency	COP _{cy}		-
Degradation coefficient	Cdh	0.99	-	Max supply temperature	WTOL	65	°C
Power consumption in modes other than active mode				Additional heat			
Off mode	P _{OFF}	0.002	kW	Rated heat output	P _{sup}	0.1	kW
Thermostat-off mode	P _{TO}	0.007	kW				
Standby mode	P _{SB}	0.007	kW	Type of energy input	Electric		
Crankcase heater mode	P _{CK}	0.009	kW				
Other items							
Capacity control	Variable			Rated airflow (air-water)			m ³ /h
Sound power level, indoors/outdoors	L _{WA}	42 / -	dB	Nominal heating medium flow			m ³ /h
Annual energy consumption	Q _{HE}	2,875	kWh	Brine flow brine-water or water-water heat pumps		0.68	m ³ /h
For heat pump combination heater							
Declared load profile for water heating	XL			Water heating energy efficiency	η_{wh}	102	%
Daily energy consumption	Q _{elec}	7.73	kWh	Daily fuel consumption	Q _{fuel}		kWh
Annual energy consumption	AEC	1,642	kWh	Annual fuel consumption	AFC		GJ
Contact information	NIBE Energy Systems – Box 14 – Hannabadsvägen 5 – 285 21 Markaryd – Sweden						

Model		F1253-4 3x400V					
Type of heat pump	<input type="checkbox"/> Air-water <input type="checkbox"/> Exhaust-water <input checked="" type="checkbox"/> Brine-water <input type="checkbox"/> Water-water						
Low-temperature heat pump	<input type="checkbox"/> Yes <input checked="" type="checkbox"/> No						
Integrated immersion heater for additional heat	<input checked="" type="checkbox"/> Yes <input type="checkbox"/> No						
Heat pump combination heater	<input checked="" type="checkbox"/> Yes <input type="checkbox"/> No						
Climate	<input checked="" type="checkbox"/> Average <input type="checkbox"/> Cold <input type="checkbox"/> Warm						
Temperature application	<input checked="" type="checkbox"/> Medium (55°C) <input type="checkbox"/> Low (35°C)						
Applied standards	EN-14825 & EN-16147						
Rated heat output	Prated	4,3	kW	Seasonal space heating energy efficiency	η_s	150	%
Declared capacity for space heating at part load and at outdoor temperature T_j				Declared coefficient of performance for space heating at part load and at outdoor temperature T_j			
$T_j = -7\text{ °C}$	Pdh	3.9	kW	$T_j = -7\text{ °C}$	COPd	3.13	-
$T_j = +2\text{ °C}$	Pdh	2.4	kW	$T_j = +2\text{ °C}$	COPd	4.03	-
$T_j = +7\text{ °C}$	Pdh	1.6	kW	$T_j = +7\text{ °C}$	COPd	4.53	-
$T_j = +12\text{ °C}$	Pdh	1.2	kW	$T_j = +12\text{ °C}$	COPd	4.66	-
$T_j = \text{biv}$	Pdh	3.8	kW	$T_j = \text{biv}$	COPd	2.95	-
$T_j = \text{TOL}$	Pdh	3.8	kW	$T_j = \text{TOL}$	COPd	2.95	-
$T_j = -15\text{ °C}$ (if TOL < -20 °C)	Pdh		kW	$T_j = -15\text{ °C}$ (if TOL < -20 °C)	COPd		-
Bivalent temperature	T_{biv}	-9	°C	Min. outdoor air temperature	TOL	-10	°C
Cycling interval capacity	P _{cy}		kW	Cycling interval efficiency	COP _{cy}		-
Degradation coefficient	Cdh	1.0	-	Max supply temperature	WTOL	65	°C
Power consumption in modes other than active mode				Additional heat			
Off mode	P _{OFF}	0.002	kW	Rated heat output	P _{sup}	0.5	kW
Thermostat-off mode	P _{TO}	0.002	kW				
Standby mode	P _{SB}	0.002	kW	Type of energy input	Electric		
Crankcase heater mode	P _{CK}	0.009	kW				
Other items							
Capacity control	Variable			Rated airflow (air-water)			
Sound power level, indoors/outdoors	L _{WA}	42 / -	dB	Nominal heating medium flow			
Annual energy consumption	Q _{HE}	2,248	kWh	Brine flow brine-water or water-water heat pumps		0.68	m ³ /h
For heat pump combination heater							
Declared load profile for water heating	XL			Water heating energy efficiency	η_{wh}	102	%
Daily energy consumption	Q _{elec}	7.48	kWh	Daily fuel consumption	Q _{fuel}		kWh
Annual energy consumption	AEC	1,642	kWh	Annual fuel consumption	AFC		GJ
Contact information	NIBE Energy Systems – Box 14 – Hannabadsvägen 5 – 285 21 Markaryd – Sweden						

Model		F1253-6 3x400V						
Type of heat pump	<input type="checkbox"/> Air-water <input type="checkbox"/> Exhaust-water <input checked="" type="checkbox"/> Brine-water <input type="checkbox"/> Water-water							
Low-temperature heat pump	<input type="checkbox"/> Yes <input checked="" type="checkbox"/> No							
Integrated immersion heater for additional heat	<input checked="" type="checkbox"/> Yes <input type="checkbox"/> No							
Heat pump combination heater	<input checked="" type="checkbox"/> Yes <input type="checkbox"/> No							
Climate	<input checked="" type="checkbox"/> Average <input type="checkbox"/> Cold <input type="checkbox"/> Warm							
Temperature application	<input checked="" type="checkbox"/> Medium (55°C) <input type="checkbox"/> Low (35°C)							
Applied standards	EN-14825 & EN-16147							
Rated heat output	Prated	5.5	kW	Seasonal space heating energy efficiency	η_s	150	%	
Declared capacity for space heating at part load and at outdoor temperature T_j				Declared coefficient of performance for space heating at part load and at outdoor temperature T_j				
$T_j = -7\text{ °C}$	Pdh	5.0	kW	$T_j = -7\text{ °C}$	COPd	3.06	-	
$T_j = +2\text{ °C}$	Pdh	3.0	kW	$T_j = +2\text{ °C}$	COPd	3.97	-	
$T_j = +7\text{ °C}$	Pdh	2.0	kW	$T_j = +7\text{ °C}$	COPd	4.63	-	
$T_j = +12\text{ °C}$	Pdh	1.2	kW	$T_j = +12\text{ °C}$	COPd	4.86	-	
$T_j = \text{biv}$	Pdh	5.4	kW	$T_j = \text{biv}$	COPd	2.84	-	
$T_j = \text{TOL}$	Pdh	5.4	kW	$T_j = \text{TOL}$	COPd	2.84	-	
$T_j = -15\text{ °C}$ (if TOL < -20 °C)	Pdh		kW	$T_j = -15\text{ °C}$ (if TOL < -20 °C)	COPd		-	
Bivalent temperature	T_{biv}	-10	°C	Min. outdoor air temperature	TOL	-10	°C	
Cycling interval capacity	P _{cy}		kW	Cycling interval efficiency	COP _{cy}		-	
Degradation coefficient	Cdh	0.99	-	Max supply temperature	WTOL	65	°C	
Power consumption in modes other than active mode				Additional heat				
Off mode	P _{OFF}	0.002	kW	Rated heat output	P _{sup}	0.1	kW	
Thermostat-off mode	P _{TO}	0.007	kW					
Standby mode	P _{SB}	0.007	kW	Type of energy input	Electric			
Crankcase heater mode	P _{CK}	0.009	kW					
Other items								
Capacity control	Variable			Rated airflow (air-water)			m ³ /h	
Sound power level, indoors/outdoors	L _{WA}	42 / -	dB	Nominal heating medium flow			m ³ /h	
Annual energy consumption	Q _{HE}	2,875	kWh	Brine flow brine-water or water-water heat pumps		0.68	m ³ /h	
For heat pump combination heater								
Declared load profile for water heating	XL			Water heating energy efficiency	η_{wh}	102	%	
Daily energy consumption	Q _{elec}	7.48	kWh	Daily fuel consumption	Q _{fuel}		kWh	
Annual energy consumption	AEC	1,642	kWh	Annual fuel consumption	AFC		GJ	
Contact information	NIBE Energy Systems – Box 14 – Hannabadsvägen 5 – 285 21 Markaryd – Sweden							

Electrical circuit diagram

1X230 V 4/6 KW

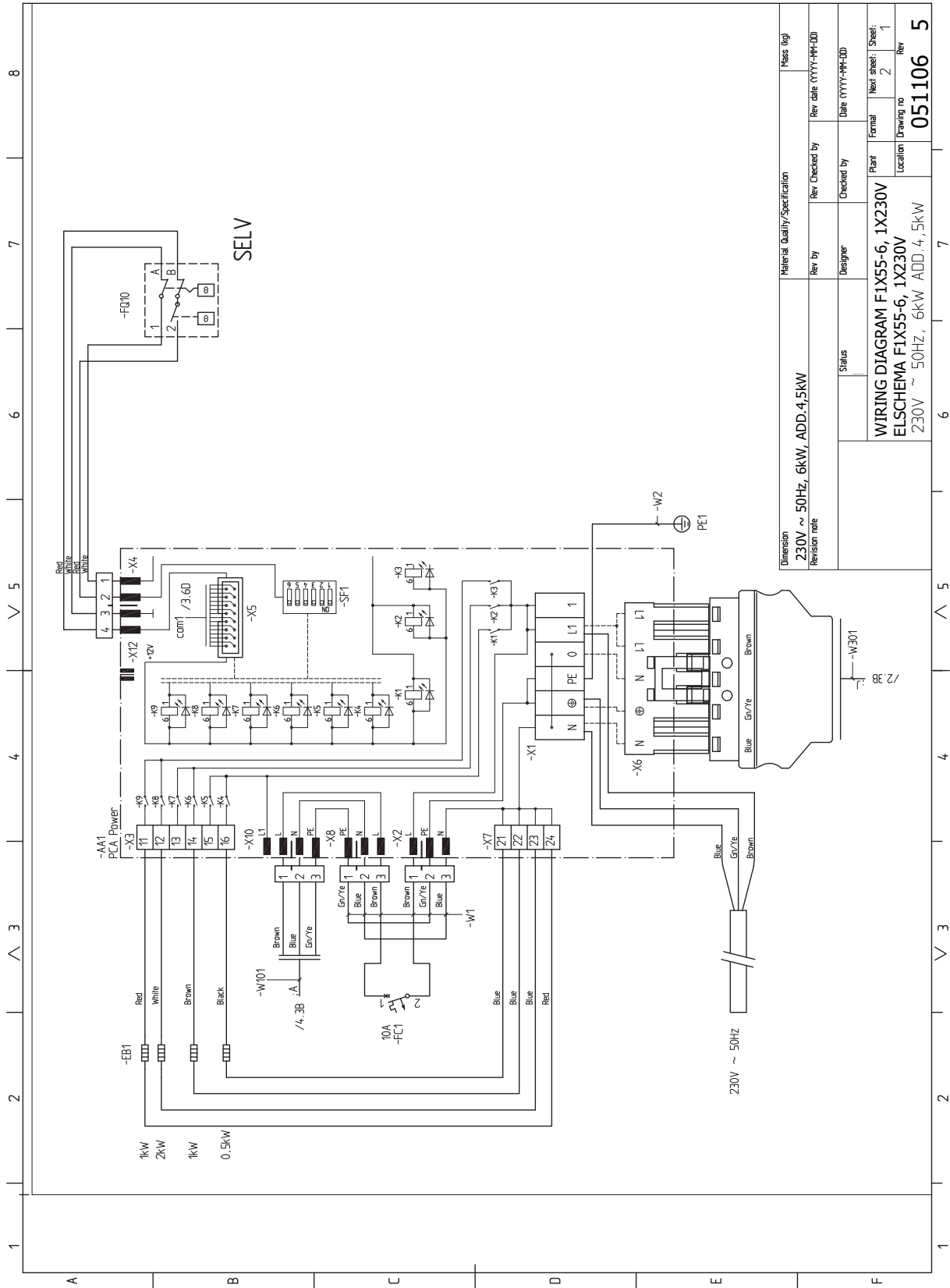

Material Quality/Specification		Mass (kg)	
Dimension	230V ~ 50Hz, 6kW, ADD: 4.5kW	Rev. table	(YYYY-MM-DD)
Revision note		Checked by	
		Designer	
		Status	
		Plant	FIX55-6, 1X230V
		Location	ELSCHEMA, FIX55-6, 1X230V
		Formal Drawing no	051106
		Next Sheet	1
		Rev	5

1 2 3 4 5 6 7 8

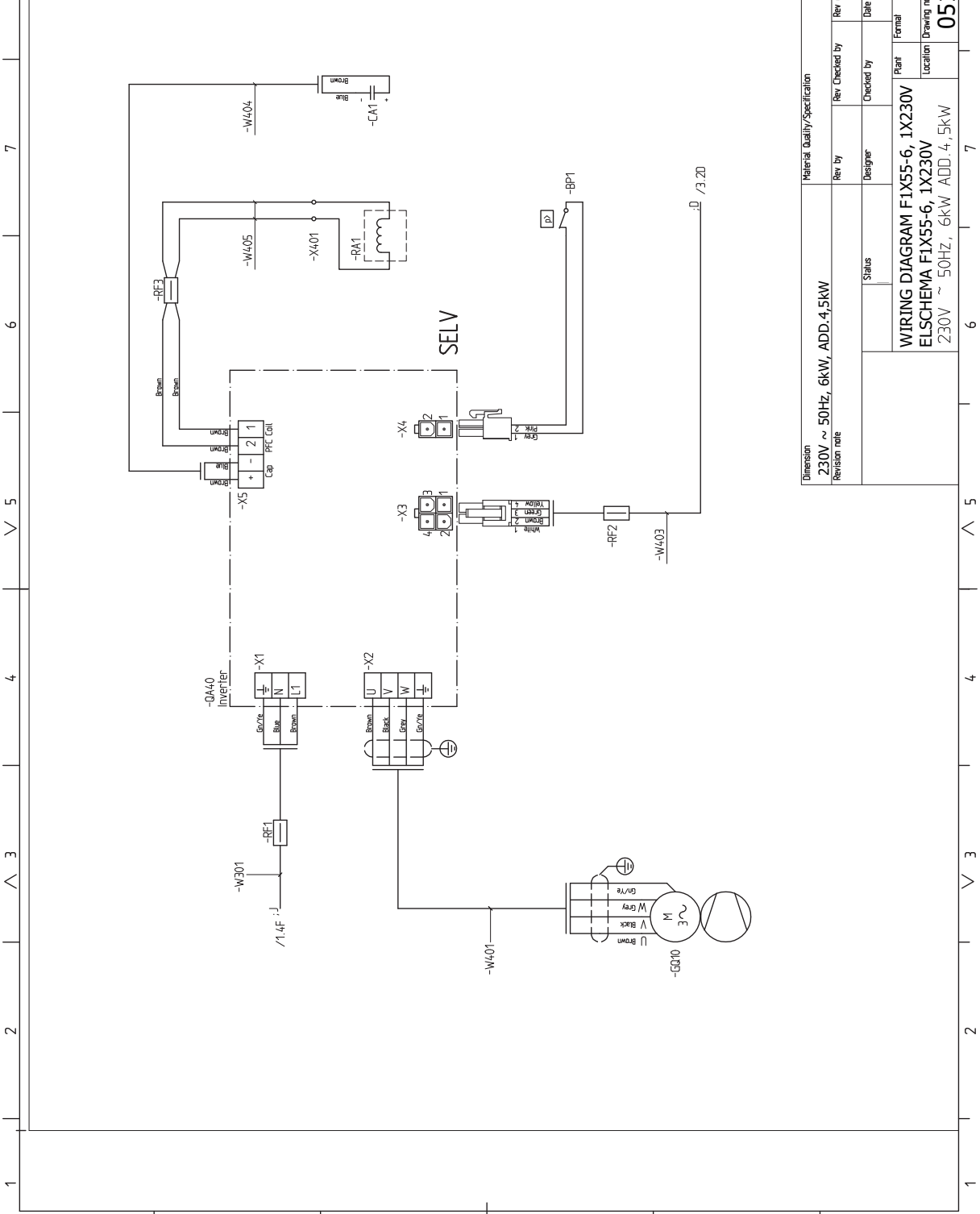

A B C D E F

1 2 3 4 5 6 7 8

Material Quality/Specification		Mass (kg)	
Dimension	230V ~ 50Hz, 6kW, ADD. 4.5kW	Rev by	Rev date (YYYY-MM-DD)
Revision note		Designer	Date (YYYY-MM-DD)
		Status	Plant
			Formal
			Next sheet: 3
			Sheet: 2
		Location	Drawing no
			051106
			Rev
			5

WIRING DIAGRAM FIX55-6, 1X230V
 ELSCHEMA FIX55-6, 1X230V
 230V ~ 50HZ, 6kW ADD. 4,5kW

1 2 3 4 5 6 7 8

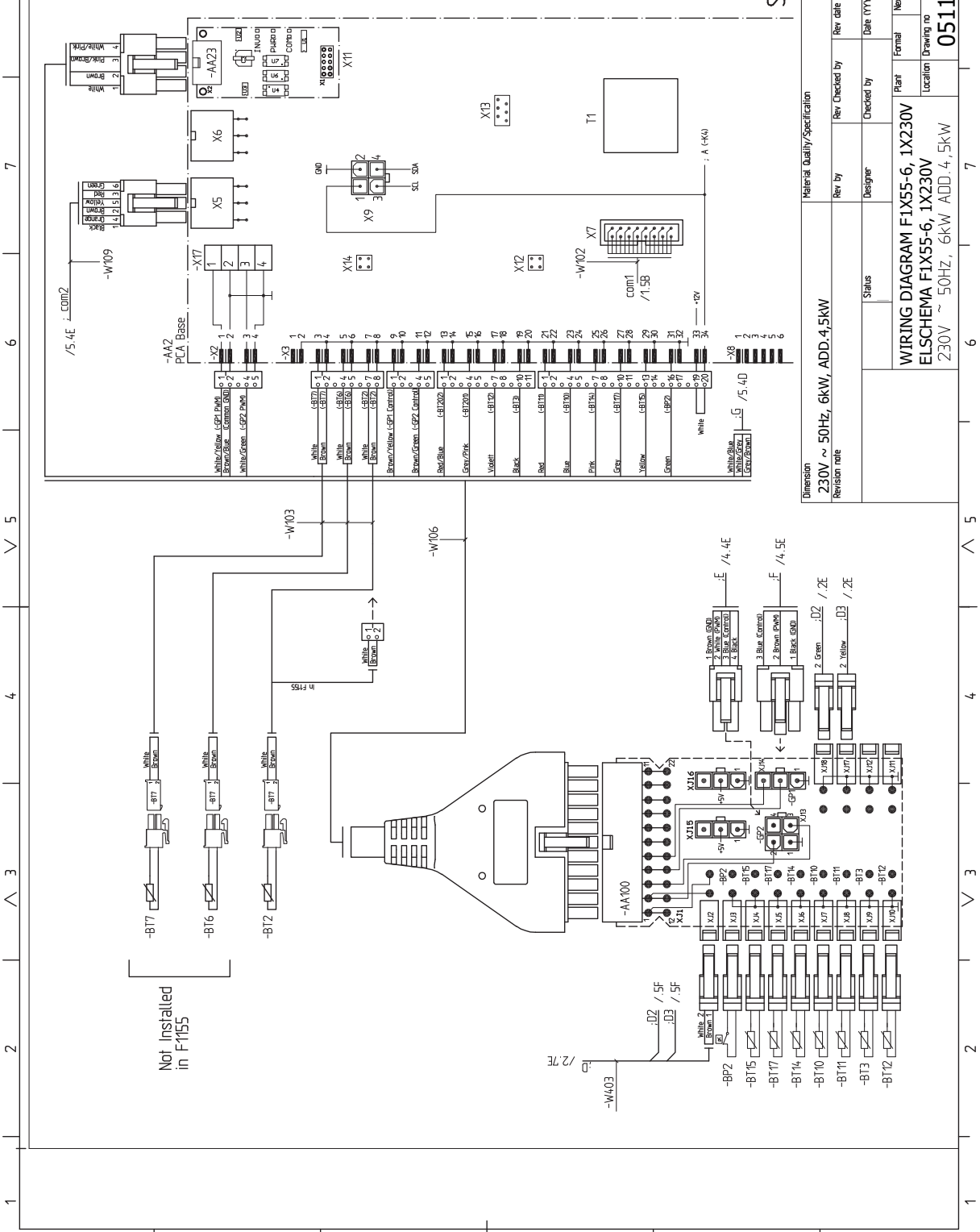

SELV

Dimension	230V ~ 50Hz, 6kW, ADD. 4.5kW		Material Quality/Specification	Mass (kg)
Revision note	Rev. by	Rev. Checked by	Rev. date (YYYY-MM-DD)	
	Status	Designer	Checked by	Date (YYYY-MM-DD)
				Plant
				Formal
				Next sheet: 3
				Drawing no
				051106
				Rev
				5

WIRING DIAGRAM FIX55-6, 1X230V
 ELSCHHEMA FIX55-6, 1X230V
 230V ~ 50HZ, 6kW ADD. 4.5kW

1 2 3 4 5 6 7 8

A B C D E F

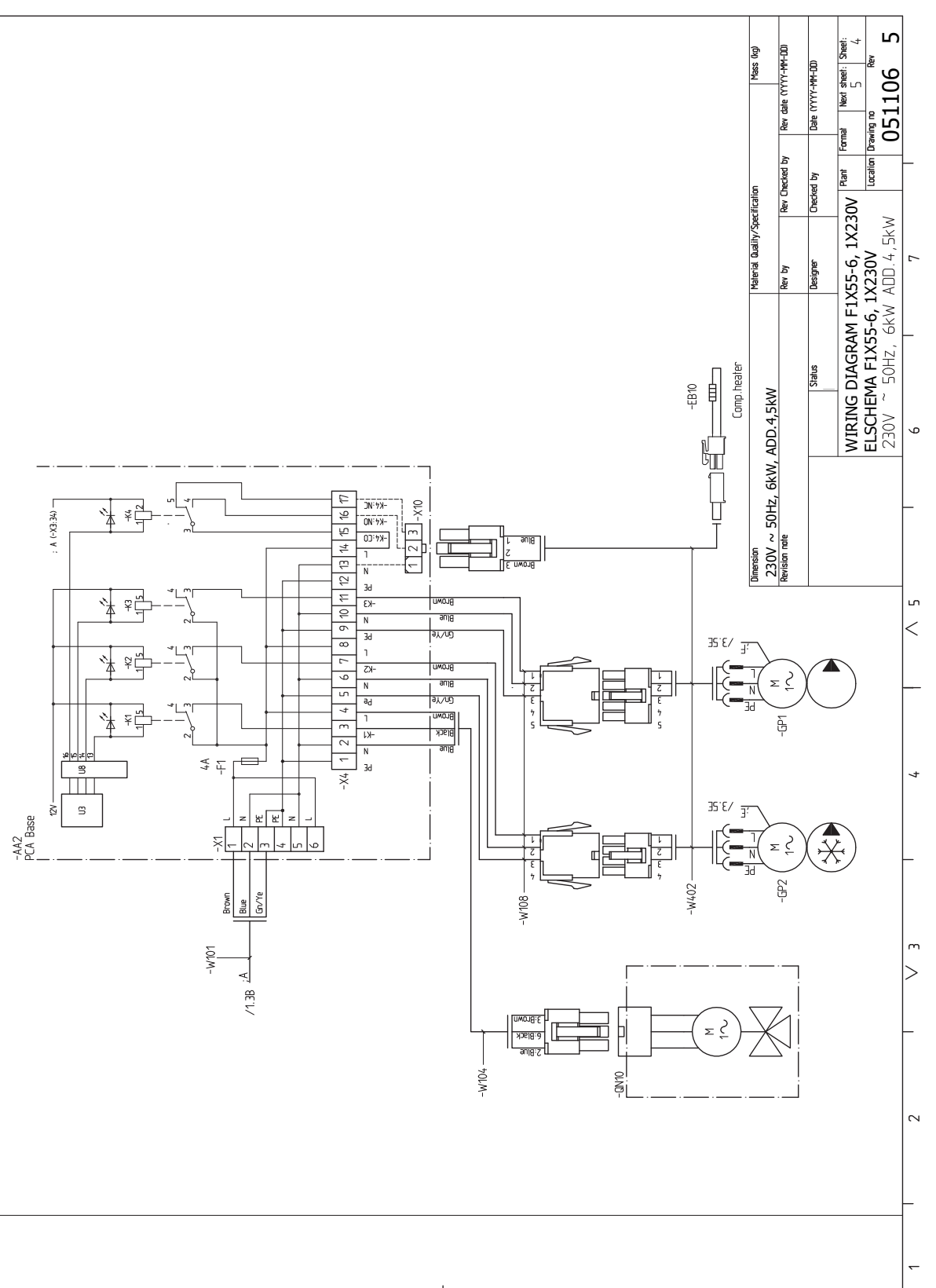

Material Quality/Specification		Mass (kg)	
Dimension	230V ~ 50Hz, 6kW, ADD. 4.5kW	Rev by	Rev date (YYYY-MM-DD)
Revision note		Designer	Checked by
		Status	Date (YYYY-MM-DD)
WIRING DIAGRAM FIX55-6, 1X230V		Plant	Formal
ELSCHEMA FIX55-6, 1X230V		Location	Next sheet: Sheet
230V ~ 50Hz, 6kW ADD. 4.5kW		Location	Drawing no
		Rev	Rev

1 2 3 4 5 6 7 8

A B C D E F

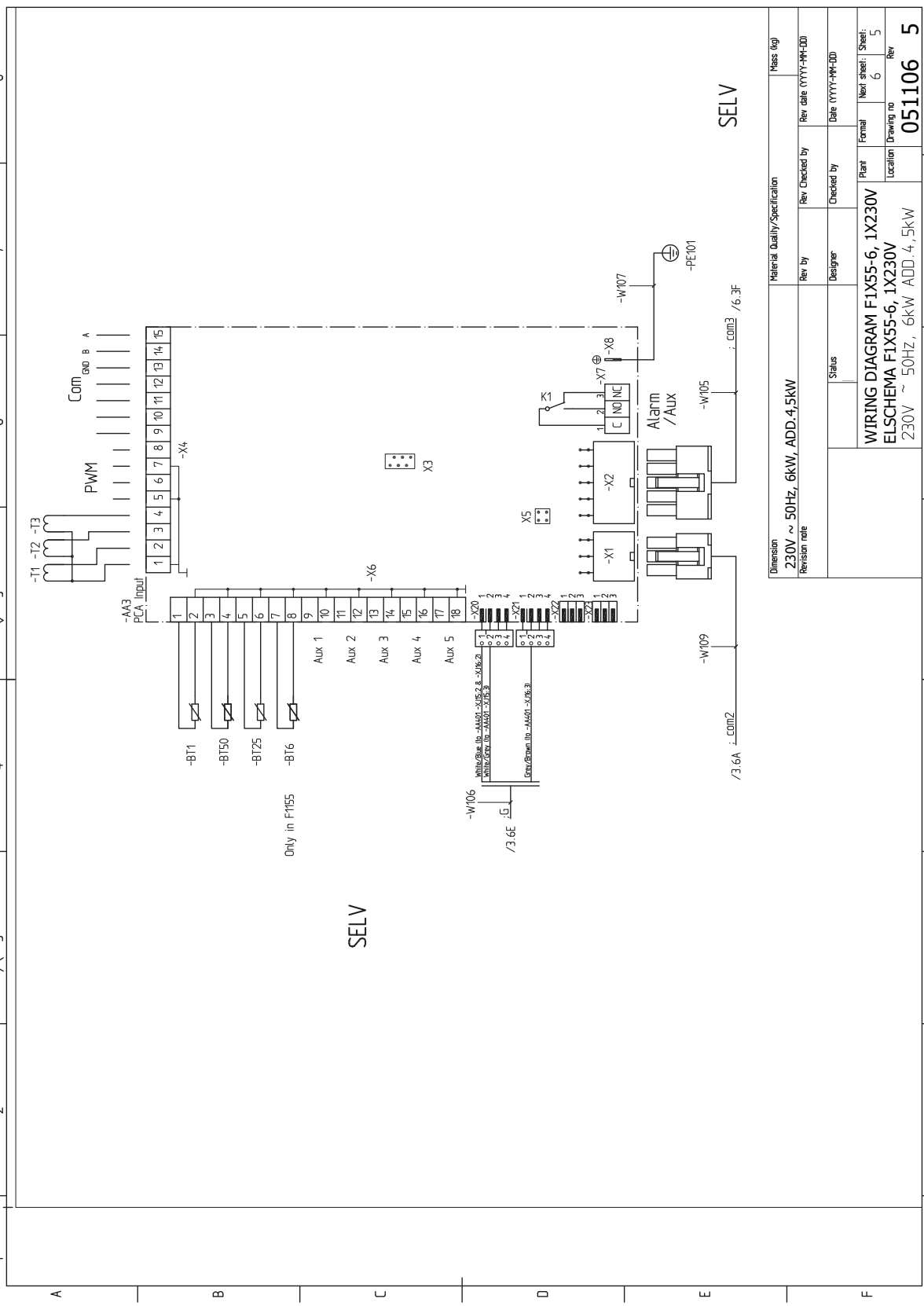

SELV

Material Quality/Specification		Mass (kg)	
Dimension	Revision note	Rev by	Rev date (YYYY-MM-DD)
230V ~ 50Hz, 6kW, ADD. 4.5kW		Designer	Date (YYYY-MM-DD)
Status		Checked by	Plant
WIRING DIAGRAM FIX55-6, 1X230V		Formal	Next sheet: Sheet: 5
ELSCHEMA FIX55-6, 1X230V		Location	Drawing no
230V ~ 50Hz, 6kW ADD. 4.5kW		051106	
		Rev 5	

1 2 3 4 5 6 7 8

1 2 3 4 5 6 7 8

-AA4
PCA Display Unit

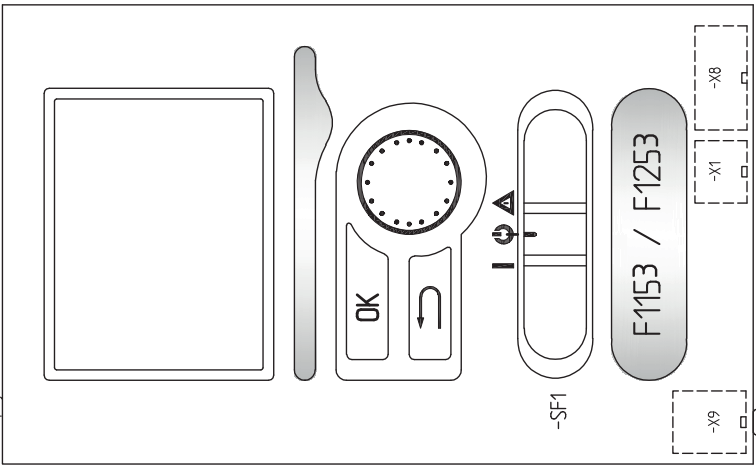

-SF1

F1153 / F1253

SELV

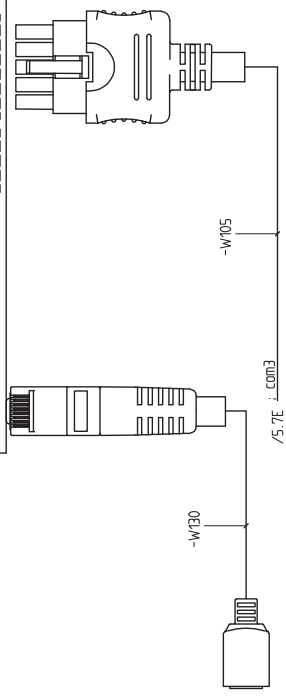

Material Quality/Specification		Mass (kg)	
Dimension	230V ~ 50Hz, 6kW, ADD. 4.5kW	Rev. Checked by	Rev. date (YYYY-MM-DD)
Revision note		Designer	Date (YYYY-MM-DD)
		Checked by	Plant
		Status	Formal
			Next sheet: Sheet: 6
			Location
			Drawing no
			Rev
			051106
			5

WIRING DIAGRAM FIX55-6, 1X230V
 ELSCHEMA FIX55-6, 1X230V
 230V ~ 50HZ, 6kW ADD. 4,5kW

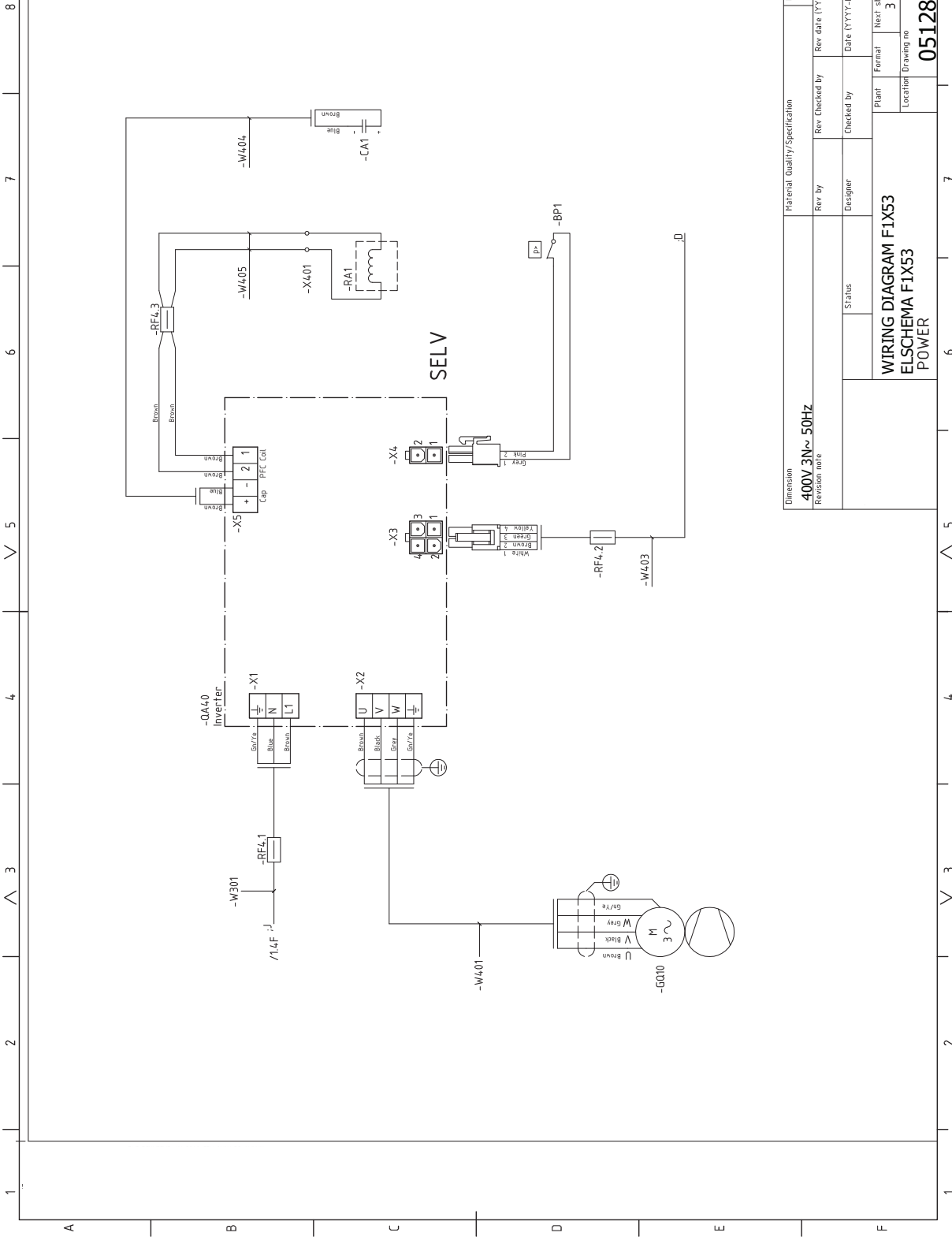

Dimension		Material Quality/Specification		Mass (kg)	
400V 3N~50Hz		Rev by		Rev date (YYYY-MM-DD)	
Revision note		Designer		Date (YYYY-MM-DD)	
Status		Checked by		Plant	
WIRING DIAGRAM FIX53		Formal		Next sheet	
ELSCHEMA FIX53		Drawing no		3	
POWER		Rev		2	
		Drawing no		051286	
		Rev		2	

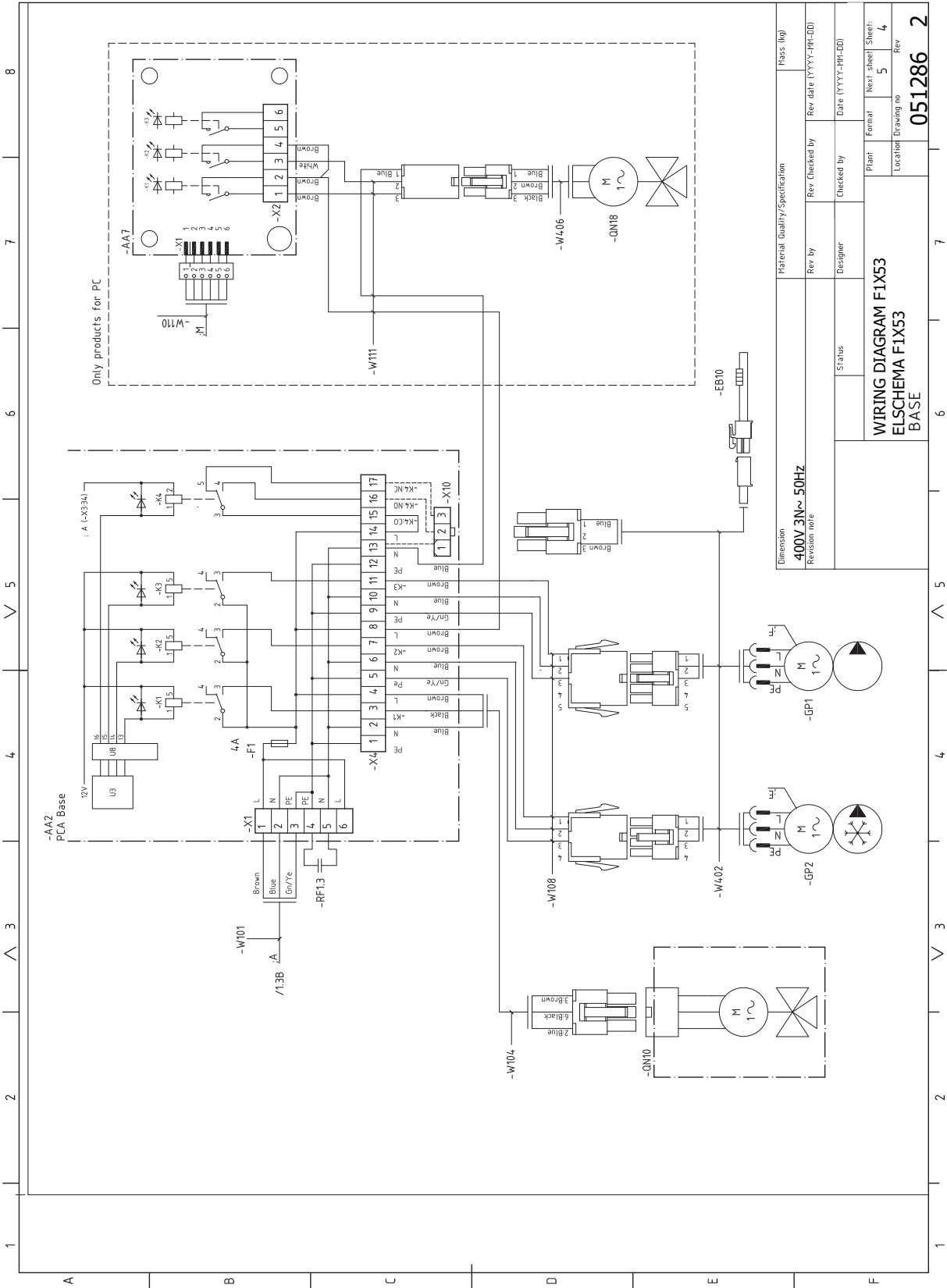

Dimension 400V 3N~50Hz Revision note		Material Quality/Specification		Mass (kg)	
Rev by	Rev checked by	Rev date (YYYY-MM-DD)	Checked by	Date (YYYY-MM-DD)	
Status			Designer	Plant	Next sheet
WIRING DIAGRAM FIX53 ELSCHEMA FIX53 BASE			Location	Drawing no	Rev
				051286	2

1 2 3 4 5 6 7 8

1 2 3 4 5 6 7

1 2 3 4 5 6 7 8

1 2 3 4 5 6 7 8

1 2 3 4 5 6 7 8

1 2 3 4 5 6 7 8

1 2 3 4 5 6 7 8

1 2 3 4 5 6 7 8

1 2 3 4 5 6 7 8

1 2 3 4 5 6 7 8

1 2 3 4 5 6 7 8

1 2 3 4 5 6 7 8

1 2 3 4 5 6 7 8

1 2 3 4 5 6 7 8

1 2 3 4 5 6 7 8

1 2 3 4 5 6 7 8

1 2 3 4 5 6 7 8

1 2 3 4 5 6 7 8

1 2 3 4 5 6 7 8

1 2 3 4 5 6 7 8

1 2 3 4 5 6 7 8

1 2 3 4 5 6 7 8

1 2 3 4 5 6 7 8

1 2 3 4 5 6 7 8

1 2 3 4 5 6 7 8

1 2 3 4 5 6 7 8

1 2 3 4 5 6 7 8

1 2 3 4 5 6 7 8

1 2 3 4 5 6 7 8

1 2 3 4 5 6 7 8

1 2 3 4 5 6 7 8

1 2 3 4 5 6 7 8

1 2 3 4 5 6 7 8

1 2 3 4 5 6 7 8

1 2 3 4 5 6 7 8

1 2 3 4 5 6 7 8

1 2 3 4 5 6 7 8

1 2 3 4 5 6 7 8

1 2 3 4 5 6 7 8

1 2 3 4 5 6 7 8

1 2 3 4 5 6 7 8

1 2 3 4 5 6 7 8

1 2 3 4 5 6 7 8

1 2 3 4 5 6 7 8

1 2 3 4 5 6 7 8

1 2 3 4 5 6 7 8

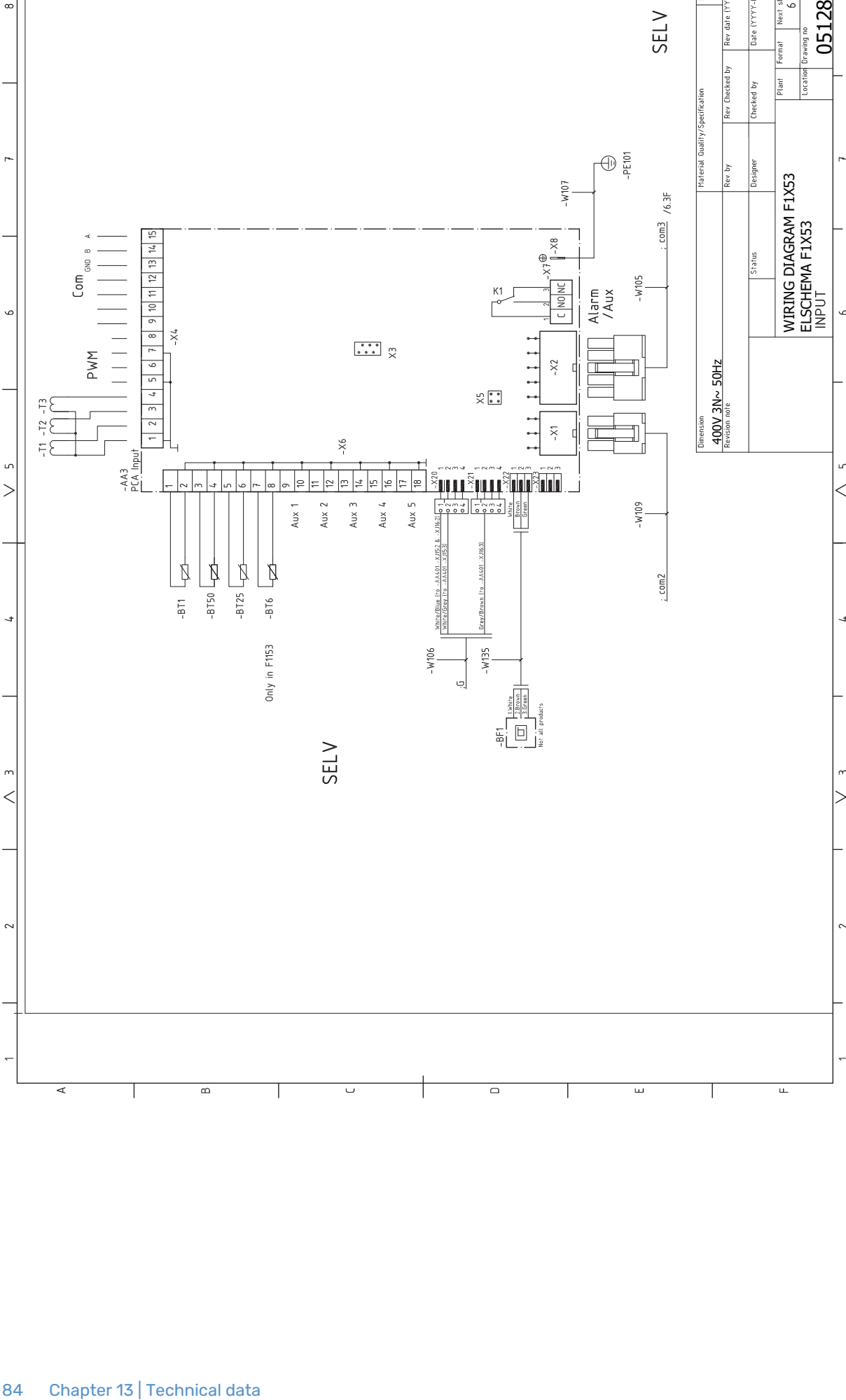

1 2 3 4 5 6 7 8

-AA4
PCA Display Unit

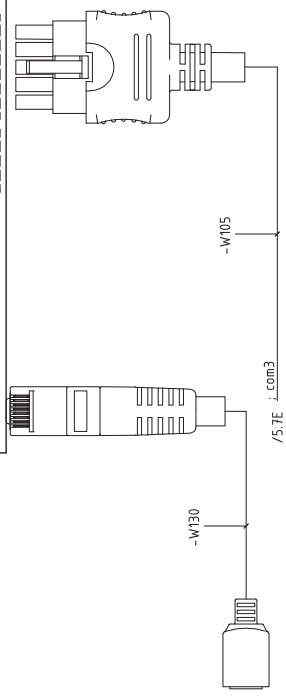
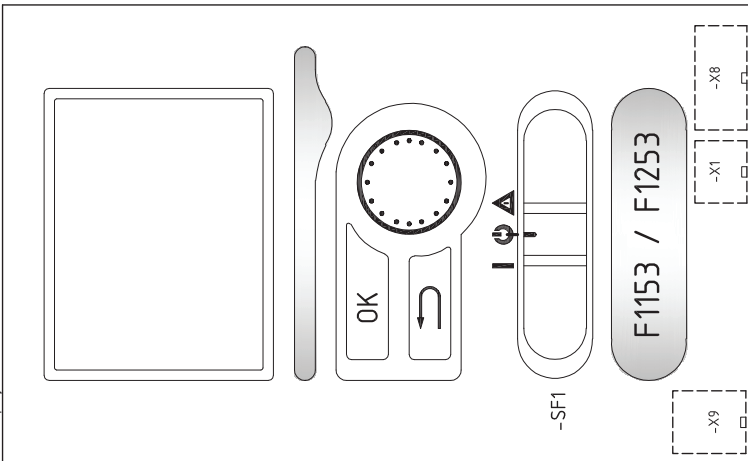

SELV

Dimension		Material Quality/Specification		Mass (kg)	
400V 3N~ 50Hz		Rev by	Rev Checked by	Rev date (YYYY-MM-DD)	
Revision note		Status	Checked by	Date (YYYY-MM-DD)	
		Designer	Plant	Formal	Next sheet
			Location	Drawing no	Rev
		WIRING DIAGRAM FIX53			051286
		ELSCHEMA FIX53			2
		DISPLAY			

Item register

- A**
 - Accessibility, electrical connection, 20
 - Accessories, 60
 - Alarm, 58
 - Assembly, 7
- B**
 - Back button, 35
 - Brine side, 17
 - Buffer vessel UKV, 18
- C**
 - Cable lock, 21
 - Climate system, 18
 - Cold and hot water, 18
 - Connecting cold and hot water, 18
 - Commissioning and adjusting, 29
 - Filling and venting, 29
 - Preparations, 29
 - Start guide, 30
 - Commissioning and adjustment
 - Setting pump speeds, 31
 - Connecting accessories, 28
 - Connecting current sensors, 25
 - Connecting external operating voltage for the control system, 22
 - Connecting the climate system, 18
 - Connections, 22
 - Control, 35, 39
 - Control - Introduction, 35
 - Control - Menus, 39
 - Control - Introduction, 35
 - Display unit, 35
 - Menu system, 35
 - Control knob, 35
 - Controlling ground water pump, 27
 - Control - Menus, 39
 - Menu 5 - SERVICE, 41
 - Cooling mode indication, 27
 - Cooling module, 14
- D**
 - Data for energy efficiency of the system, 69
 - Delivery and handling, 7
 - Assembly, 7
 - Drawing out the cooling module, 7
 - Installation area, 7
 - Removing parts of the insulation, 9
 - Removing the covers, 8
 - Supplied components, 8
 - Transport, 7
 - Diagram, dimensioning compressor speed, 66
 - Dimensions, 62
 - Dimensions and pipe connections, 16
 - Display, 35
 - Display unit, 35
 - Back button, 35
 - Control knob, 35
 - Display, 35
 - OK button, 35
 - Status lamp, 35
 - Switch, 35
 - Disturbances in comfort, 58
 - Alarm, 58
 - Manage alarm, 58
 - Troubleshooting, 58
- Docking alternatives
 - Free cooling, 19
 - Ground water system, 19
 - Pool, 19
 - Two or more climate systems, 19
 - Ventilation recovery, 19
- Draining the climate system, 52
- Draining the hot water heater, 52
- Drawing out the cooling module, 7, 54
- E**
 - Electrical addition - maximum output, 23
 - Setting max electrical output, 23
 - Electrical cabinets, 13
 - Electrical connections, 20
 - Accessibility, electrical connection, 20
 - Cable lock, 21
 - Connecting accessories, 28
 - Connecting external operating voltage for the control system, 22
 - Connections, 22
 - Electrical addition - maximum output, 23
 - General, 20
 - Load monitor, 25
 - Miniature circuit-breaker, 20
 - myUplink, 25
 - Optional connections, 25
 - Outdoor sensor, 23
 - Power connection, 22
 - Removing the cover, base board, 21
 - Removing the cover, immersion heater circuit board, 21
 - Removing the hatch, input circuit board, 21
 - Room sensor, 23
 - Settings, 23
 - Standby mode, 24
 - Temperature limiter, 20
 - Temperature sensor, external flow line, 23
 - Emptying the brine system, 53
 - Energy labelling, 68
 - Data for energy efficiency of the package, 69
 - Information sheet, 68–69
 - Technical documentation, 70, 72
 - External connection options, 26
 - Possible selection for AUX inputs, 26
 - External connection options (AUX)
 - Control of ground water pump, 27
 - Cooling mode indication, 27
 - Extra circulation pump, 27
 - Hot water circulation, 27
 - Optional selection for AUX output (potential-free variable relay), 27
 - Extra circulation pump, 27
- F**
 - Filling and venting, 29
 - Filling and venting the brine system, 29
 - Filling the hot water heater, 29
 - Filling and venting the brine system, 29
 - Filling the hot water heater, 29
- H**
 - Helping the circulation pump to start, 53
 - Help menu, 38
 - Hot water circulation, 27

- I**
- Important information, 4
 - Recovery, 5
- Information sheet, 68
- Inspection of the installation, 6
- Installation alternative
 - Buffer vessel UKV, 18
 - Water heater with immersion heater, 18
- Installation area, 7
- M**
- Manage alarm, 58
- Marking, 5
- Menu 5 - SERVICE, 41
- Menu system, 35
 - Help menu, 38
 - Operation, 37
 - Scroll through the windows, 38
 - Selecting menu, 37
 - Selecting options, 37
 - Setting a value, 37
 - Use the virtual keyboard, 38
- Miniature circuit-breaker, 20
- myUplink, 25
- O**
- OK button, 35
- Operation, 37
- Optional connections, 25
- Outdoor sensor, 23
- P**
- Pipe and ventilation connections
 - Climate system, 18
 - Connecting the climate system, 18
- Pipe connections, 15
 - Brine side, 17
 - Cold and hot water
 - Connecting cold and hot water, 18
 - Dimensions and pipe connections, 16
 - General, 15
 - Pipe dimensions, 16
 - Symbol key, 15
 - System diagram, 16
- Pipe dimensions, 16
- Possible selection for AUX inputs, 26
- Possible selection for AUX output (potential free variable relay), 27
- Post adjustment and bleeding, 31
 - Pump adjustment, automatic operation, 31
 - Pump adjustment, manual operation, 31
 - Pump capacity diagram, brine side, manual operation, 31
- Power connection, 22
- Preparations, 29
- Pump adjustment, automatic operation, 31
 - Brine side, 31
 - Climate system, 31
- Pump adjustment, manual operation, 31
 - Climate system, 31
- Pump capacity diagram, brine side, manual operation, 31
- R**
- Remove parts of the insulation, 9
- Removing the cover, base board, 21
- Removing the cover, immersion heater circuit board, 21
- Removing the covers, 8
- Removing the hatch, input circuit board, 21
- Room sensor, 23
- S**
- Safety information
 - Inspection of the installation, 6
 - Marking, 5
 - Symbols, 4–5
- Scroll through the windows, 38
- Selecting menu, 37
- Selecting options, 37
- Service, 52
 - Service actions, 52
- Service actions, 52
 - Draining the climate system, 52
 - Draining the hot water heater, 52
 - Drawing out the cooling module, 54
 - Emptying the brine system, 53
 - Helping the circulation pump to start, 53
 - Standby mode, 52
 - Temperature sensor data, 54
 - USB service outlet, 55
- Setting a value, 37
- Settings, 23
- Standby mode, 52
 - Power in emergency mode, 24
- Start guide, 30
- Status lamp, 35
- Supplied components, 8
- Switch, 35
- Symbol key, 15
- Symbols, 4–5
- System diagram, 16
- T**
- Technical data, 62
 - Dimensions, 62
 - Energy labelling, 68
 - Data for energy efficiency of the system, 69
 - Information sheet, 68
 - Technical documentation, 70
 - Technical Data, 64
- Technical Data, 64
 - Diagram, dimensioning compressor speed, 66
 - Working range heat pump, 66
- Technical documentation, 70
- Temperature limiter, 20
 - Resetting, 20
- Temperature sensor, external flow line, 23
- Temperature sensor data, 54
- The heat pump's design
 - Component list, cooling module, 14
 - Component location, cooling module, 14
- The heat pump design, 11
 - Component list electrical cabinets, 13
 - Component location electrical cabinets, 13
 - Component locations, 11
 - List of components, 11
- Topping up the climate system, 29
- Transport, 7
- Troubleshooting, 58
- U**
- USB service outlet, 55
- Use the virtual keyboard, 38
- V**
- Venting the brine system, 30
- Venting the climate system, 29
- W**
- Working range heat pump, 66

Contact information

AUSTRIA

KNV Energietechnik GmbH
Gahberggasse 11, 4861 Schörfling
Tel: +43 (0)7662 8963-0
mail@knv.at
knv.at

FINLAND

NIBE Energy Systems Oy
Juurakkotie 3, 01510 Vantaa
Tel: +358 (0)9 274 6970
info@nibe.fi
nibe.fi

GREAT BRITAIN

NIBE Energy Systems Ltd
3C Broom Business Park,
Bridge Way, S41 9QG Chesterfield
Tel: +44 (0)330 311 2201
info@nibe.co.uk
nibe.co.uk

POLAND

NIBE-BIAWAR Sp. z o.o.
Al. Jana Pawla II 57, 15-703 Białystok
Tel: +48 (0)85 66 28 490
biawar.com.pl

CZECH REPUBLIC

Družstevní závody Dražice - strojírna
s.r.o.
Dražice 69, 29471 Benátky n. Jiz.
Tel: +420 326 373 801
nibe@nibe.cz
nibe.cz

FRANCE

NIBE Energy Systems France SAS
Zone industrielle RD 28
Rue du Pou du Ciel, 01600 Reyrieux
Tél: 04 74 00 92 92
info@nibe.fr
nibe.fr

NETHERLANDS

NIBE Energietechnik B.V.
Energieweg 31, 4906 CG Oosterhout
Tel: +31 (0)168 47 77 22
info@nibenl.nl
nibenl.nl

SWEDEN

NIBE Energy Systems
Box 14
Hannabadsvägen 5, 285 21 Markaryd
Tel: +46 (0)433-27 30 00
info@nibe.se
nibe.se

DENMARK

Vølund Varmeteknik A/S
Industrivej Nord 7B, 7400 Herning
Tel: +45 97 17 20 33
info@volundvt.dk
volundvt.dk

GERMANY

NIBE Systemtechnik GmbH
Am Reiherpfahl 3, 29223 Celle
Tel: +49 (0)5141 75 46 -0
info@nibe.de
nibe.de

NORWAY

ABK-Qviller AS
Brobekkeveien 80, 0582 Oslo
Tel: (+47) 23 17 05 20
post@abkqviller.no
nibe.no

SWITZERLAND

NIBE Wärmetechnik c/o ait Schweiz AG
Industriepark, CH-6246 Altishofen
Tel. +41 (0)58 252 21 00
info@nibe.ch
nibe.ch

For countries not mentioned in this list, contact NIBE Sweden or check nibe.eu for more information.

NIBE Energy Systems
Hannabadsvägen 5
Box 14
SE-285 21 Markaryd
info@nibe.se
nibe.eu

IHB EN 2436-1 831654

This is a publication from NIBE Energy Systems. All product illustrations, facts and data are based on the available information at the time of the publication's approval.

NIBE Energy Systems makes reservations for any factual or printing errors in this publication.

©2024 NIBE ENERGY SYSTEMS

