

Exhaust air heat pump

NIBE F730 Stainless steel

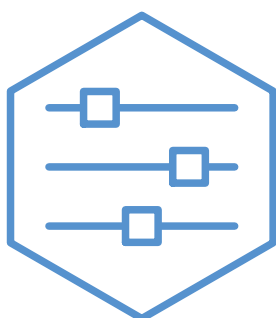

Quick guide

Navigation

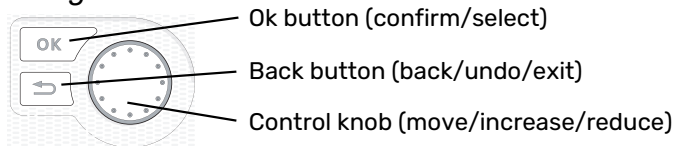

A detailed explanation of the button functions can be found on page 8.

How to scroll through menus and make different settings is described on page 10.

Set the indoor climate

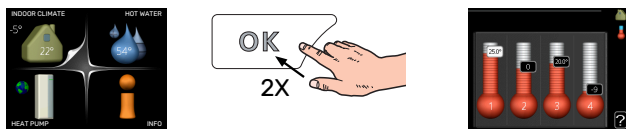

The mode for setting the indoor temperature is accessed by pressing the OK button twice, when in the start mode in the main menu. Read more about the settings on page 15.

Increase hot water volume



To temporarily increase the amount of hot water, first turn the control knob to mark menu 2 (water droplet) and then press the OK button twice. Read more about the settings on page 21.

In event of disturbances in comfort

If a disturbance in comfort of any type occurs there are some measures that can be taken before you need to contact your installer. See page 34 for instructions.

Table of Contents

1	Important information	4
	Installation data	4
	Safety information	5
	Symbols	5
	Serial number	5
	F730 – An excellent choice	6
2	The heat pump – the heart of the house ..	7
	Heat pump function	7
	Contact with F730	8
	Maintenance of F730	12
3	F730 – at your service	15
	Set the indoor climate	15
	Set the hot water capacity	21
	Get information	23
	Adjust the heat pump	25
4	Disturbances in comfort	34
	Info menu	34
	Manage alarm	34
	Troubleshooting	34
5	Technical data	37
6	Glossary	38
	Item register	40
	Contact information	43

Important information

Installation data

Product	F730
Serial number	
Installation date	
Installer	

No.	Name	Fact. sett.	Set
1.1	temperature (curve offset)	0	
1.9.1	heating curve (curve slope)	5	-1
1.9.3	min. flow line temp.	20	
5.1.5	fan sp. exhaust air (normal)	75%	
	Installed electrical output	Max	

✓	Accessories
	Extra shunt ECS 40/41
	Room unit RMU 40
	Solar panels NIBE PV

Serial number must always be given.

Certification that the installation is carried out according to instructions in the accompanying installer manual and applicable regulations.

Date

Signed

Safety information

For the latest version of the product's documentation, see nibe.eu.

This appliance can be used by children aged from 8 years and above and persons with reduced physical, sensory or mental capabilities or lack of experience and knowledge if they have been given supervision or instruction concerning use of the appliance in a safe way and understand the hazards involved. Children shall not play with the appliance. Cleaning and user maintenance shall not be made by children without supervision.

This is an original manual. It may not be translated without the approval of NIBE.

Rights to make any design or technical modifications are reserved.

©NIBE 2024.

Do not start F730 if there is a risk that the water in the system has frozen.

Water may drip from the safety valve. A factory-fitted overflow pipe runs from the safety valve to an overflow cup. An overflow pipe runs from the overflow cup to a suitable drain. The mouth of the overflow pipe must be open. The safety valve must be actuated regularly to remove dirt and to check that it is not blocked.

If the supply cable is damaged, only NIBE, its service representative or similar authorised person may replace it to prevent any danger and damage.

Symbols

Explanation of symbols that may be present in this manual.



CAUTION!

This symbol indicates danger to person or machine.



NOTE!

This symbol indicates important information about what you should observe when maintaining your installation.



TIP!

This symbol indicates tips on how to facilitate using the product.

Serial number

The serial number can be found at the bottom right of the front cover, in the info menu (menu 3.1) and on the type plate.

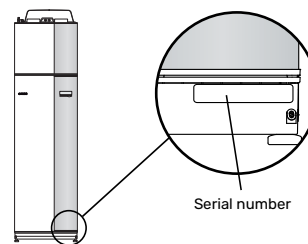

NOTE!

You need the product's (14 digit) serial number for servicing and support.

F730 – An excellent choice

F730 is a heat pump that has been developed to supply your house with ventilation, heating and hot water in a cost-effective and environmentally friendly manner.

Heat production is reliable and economical, thanks to an integrated hot water heater, immersion heater, circulation pump and control system.

The heat pump can be connected to an optional low temperature heat distribution system. e.g. radiators, convectors or underfloor heating. It is also prepared for connection to several different accessories, for example climate systems with different temperatures.

F730 is equipped with a control computer for good comfort, good economy and safe operation. Clear information about status, operation time and all temperatures in the heat pump are shown on the large and easy to read display. This means, for example, that external unit thermometers are not necessary.

EXCELLENT PROPERTIES FOR F730:

- *Inverter controlled compressor*

The heat pump has an inverter-controlled compressor that automatically adapts itself optimally and economically to your house and supplies your installation with heating and hot water.

- *Integrated water heater*

There is a water heater integrated in the heat pump, which is insulated with environmentally friendly cellular plastic for minimal heat loss.

- *Scheduling the indoor comfort and hot water*

Heating and hot water as well as ventilation, can be scheduled for each day of the week or for longer periods (vacation).

- *Display with user instructions*

The heat pump has a large display with easy-to-understand menus that facilitate setting a comfortable climate.

- *Simple troubleshooting*

In the event of a fault, the heat pump display shows what happened and the actions to be taken.

The heat pump – the heart of the house

Heat pump function

An exhaust air heat pump utilises the heat in the house's ventilation air to heat up the dwelling. The ventilation air's energy is converted to residential heating in three different circuits. From the outgoing ventilation air (1), heating energy is recovered from the dwelling and transferred to the heat pump. The heat pump increases the recovered heat's low temperature to a high temperature in the refrigerant circuit (2). The heat is distributed around the house in the heating medium circuit (3).

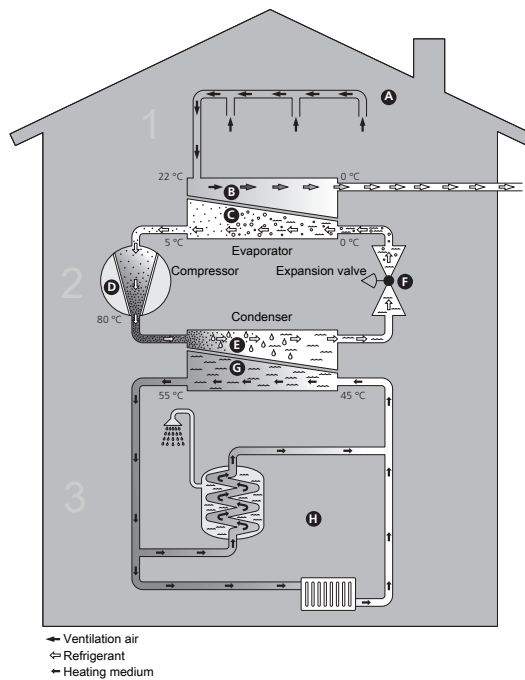

The temperatures are only examples and may vary between different installations and time of year.

Ventilation air

- A The hot air (exhaust air) is transferred from the rooms to the heat pump via the house ventilation system.
- B The fan then routes the air to the heat pump's evaporator. Here, the air releases the thermal energy and the air's temperature drops significantly. The cold air (extract air) is then blown out of the house.

Refrigerant circuit

- C A liquid, a refrigerant, circulates in a closed system in the heat pump which also passes the evaporator. The refrigerant has a very low boiling point. In the evaporator the refrigerant receives the heat energy from the ventilation air and starts to boil.
- D The gas that is produced during boiling is routed into an electrically powered compressor. When the gas is compressed, the pressure increases and the gas's temperature increases considerably, from approx. -5°C to approx. 100°C .
- E From the compressor, the gas is forced into a heat exchanger, condenser, where it releases heat energy to the heat pump's heating section, whereupon the gas is cooled and condenses to liquid form again.
- F As the pressure is still high, the refrigerant can pass an expansion valve, where the pressure drops so that the refrigerant returns to its original temperature. The refrigerant has now completed a full cycle. It is routed to the evaporator again and the process is repeated.

Heat medium circuit

- G The heat energy that the refrigerant produces in the condenser is retrieved by the climate system's water, heating medium, which is heated to 55°C (supply temperature).
- H The heating medium circulates in a closed system and transports the heated water's heat energy to the heat pump's integrated hot water heater and the radiators/heating coils of the house.
- I The heat pump's integrated water heater is in the heating section. The heating medium heats the hot water.

Contact with F730

EXTERNAL INFORMATION

When the heat pump door is closed, information can be received via an information window and a status lamp.

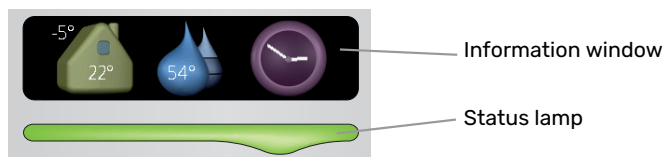

Information window

The information window shows part of the display that is on the display unit (located behind the door to the heat pump). The information window can display different type of information, e.g. temperatures, clock, etc.

You determine what is to be displayed in the information window. Your own combination of information is entered using the display unit. This information is specific to the information window and disappears when the heat pump door is opened.

Status lamp

The status lamp indicates the status of the heat pump: continuous green light during normal function, continuous yellow light during activated emergency mode or continuous red light in the event of a deployed alarm.

Alarm management is described on page 34.

DISPLAY UNIT

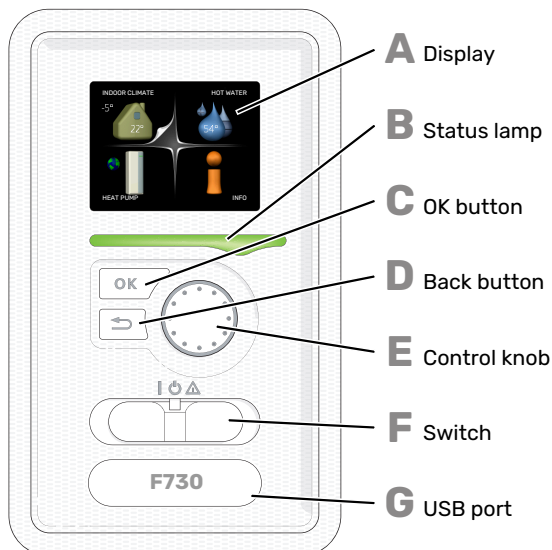

There is a display unit behind the heat pump door, which is used to communicate with F730. Here you:

- switch on, switch off or set the heat pump in emergency mode.
- sets the indoor climate and hot water as well as adjusts the heat pump to your needs.
- receive information about settings, status and events.
- see different types of alarms and receive instructions about how they are to be rectified.

A Display

Instructions, settings and operational information are shown on the display. You can easily navigate between the different menus and options to set the comfort or obtain the information you require.

B Status lamp

The status lamp indicates the status of the heat pump. It:

- lights green during normal operation.
- lights yellow in emergency mode.
- lights red in the event of a deployed alarm.

C OK button

The OK button is used to:

- confirm selections of sub menus/options/set values/page in the start guide.

D Back button

The back button is used to:

- go back to the previous menu.
- change a setting that has not been confirmed.

E Control knob

The control knob can be turned to the right or left. You can:

- scroll in menus and between options.
- increase and decrease the values.
- change page in multiple page instructions (for example help text and service info).

F Switch

The switch assumes three positions:

- On (I)
- Standby (⏻)
- Emergency mode (⚠)

Emergency mode must only be used in the event of a fault on the heat pump. In this mode, the compressor switches off and the immersion heater engages. The heat pump display is not illuminated and the status lamp illuminates yellow.

G USB port

The USB port is hidden beneath the plastic badge with the product name on it.

The USB port is used to update the software.

Visit myuplink.com and click the "Software" tab to download the latest software for your installation.

MENU SYSTEM

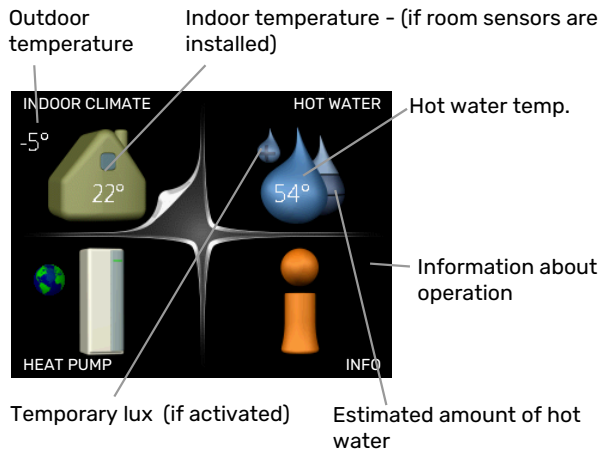

MENU 1 - INDOOR CLIMATE

Setting and scheduling the indoor climate. See page 15.

MENU 2 - HOT WATER

Setting and scheduling hot water production. See page 21.

MENU 3 - INFO

Display of temperature and other operating information and access to the alarm log. See page 23.

MENU 4 - HEAT PUMP

Setting time, date, language, display, operating mode etc. See page 25.

Symbols in the display

The following symbols may appear on the display during operation.

Symbol	Description
	This symbol appears by the information sign if there is information in menu 3.1 that you should note.
	These two symbols indicate whether the compressor or addition is blocked in F730. These can, for example, be blocked depending on which operating mode is selected in menu 4.2, if blocking is scheduled in menu 4.9.5 or if an alarm has occurred that blocks one of them. Blocking the compressor. Blocking additional heat.
	This symbol appears if periodic increase or lux mode for the hot water is activated.
	This symbol indicates whether "holiday setting" is active in 4.7.
	This symbol indicates whether F730 has contact with myUplink.
	This symbol indicates the actual speed of the fan if the speed has changed from the normal setting.
	This symbol is visible in installations with active solar accessories.

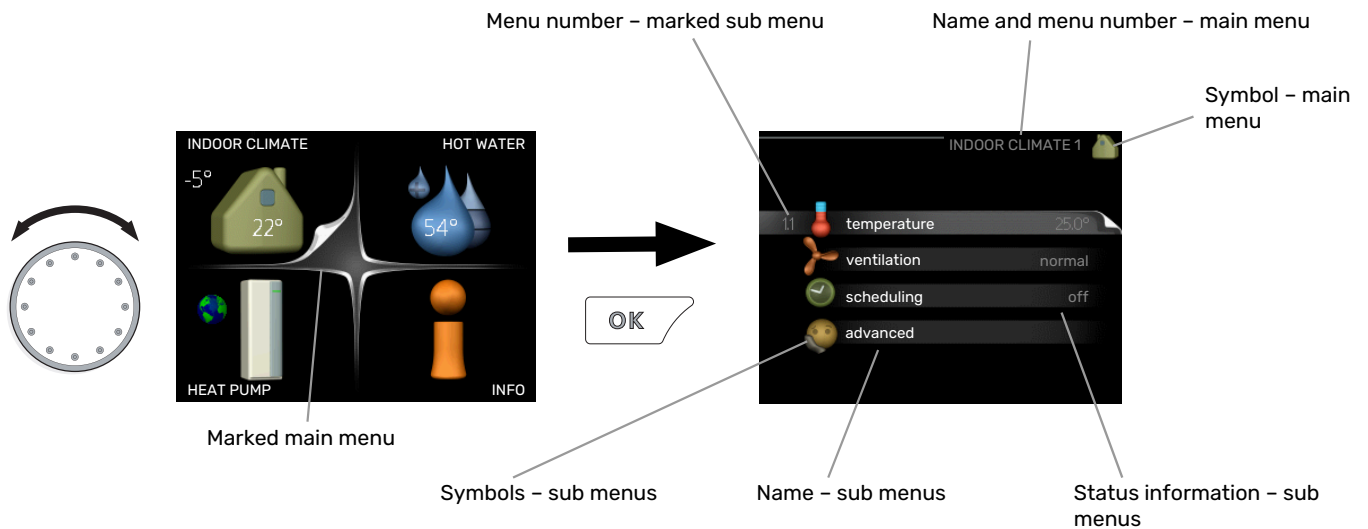

Operation

To move the cursor, turn the control knob to the left or the right. The marked position is white and/or has a turned up tab.



Selecting menu

To advance in the menu system select a main menu by marking it and then pressing the OK button. A new window then opens with sub menus.

Select one of the sub menus by marking it and then pressing the OK button.

Setting a value



Values to be changed

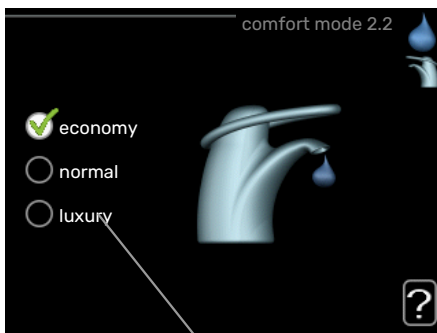

Selecting options



Alternative

In an options menu the current selected option is indicated by a green tick. 

To select another option:

1. Mark the applicable option. One of the options is pre-selected (white). 
2. Press the OK button to confirm the selected option. The selected option has a green tick. 

To set a value:

1. Mark the value you want to set using the control knob. 01
2. Press the OK button. The background of the value becomes green, which means that you have accessed the setting mode. 01
3. Turn the control knob to the right to increase the value and to the left to reduce the value. 04
4. Press the OK button to confirm the value you have set. To change and return to the original value, press the Back button. 04

Use the virtual keyboard

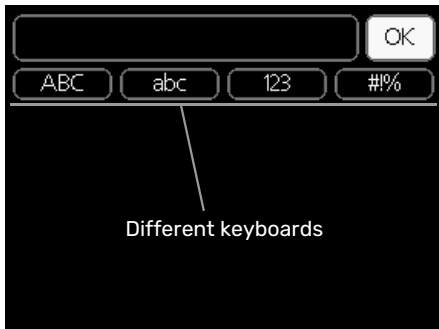

In some menus where text may require entering, a virtual keyboard is available.

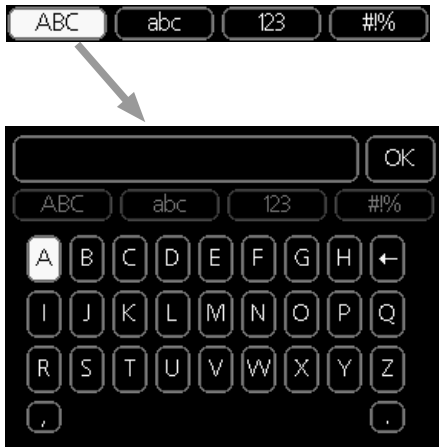

Depending on the menu, you can gain access to different character sets which you can select using the control knob. To change character table, press the Back button. If a menu only has one character set the keyboard is displayed directly. When you have finished writing, mark "OK" and press the OK button.

Scroll through the windows

A menu can consist of several windows. Turn the control knob to scroll between the windows.

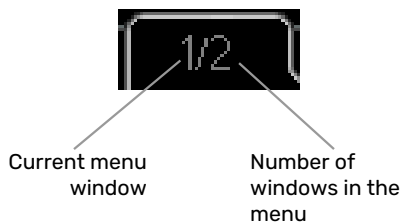

Scroll through the windows in the start guide



Arrows to scroll through window in start guide

1. Turn the control knob until one of the arrows in the top left corner (at the page number) has been marked.
2. Press the OK button to skip between the steps in the start guide.

Help menu

 In many menus there is a symbol that indicates that extra help is available.

To access the help text:

1. Use the control knob to select the help symbol.
2. Press the OK button.

The help text often consists of several windows that you can scroll between using the control knob.

Maintenance of F730

REGULAR CHECKS

Your heat pump requires minimal maintenance after commissioning. On the other hand, it is recommended that you check your installation regularly.

If something unusual occurs, messages about the malfunction appear in the display in the form of different alarm texts. See alarm management on page 34.

Service hatch

The vent valves etc. are behind the service hatch. Remove the hatch by pulling it towards you.

Cleaning the ventilation devices

The building's ventilation devices should be cleaned regularly with, for example, a small brush to maintain the correct ventilation.

The device settings must not be changed.

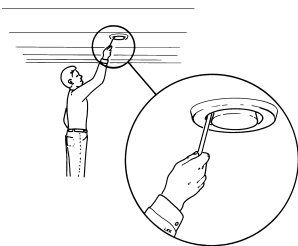

CAUTION!

If you take down more than one ventilation device for cleaning, do not mix them up.

Cleaning the air filter

The air filter in F730 has to be cleaned regularly; how often depends, for example, on the quantity of particles in the ventilation air. Test, to find out what is most appropriate for your installation.



NOTE!

The efficiency of the installation can be impaired by a dirty air filter.

You receive a reminder in the display to check the filter. The factory setting for the reminder is every three months; however, if the power supply to F730 is interrupted, the countdown starts again.

1. Turn off F730 by setting the switch to .
2. Remove the upper front cover by pulling straight out.
3. Pull out the filter cassette.
4. Remove the filter and shake/vacuum it clean.
5. Check the condition of the filter and replace if needed.
6. Carry out assembly in reverse order.

Even if the filter looks clean, dirt collects in it and this affects the efficiency of the filter. For this reason, replace the filter at least once a year. A new filter can be ordered via a dealer for NIBE or at nibe.eu.



CAUTION!

Water or other liquids must not be used for cleaning.

Filter

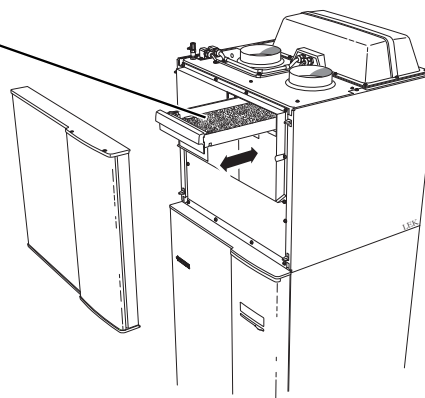

Check pressure

F730 has a pressure gauge which shows the heating system pressure. The pressure should be between 0.5 and 1.5 bar, but varies during temperature changes. If the pressure drops to 0 or rises to 2.5 frequently, contact your installer for troubleshooting.

Safety valves

F730 has two safety valves, one for the hot water and one for the climate system.

The safety valve for the climate system is factory fitted. The safety valve for the hot water is fitted by the installer.

The safety valve for the hot water sometimes releases a small quantity of water after hot water usage. This is because the cold water that enters F730 expands while heating up, causing the pressure to rise and the safety valve to open.

The climate system's safety valve must be completely sealed and normally does not release any water.

The function of the safety valves must be checked regularly. You can access the factory-fitted valve through the service hatch. Perform the checks as follows:

1. Open the valve by turning the knob anti-clockwise carefully.
2. Check that water flows through the valve.
3. Close the valve by releasing it. If it does not close automatically when released, turn it anti-clockwise slightly.
4. If the climate system needs to be refilled after checking the safety valve contact the installer.

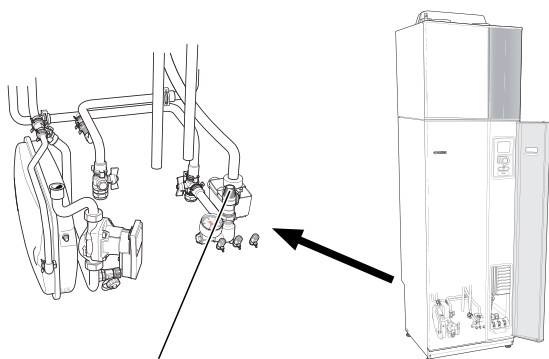

Safety valve for climate system

Contact your installer, if you are unsure about where the other safety valve is located and how to check it.

Cleaning the floor drain

Condensation forms when the heat pump is working. This condensation is routed via an overflow cup to a drain, e.g. a floor drain.

The condensation water contains a certain amount of dust and particles.

Check regularly that any floor drains are not blocked; water must be able to run through freely. Clean, if necessary.

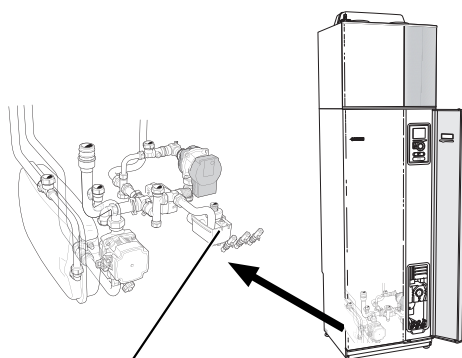

Overflow cup

Filling the climate system

If the pressure is too low: contact your installer.

Venting the climate system

In event of repeated filling of the climate system or if bubbling sounds are heard from the heat pump the system may need venting. This is carried out as follows:

1. Turn the power switch to .
2. Vent the heat pump via the vent valves and the rest of the climate system via its respective vent valves.
3. The climate system may require topping up after venting.



CAUTION!

The vent hoses from the container must be drained of water before air can be released. This means that the system is not necessarily vented despite the flow of water when the vent valves are opened.

Therefore hold the vent valves open at least 5 seconds.

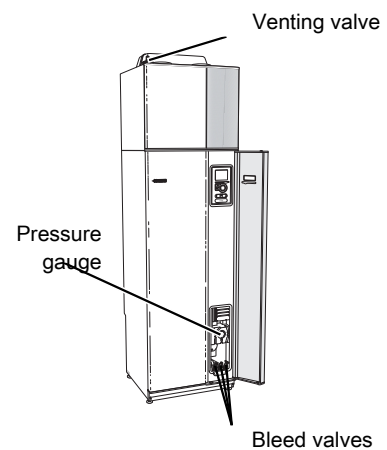

SAVING TIPS

Your heat pump installation produces heat and hot water. This occurs via the control settings you made.

Factors that affect the energy consumption are, for example, indoor temperature, hot water consumption, the insulation level of the house and whether the house has many large window surfaces. The position of the house, e.g. wind exposure is also an affecting factor.

Even the house ventilation affects the energy consumption. It is therefore important to perform a ventilation adjustment shortly after installing the heat pump. At ventilation adjustment, a ventilation technician sets the house ventilation device and the fan in F730 according to the projected values of the house.

Also remember:

- Open the thermostat valves completely (except in rooms where you want it to be cooler). This is important, as fully or partially closed thermostat valves slow the flow in the climate system, which results in F730 working at a higher temperature. This in turn can lead to increased energy consumption.
- During the adjustment period (winter time), all thermostat valves should be fully open. The heat pump's heating settings are then adjusted so that the correct indoor temperature is obtained, in most rooms, regardless of the outdoor temperature. In rooms where a lower temperature is required, the thermostat valves are lowered to the desired level. After about a month, the remaining thermostats can be lowered slightly to avoid an increase of the room temperature due to solar radiation, stove heat, etc. Further reductions may be required later on.
- You can lower the operating cost when away from home by scheduling selected parts of the system. This is done in menu 4.7 "holiday setting". See page 30 for instructions.

Power consumption

Approximate energy consumption for F730 spread across the year

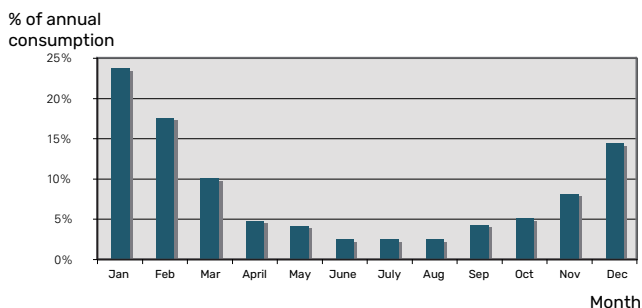

Increasing the indoor temperature by one degree increases the energy consumption by approx. 5 %.

Energy meter

Check the accommodation's energy meter regularly, preferably once a month. This will indicate any changes in power consumption.

Newly built houses usually have twin energy meters, use the difference to calculate your domestic electricity.

New builds

Newly built houses undergo a drying out process for a year. The house can then consume significantly more energy than it would thereafter. After 1-2 years the heating curve should be adjusted again, as well as the offset heating curve and the building's thermostat valves, because the heating system, as a rule, requires a lower temperature once the drying process is complete.

F730 – at your service

Set the indoor climate

OVERVIEW

Sub-menus

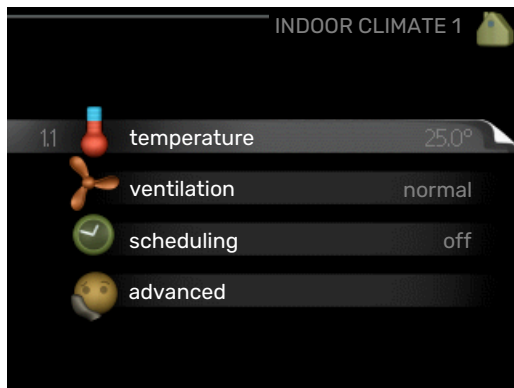

For the menu **INDOOR CLIMATE** there are several sub-menus. Status information for the relevant menu can be found on the display to the right of the menus.

temperature Setting the temperature for the climate system. The status information shows the set values for the climate system.

ventilation Setting the fan speed. The status information shows the selected setting.

scheduling Scheduling heating and ventilation. Status information "set" is displayed if you set a schedule but it is not active now, "holiday setting" is displayed if the vacation schedule is active at the same time as the schedule (the vacation function is prioritised), "active" displays if any part of the schedule is active, otherwise it displays "off".

advanced Setting of heat curve, adjusting with external contact, minimum value for supply temperature, room sensor and night cooling.

MENU 1.1 - TEMPERATURE

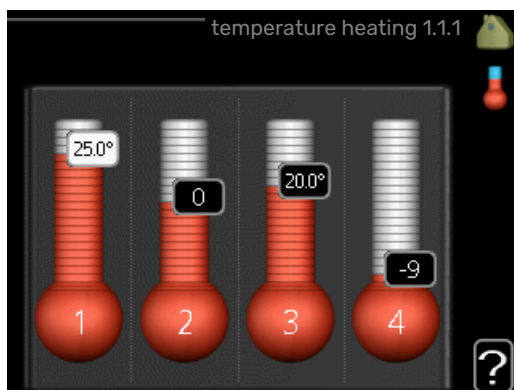

Set the temperature (with room sensor installed and activated):

heating

Setting range: 5 – 30 °C

Default value: 20

The value in the display appears as a temperature in °C if the climate system is controlled by a room sensor.

NOTE!

A slow heat-releasing heating system, such as for example, underfloor heating, may not be suitable for control using the heat pump's room sensor.

To change the room temperature, use the control knob to set the desired temperature in the display. Confirm the new setting by pressing the OK button. The new temperature is shown on the right-hand side of the symbol in the display.

Setting the temperature (without room sensors activated):

Setting range: -10 to +10

Default value: -1

The display shows the set values for heating (curve offset). To raise or lower the indoor temperature, increase or reduce the value on the display.

Use the control knob to set a new value. Confirm the new setting by pressing the OK button.

The number of steps the value has to be changed to achieve a degree change of the indoor temperature depends on the heating installation. One step is usually enough but in some cases several steps may be required.

Setting the desired value. The new value is shown on the right-hand side of the symbol in the display.

NOTE!

An increase in the room temperature can be slowed by the thermostats for the radiators or under floor heating. Therefore, open the thermostats fully, except in those rooms where a cooler temperature is required, e.g. bedrooms.

If the exhaust air temperature falls below 6 °C, the compressor is blocked and electric additional heat is permitted. No energy is recovered from the exhaust air, when the compressor is blocked.



TIP!

Wait 24 hours before making a new setting, so that the room temperature has time to stabilise.

If it is cold outdoors and the room temperature is too low, increase the curve slope in menu 1.9.1.1 by one increment.

If it is cold outdoors and the room temperature is too high, reduce the curve slope in menu 1.9.1.1 by one increment.

If it is warm outdoors and the room temperature is too low, increase the value in menu 1.1.1 by one increment.

If it is warm outdoors and the room temperature is too high, reduce the value in menu 1.1.1 by one increment.

MENU 1.2 - VENTILATION

Setting range: normal and speed 1-4

Default value: normal

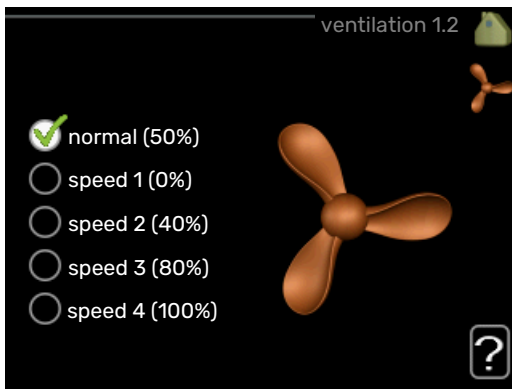

The ventilation in the accommodation can be temporarily increased or reduced here.

When you have selected a new speed a clock starts a count down. When the time has counted down the ventilation speed returns to the normal setting.

If necessary, the different return times can be changed in menu 1.9.6.

The fan speed is shown in brackets (in percent) after each speed alternative.



TIP!

If longer time changes are required use the holiday function or scheduling.



NOTE!

The heat pump requires a minimum ventilation flow in order to work properly. An insufficient ventilation flow can result in an alarm and blocking of compressor operation.

MENU 1.3 - SCHEDULING

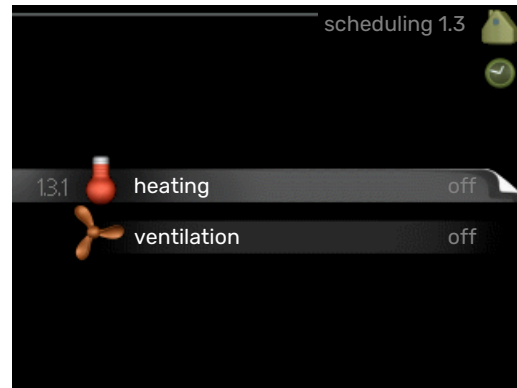

In the menu **scheduling** indoor climate (heating/ventilation) is scheduled for each weekday.

You can also schedule a longer time during a selected period (holiday) in menu 4.7.

MENU 1.3.1 - HEATING

Increases or decreases in the accommodation temperature can be scheduled here for up to three time periods per day. If a room sensor is installed and activated the desired room temperature (°C) is set during the time period. Without an activated room sensor the desired change is set (of setting in menu 1.1). One step is usually enough to change the room temperature by one degree, but in some cases several steps may be required.

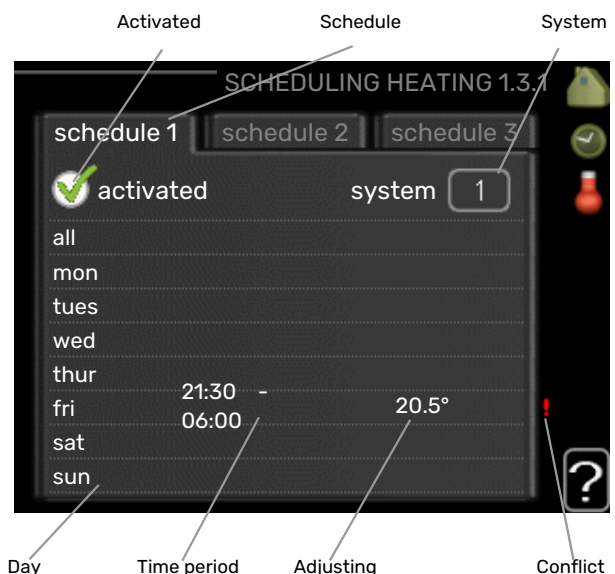

Schedule: The schedule to be changed is selected here.

Activated: Scheduling for the selected period is activated here. Set times are not affected at deactivation.

System: The climate system that the relevant schedule relates to is selected here. This alternative is only displayed if there is more than one climate system.

Day: Select which day or days of the week the scheduling is to apply to here. To remove the scheduling for a particular day, the time for that day must be reset by setting the start time to the same as the stop time. If the row "all" is used, all days in the period are set according to that row.

Time period: The start and stop time for the selected day for scheduling are selected here.

Adjustment: How much the heating curve is to be offset in relation to menu 1.1 during scheduling is set here. If a room sensor is installed, the desired room temperature is set in °C.

Conflict: If two settings conflict with each other, a red exclamation mark is displayed.

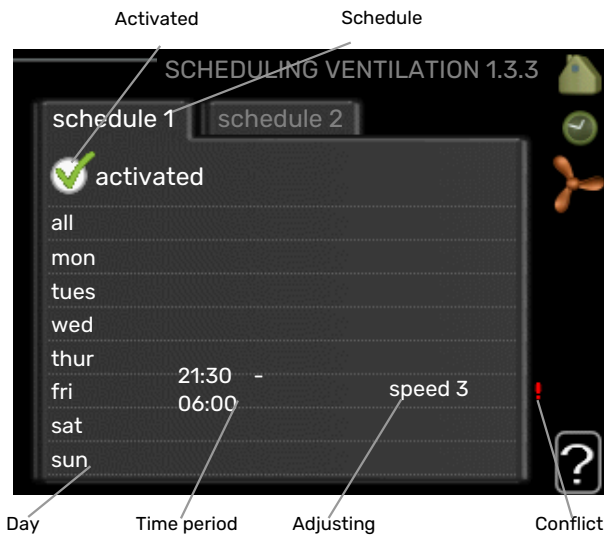

Schedule: The schedule to be changed is selected here.

Activated: Scheduling for the selected period is activated here. Set times are not affected at deactivation.

Day: Select which day or days of the week the scheduling is to apply to here. To remove the scheduling for a particular day, the time for that day must be reset by setting the start time to the same as the stop time. If the row "all" is used, all days in the period are set according to that row.

Time period: The start and stop time for the selected day for scheduling are selected here.

Adjustment: The desired fan speed is set here.

Conflict: If two settings conflict with each other, a red exclamation mark is displayed.



TIP!

If you wish to set similar scheduling for every day of the week start by filling in "all" and then changing the desired days.



TIP!

Set the stop time earlier than the start time so that the period extends beyond midnight. Scheduling then stops at the set stop time the day after.

Scheduling always starts on the date that the start time is set for.



NOTE!

Changes of temperature in accommodation take time. For example, short time periods in combination with underfloor heating will not give a noticeable difference in room temperature.

If the exhaust air temperature falls below 6 °C, the compressor is blocked and electric additional heat is permitted. No energy is recovered from the exhaust air, when the compressor is blocked.



TIP!

If you wish to set similar scheduling for every day of the week start by filling in "all" and then changing the desired days.



TIP!

Set the stop time earlier than the start time so that the period extends beyond midnight. Scheduling then stops at the set stop time the day after.

Scheduling always starts on the date that the start time is set for.



NOTE!

A significant change over a longer period of time may cause poor indoor environment and worse operating economy.

MENU 1.3.3 - VENTILATION

Increases or decreases in the ventilation to the accommodation can be scheduled here for up to two time periods per day.

MENU 1.9 - ADVANCED

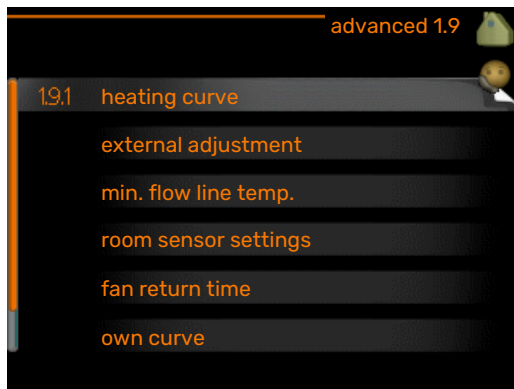

Menu **advanced** has orange text and is intended for the advanced user. This menu has several sub-menus.

heating curve Setting the heating curve slope.

external adjustment Setting the heat curve offset when the external contact is connected.

min. flow line temp. Setting minimum permitted flow line temperature.

room sensor settings Settings regarding the room sensor.

fan return time Fan return time settings in the event of temporary ventilation speed change.

own curve Setting own heat curve.

point offset Setting the offset of the heating curve at a specific outdoor temperature.

night cooling Setting night cooling.

MENU 1.9.1 - HEATING CURVE

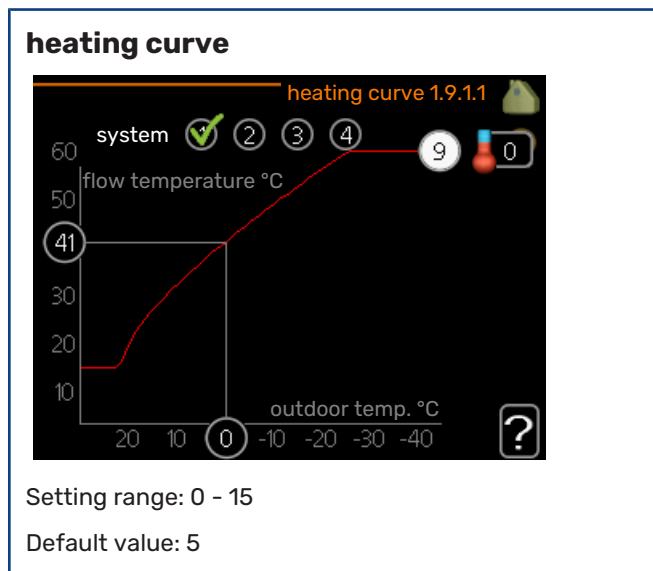

The prescribed heating curve for your house can be viewed in the menu **heating curve**. The task of the heating curve is to give an even indoor temperature, regardless of the outdoor temperature, and thereby energy efficient operation. It is from this heating curve that the heat pump's control computer determines the temperature of the water to the heating system, supply temperature, and therefore the in-

door temperature. Select the heating curve and read off how the supply temperature changes at different outdoor temperatures here.

NOTE!

With underfloor heating systems, **max flow line temperature** should normally be set to between 35 and 45 °C.

Check the max temperature for your floor with your installer/floor supplier.

TIP!

Wait 24 hours before making a new setting, so that the room temperature has time to stabilise.

If it is cold outdoors and the room temperature is too low, increase the curve slope by one increment.

If it is cold outdoors and the room temperature is too high, lower the curve slope by one increment.

If it is warm outdoors and the room temperature is too low, increase the curve offset by one increment.

If it is warm outdoors and the room temperature is too high, lower the curve offset by one increment.

MENU 1.9.2 - EXTERNAL ADJUSTMENT

Set the temperature (with room sensor installed and activated):

Setting range: 5 - 30 °C

Default value: 20

Setting the temperature (without room sensors activated):

Setting range: -10 to +10.

Default value: 0

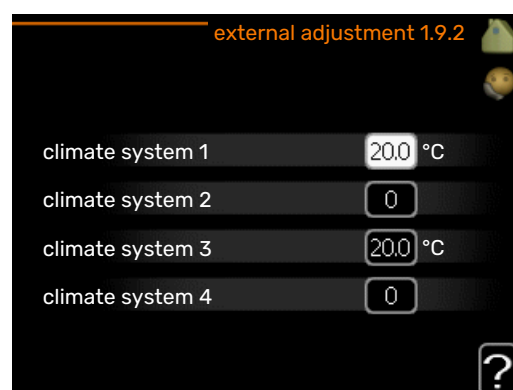

Connecting an external contact, for example, a room thermostat or a timer allows you to temporarily or periodically raise or lower the room temperature while heating. When the contact is on, the heating curve offset is changed by

the number of steps selected in the menu. If a room sensor is installed and activated the desired room temperature (°C) is set.

If there is more than one climate system the setting can be made separately for each system.

MENU 1.9.3 - MIN. FLOW LINE TEMP.

heating

Setting range: 20-70 °C

Default value: 20 °C

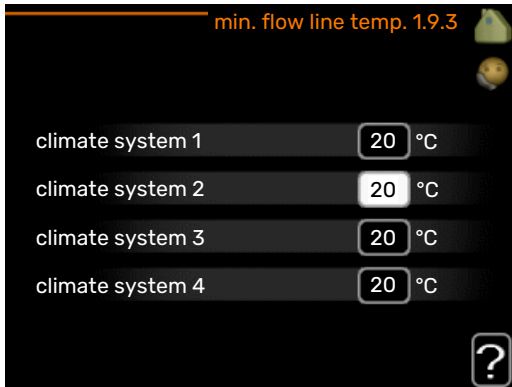

Set the minimum temperature on the supply temperature to the climate system. This means that F730 never calculates a temperature lower than that set here.

If there is more than one climate system the setting can be made separately for each system.



TIP!

The value can be increased if you have, for example, a cellar that you always want to heat, even in summer.

You may also need to increase the value in "stop heating" menu 4.9.2 "auto mode setting".

MENU 1.9.4 - ROOM SENSOR SETTINGS

factor system

Setting range: 0.0 - 6.0

Default value: 2.0

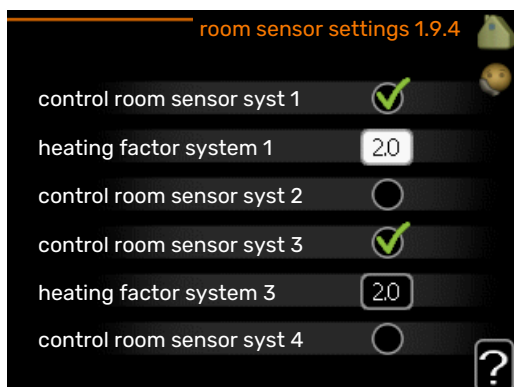

Room sensors to control the room temperature can be activated here.



NOTE!

A slow heating system such as underfloor heating may not be suitable for control using the installation's room sensors.

Here you can set a factor (a numerical value) that determines how much an over or sub normal temperature (the difference between the desired and actual room temperature) in the room is to affect the supply temperature to the climate system. A higher value gives a greater and faster change of the heating curve's set offset.



CAUTION!

Too high a set value for "factor system" can (depending on your climate system) produce an unstable room temperature.

If several climate systems are installed the above settings can be made for the relevant systems.

MENU 1.9.6 - FAN RETURN TIME

speed 1-4

Setting range: 1 - 99 h

Default value: 4 h

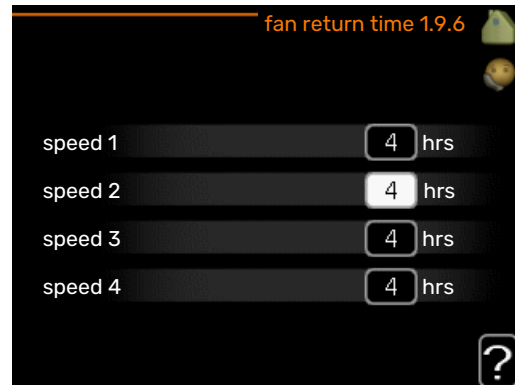

Here you select the return time for temporary speed change (speed 1-4) on the ventilation in menu 1.2.

Return time is the time it takes before ventilation speed returns to normal.

MENU 1.9.7 - OWN CURVE

supply temperature

Setting range: 0 - 80 °C

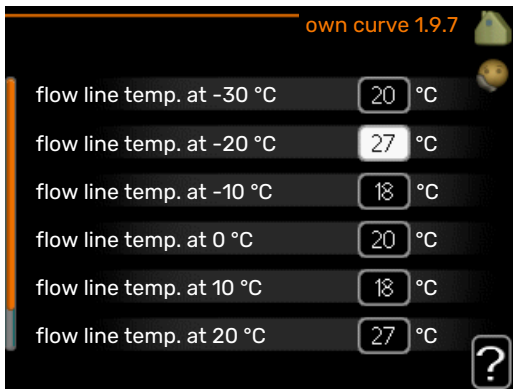

You can create your own heating curve here, if there are special requirements, by setting the desired supply temperatures for different outdoor temperatures.



NOTE!

Curve 0 in menu 1.9.1 must be selected for own curve to apply.

MENU 1.9.8 - POINT OFFSET

outdoor temp. point

Setting range: -40 – 30 °C

Default value: 0 °C

change in curve

Setting range: -10 – 10 °C

Default value: 0 °C

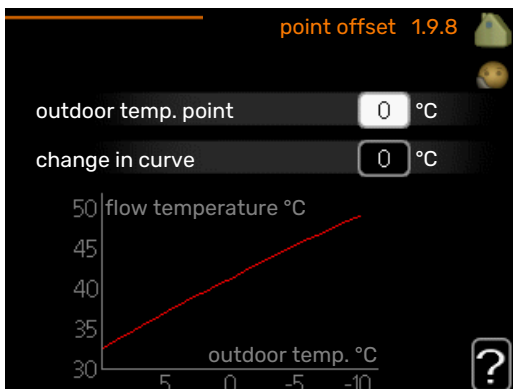

Select a change in the heating curve at a certain outdoor temperature here. One step is usually enough to change the room temperature by one degree, but in some cases several steps may be required.

The heat curve is affected at $\pm 5^\circ\text{C}$ from set outdoor temp. point.

It is important that the correct heating curve is selected so that the room temperature is experienced as even.



TIP!

If it is cold in the house, at, for example -2°C , "outdoor temp. point" is set to "-2" and "change in curve" is increased until the desired room temperature is maintained.



NOTE!

Wait 24 hours before making a new setting, so that the room temperature has time to stabilise.

MENU 1.9.9 - NIGHT COOLING

start temp. exhaust air

Setting range: 20 – 30 °C

Default value: 25 °C

min diff. outdoor-exhaust

Setting range: 3 – 10 °C

Default value: 6 °C

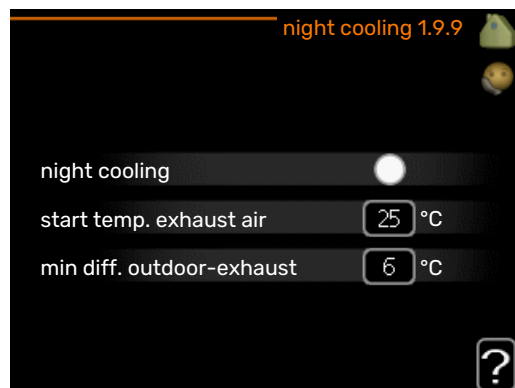

Activate night cooling here.

When the temperature in the house is high and the outdoor temperature is lower, a cooling effect can be obtained by forcing the ventilation.

If the temperature difference between the exhaust air and the outdoor air temperature is greater than the set value ("min diff. outdoor-exhaust") and the exhaust air temperature is higher than the set value ("start temp. exhaust air"), run the ventilation at speed 4 until one of the conditions is no longer met.



NOTE!

Night cooling can only be activated when house heating has been deactivated. This is done in menu 4.2.

Set the hot water capacity

OVERVIEW

Sub-menus



For the menu **HOT WATER** there are several sub-menus. Status information for the relevant menu can be found on the display to the right of the menus.

temporary lux Activation of temporary increase in the hot water temperature. Status information displays "off" or what length of time of the temporary temperature increase remains.

comfort mode Setting hot water comfort. The status information displays what mode is selected, "economy", "normal" or "luxury".

scheduling Scheduling hot water comfort. The status information "set" appears if you have set scheduling but it is not currently active, "holiday setting" appears if holiday setting is active at the same time as scheduling (when the holiday function is prioritised), "active" appears if any part of scheduling is active, otherwise "off" appears.

advanced Setting periodic increase in the hot water temperature.

MENU 2.1 - TEMPORARY LUX

Setting range: 3, 6 and 12 hours and mode "off" and "one time increase"

Default value: "off"

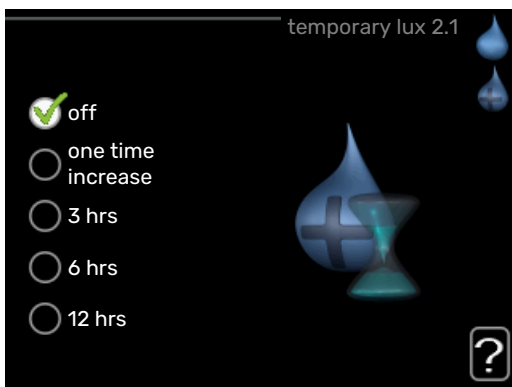

When hot water requirement has temporarily increased this menu can be used to select an increase in the hot water temperature to lux mode for a selectable time.

NOTE!

If comfort mode "luxury" is selected in menu 2.2 no further increase can be carried out.

The function is activated immediately when a time period is selected and confirmed using the OK button. The remaining time for the selected setting is shown to the right.

When the time has run out F730 returns to the mode set in menu 2.2.

Select "off" to switch off **temporary lux**.

MENU 2.2 - COMFORT MODE

Setting range: economy, normal, luxury

Default value: normal



The difference between the selectable modes is the temperature of the hot tap water. Higher temperature means that the hot water lasts longer.

economy: This mode produces less hot water than the others, but is more economical. This mode can be used in smaller households with a small hot water requirement.

normal: Normal mode gives a larger amount of hot water and is suitable for most households.

luxury: Lux mode gives the greatest possible amount of hot water. In this mode, the immersion heater is used to heat hot water as well as the compressor, which increases operating costs.

MENU 2.3 - SCHEDULING

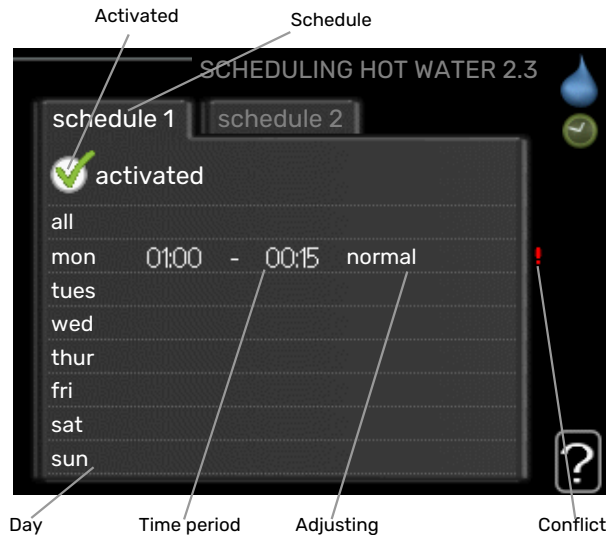

What hot water comfort the heat pump is to work with can be scheduled here for up to two different time periods per day.

Scheduling is activated/deactivated by ticking/unticking "activated". Set times are not affected at deactivation.

Schedule: The schedule to be changed is selected here.

Activated: Scheduling for the selected period is activated here. Set times are not affected at deactivation.

Day: Select which day or days of the week the scheduling is to apply to here. To remove the scheduling for a particular day, the time for that day must be reset by setting the start time to the same as the stop time. If the row "all" is used, all days in the period are set according to that row.

Time period: The start and stop time for the selected day for scheduling are selected here.

Adjustment: Set the hot water comfort that is to apply during scheduling here.

Conflict: If two settings conflict with each other, a red exclamation mark is displayed.



TIP!

If you wish to set similar scheduling for every day of the week start by filling in "all" and then changing the desired days.



TIP!

Set the stop time earlier than the start time so that the period extends beyond midnight. Scheduling then stops at the set stop time the day after.

Scheduling always starts on the date that the start time is set for.

MENU 2.9 - ADVANCED

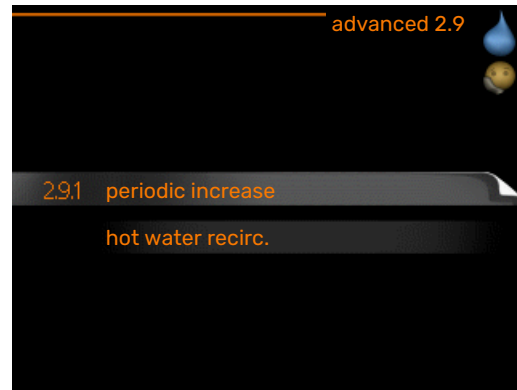

Menu **advanced** has orange text and is intended for the advanced user. This menu has several sub-menus.

MENU 2.9.1 - PERIODIC INCREASE

period

Setting range: 1 - 90 days

Factory setting: 7 days

start time

Setting range: 00:00 - 23:00

Default value: 00:00

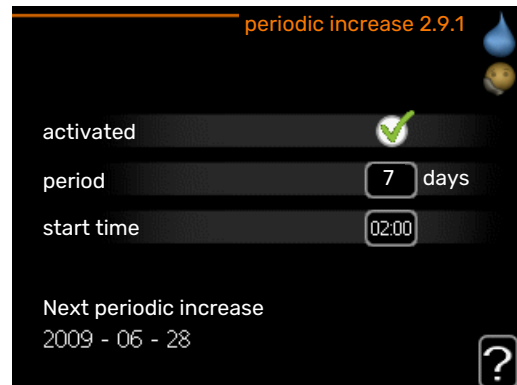

To prevent bacterial growth in the water heater, the compressor and the immersion heater can increase the hot water temperature for a short time at regular intervals.

Here, you can select the length of time between increases in the hot water temperature. The time can be set between 1 and 90 days. Factory setting is 7 days. Tick/untick "activated" to start/switch off the function.

MENU 2.9.2 - HOT WATER RECIRC.

operating time

Setting range: 1 - 60 min

Default value: 60 min

downtime

Setting range: 0 - 60 min

Default value: 0 min

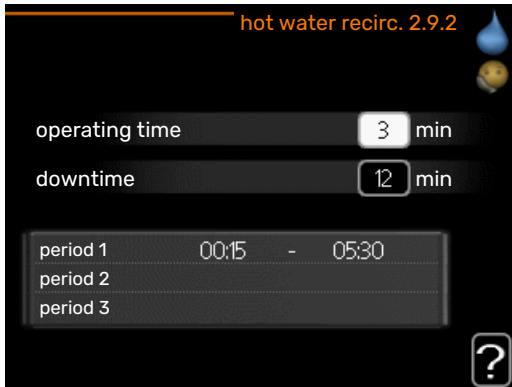

Set the hot water circulation for up to three periods per day here. During the set periods the hot water circulation pump will run according to the settings above.

"operating time" decide how long the hot water circulation pump must run per operating instance.

"downtime" decide how long the hot water circulation pump must be stationary between operating instances.

Get information

OVERVIEW

Sub-menus

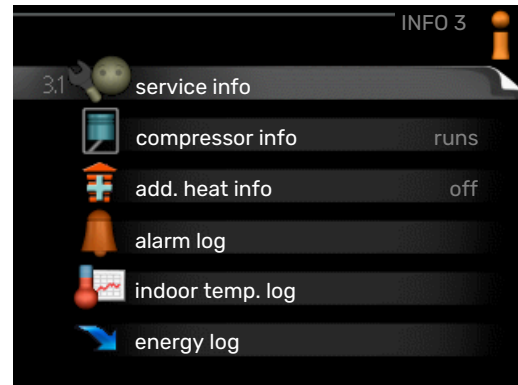

For the menu **INFO** there are several sub-menus. No settings can be made in these menus, they just display information. Status information for the relevant menu can be found on the display to the right of the menus.

service info shows temperature levels and settings in the installation.

compressor info shows operating times, number of starts etc for the compressor in the heat pump.

add. heat info displays information about the additional heat's operating times etc.

alarm log displays the latest alarm and information about the heat pump when the alarm occurred.

indoor temp. log the average temperature indoors week by week during the past year.





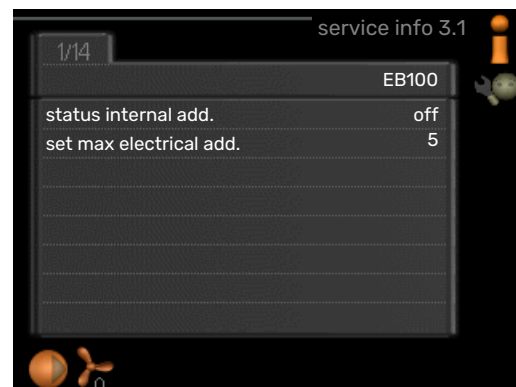

energy log the energy consumption month by month over the past year as well as the energy consumption year by year.

MENU 3.1 - SERVICE INFO



Information about the actual operating status of the installation (e.g. current temperatures etc.) can be obtained here. No changes can be made.

The information is on several pages. Turn the control knob to scroll between the pages.

Symbols in this menu:			
	Compressor		Heating
	Addition		Hot water
	Circulation pump, climate system		Ventilation
	Solar accessory		

MENU 3.2 - COMPRESSOR INFO

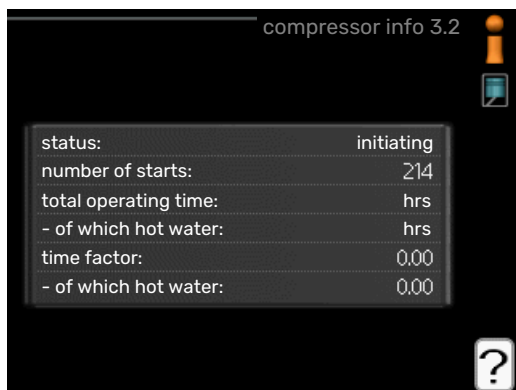

Information about the compressor's operating status and statistics can be obtained here. No changes can be made.

The information is on several pages. Turn the control knob to scroll between the pages.

MENU 3.3 - ADD. HEAT INFO

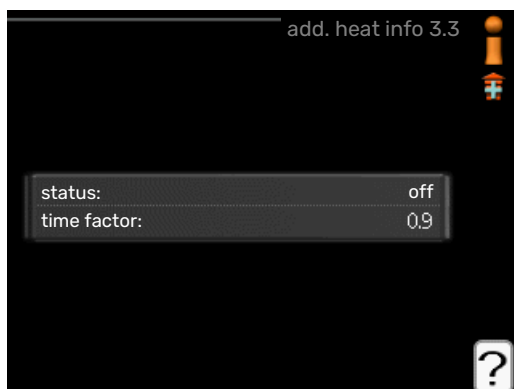

Information about the additional heat's settings, operating status and statistics can be obtained here. No changes can be made.

The information is on several pages. Turn the control knob to scroll between the pages.

MENU 3.4 - ALARM LOG

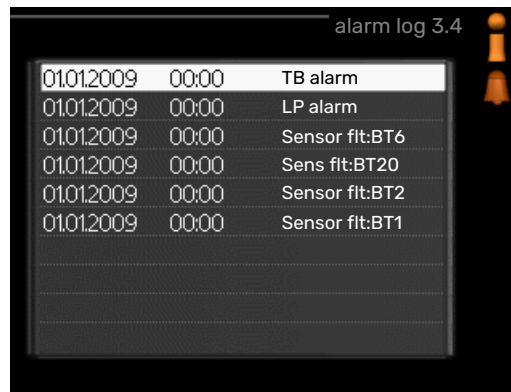

To facilitate fault-finding the heat pump operating status at alarm alerts is stored here. You can see information for the 10 most recent alarms.

To view the run status in the event of an alarm, mark the alarm and press the OK button.

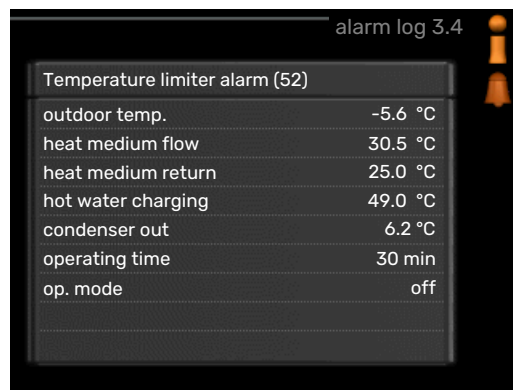

Information about an alarm.

MENU 3.5 - INDOOR TEMP. LOG

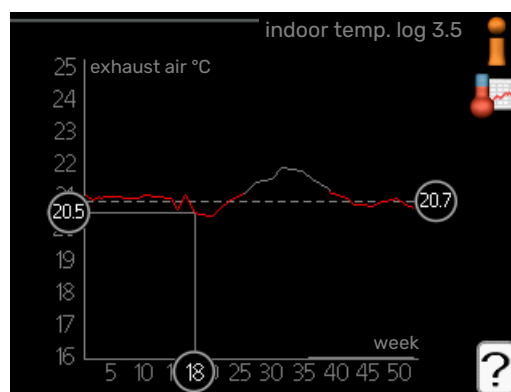

Here you can see the average temperature indoors week by week during the past year. The dotted line indicates the annual average temperature.

To read off an average temperature

1. Turn the control knob so that the ring on the shaft with the week number is marked.
2. Press the OK button.
3. Follow the grey line up to the graph and out to the left to read off the average indoor temperature at the selected week.

4. You can now select to take read outs for different weeks by turning the control knob to the right or left and read off the average temperature.
5. Press the OK or Back button to exit read off mode.

MENU 3.6 - ENERGY LOG

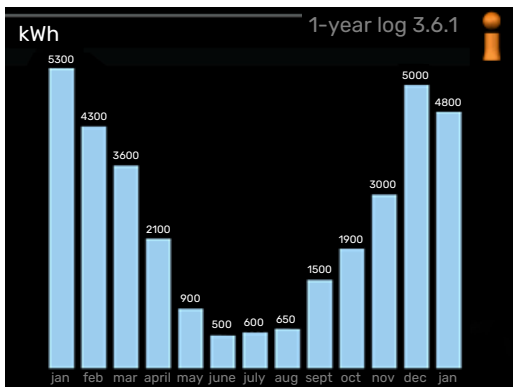

Here, you can see the energy consumption month by month over the past year as well as energy consumption year by year.

Adjust the heat pump

OVERVIEW

Sub-menus

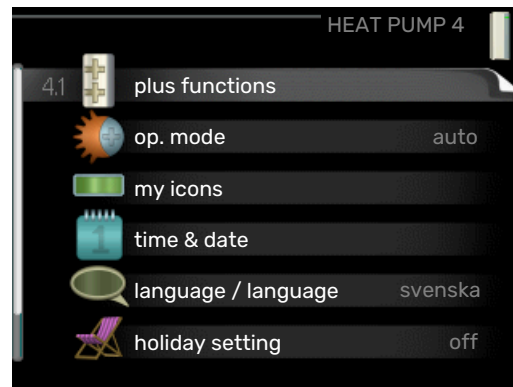

For the menu **HEAT PUMP** there are several sub-menus. Status information for the relevant menu can be found on the display to the right of the menus.

plus functions Settings applying to any installed extra functions in the heating system.

op. mode Activation of manual or automatic operating mode. The status information shows the selected operating mode.

my icons Settings regarding which icons in the heat pump's user interface that are to appear in the slot when the door is closed.

time & date Setting current time and date.

language Select the language for the display here. The status information shows the selected language.

holiday setting Vacation scheduling heating, hot water and ventilation. Status information "set" is displayed if you set a vacation schedule but it is not active at the moment, "active" is displayed if any part of the vacation schedule is active, otherwise it displays " off".

advanced Setting heat pump work mode.

MENU 4.1 - PLUS FUNCTIONS

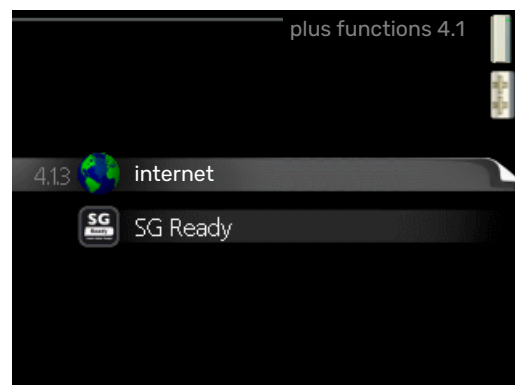

Settings for any additional functions installed in F730 can be made in the sub menus.

MENU 4.1.3 - INTERNET

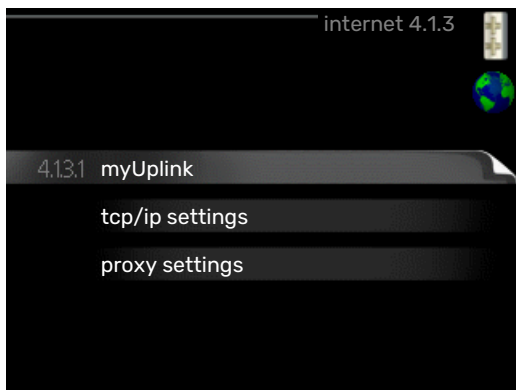

Here, you make settings for connecting F730 to the internet, via myUplink.

 **CAUTION!**
For these functions to work the network cable must be connected.

MENU 4.1.3.1 - MYUPLINK



Here you can manage the installation's connection to myUplink (myuplink.com) and see the number of users connected to the installation via the internet.

A connected user has a user account in myUplink, which has been given permission to control and/or monitor your installation.

Request new connection string

To connect a user account on myUplink to your installation, you must request a unique connection code.

1. Mark "request new connection string" and press the OK button.
2. The installation now communicates with myUplink to create a connection code.
3. When a connection string has been received, it is shown in this menu at "connection string" and is valid for 60 minutes.

Disconnect all users

1. Mark "switch off all users" and press the OK button.

2. The installation now communicates with myUplink to release your installation from all users connected via the internet.

 **CAUTION!**
After disconnecting all users none of them can monitor or control your installation via myUplink without requesting a new connection string.

MENU 4.1.3.8 - TCP/IP SETTINGS

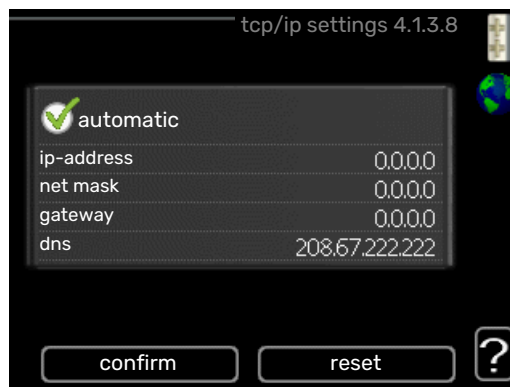

Here, you can set TCP/IP settings for your installation.

Automatic setting (DHCP)

1. Tick "automatic". The installation now receives the TCP/IP settings using DHCP.
2. Mark "confirm" and press the OK button.

Manual setting

1. Untick "automatic", you now have access to several setting options.
2. Mark "ip-address" and press the OK button.
3. Enter the correct details via the virtual keypad.
4. Select "OK" and press the OK button.
5. Repeat 1 - 3 for "net mask", "gateway" and "dns".
6. Mark "confirm" and press the OK button.

 **NOTE!**
The installation cannot connect to the internet without the correct TCP/IP settings. If unsure about applicable settings use the automatic mode or contact your network administrator (or similar) for further information.

 **TIP!**
All settings made since opening the menu can be reset by marking "reset" and pressing the OK button.

MENU 4.1.3.9 - PROXY SETTINGS

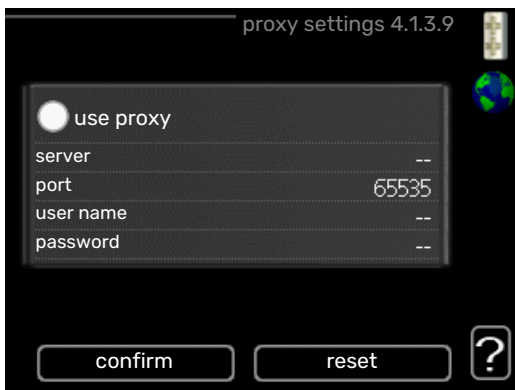

You can set proxy settings for your installation here.

Proxy settings are used to give connection information to a intermediate server (proxy server) between the installation and Internet. These settings are primarily used when the installation connects to the Internet via a company network. The installation supports proxy authentication of the HTTP Basic and HTTP Digest type.

If unsure about applicable settings, contact your network administrator (or equivalent) for further information.

Setting

1. Tick "use proxy" if you do not want to use a proxy.
2. Mark "server" and press the OK button.
3. Enter the correct details via the virtual keypad.
4. Select "OK" and press the OK button.
5. Repeat 1 - 3 for "port", "user name" and "password".
6. Mark "confirm" and press the OK button.



TIP!

All settings made since opening the menu can be reset by marking "reset" and pressing the OK button.

MENU 4.1.5 - SG READY

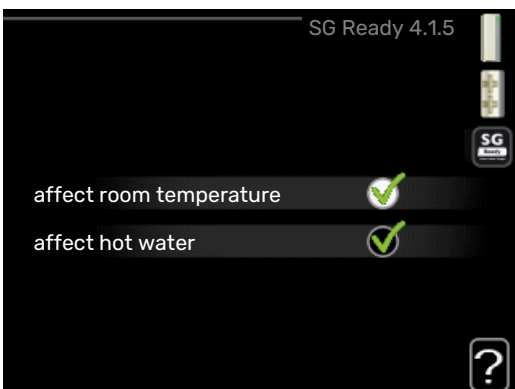

This function can only be used in mains networks that support the "SG Ready"-standard .

Make settings for the function "SG Ready" here.

affect room temperature

Here you set whether room temperature should be affected when activating "SG Ready".

With low price mode on "SG Ready" the parallel offset for the indoor temperature is increased by "+1". If a room sensor is installed and activated, the desired room temperature is instead increased by 1 °C.

With over capacity mode on "SG Ready" the parallel offset for the indoor temperature is increased by "+2". If a room sensor is installed and activated, the desired room temperature is instead increased by 2 °C.

affect hot water

Here you set whether the temperature of the hot water should be affected when activating "SG Ready".

With low price mode on "SG Ready", the stop temperature for the hot water is set as high as possible with compressor operation only (immersion heater not permitted).

With over capacity mode of "SG Ready" the hot water is set to "luxury" (immersion heater permitted).



CAUTION!

The function must be connected and activated in your F730.

MENU 4.1.6 - SMART PRICE ADAPTION™

affect room temperature

Setting range: 1 - 10

Factory setting: 5

affect hot water

Setting range: 1 - 4

Factory setting: 2

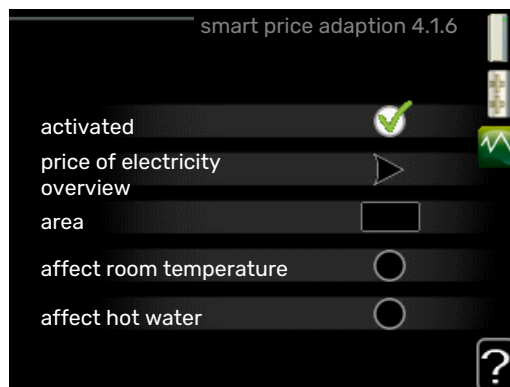

area

In this menu you state where the heat pump is located and how great a role the electricity price should play. The greater the value, the greater the effect the electricity price has and the possible savings are larger, but at the same time there is an increased risk of affecting comfort.

price of electricity overview

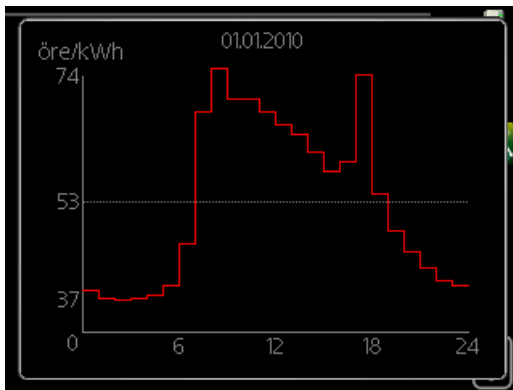

Here you can obtain information on how the electricity price varies over up to three days.

Smart price adaption™ moves the heat pump's consumption over 24 hours to periods with the cheapest electricity tariff, which gives savings for hourly rate based electricity contracts. The function is based on hourly rates for the next 24 hours being retrieved via myUplink and therefore an internet connection and an account for myUplink are required.

Deselect "activated" to switch off Smart price adaption™.

MENU 4.1.7 - SMART HOME (ACCESSORY IS REQUIRED)

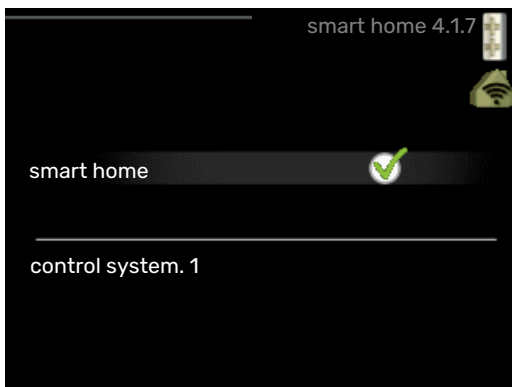

When you have a smart home system that can speak to myUplink, by activating the smart home function in this menu you can control the F730 via an app.

By allowing connected units to communicate with myUplink, your heating system becomes a natural part of your homesmart home and gives you the opportunity to optimise the operation.



NOTE!

The smart home function requires myUplink in order to work.

MENU 4.1.10 - SOLAR ELECTRICITY (ACCESSORY IS REQUIRED)

affect room temperature

Setting range: on/off

Default values: off

affect hot water

Setting range: on/off

Default values: off

prioritise domestic electricity

Setting range: on/off

Default values: off

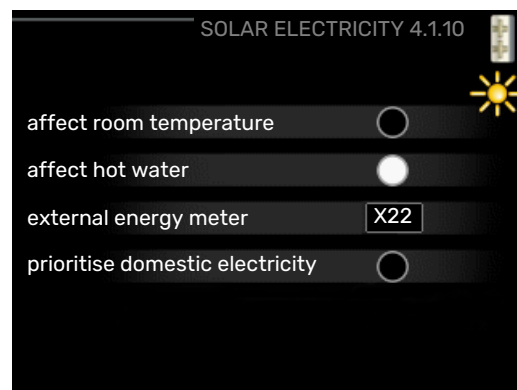

This is where you set that part of your installation (room temperature, hot water temperature) that will benefit from the surplus solar electricity.

When the solar panels produce more electricity than F730 requires, the temperature in the property is adjusted and/or the temperature of the hot water is increased.

EME

In this menu you can also make settings that are specific for your EME.

For EME 20, you can select whether you want domestic electricity to be prioritised ahead of room temperature and hot water, provided that an external energy meter is connected to F730.

MENU 4.2 - OP. MODE

op. mode

Setting range: auto, manual, add. heat only

Default value: auto

functions

Setting range: compressor, addition, heating

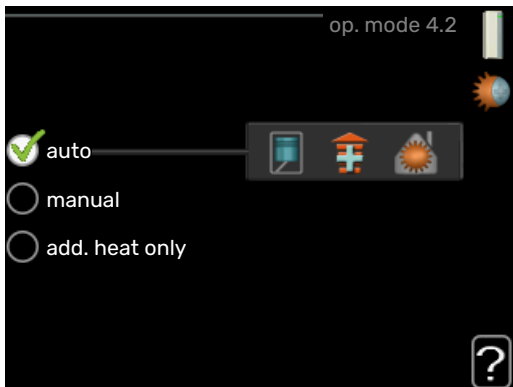

The heat pump operating mode is usually set to "auto". It is also possible to set the heat pump to "add. heat only", but only when an addition is used, or "manual" and select yourself what functions are to be permitted.

Change the operating mode by marking the desired mode and pressing the OK button. When an operating mode is selected, it shows what is permitted in the heat pump (crossed out = not permitted) and selectable alternatives to the right. To select selectable functions that are permitted or not, mark the function using the control knob and press the OK button.

Operating mode auto

In this operating mode the heat pump automatically selects what functions are permitted.

Operating mode manual

In this operating mode you can select what functions are permitted. You cannot deselect "compressor" in manual mode.

Operating mode add. heat only

In this operating mode the compressor is not active, only additional heat is used.

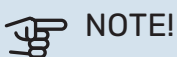

NOTE!

If you choose mode "add. heat only" the compressor is deselected and there is a higher operating cost.

Functions

"*compressor*" is the unit that produces heating and hot water for the home. If "compressor" is deselected in auto mode, this is displayed with a symbol in the main menu. You cannot deselect "compressor" in manual mode.

"*addition*" is the unit that helps the compressor to heat the home and/or the hot water when it cannot manage the entire requirement alone.

"*heating*" means you obtain heating in the home. You can deselect the function when you do not wish to have the heating on.



NOTE!

If you deselect "addition" it may mean that insufficient hot water and/or heating in the accommodation is achieved.

MENU 4.3 - MY ICONS

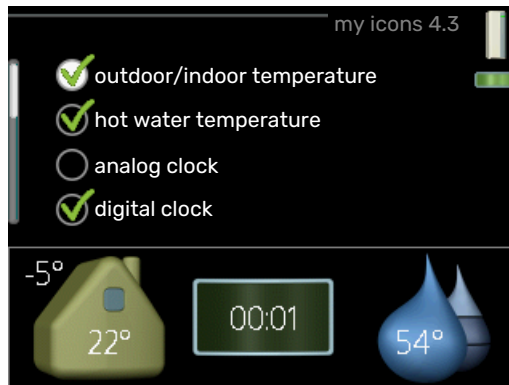

You can select what icons should be visible when the door to F730 is closed. You can select up to 3 icons. If you select more, the ones you selected first will disappear. The icons are displayed in the order you selected them.

MENU 4.4 - TIME & DATE



Set time and date, display mode and time zone here.



TIP!

Time and date are set automatically if the heat pump is connected to myUplink. To obtain the correct time, the time zone must be set.

MENU 4.6 - LANGUAGE



Choose the language that you want the information to be displayed in here.

MENU 4.7 - HOLIDAY SETTING

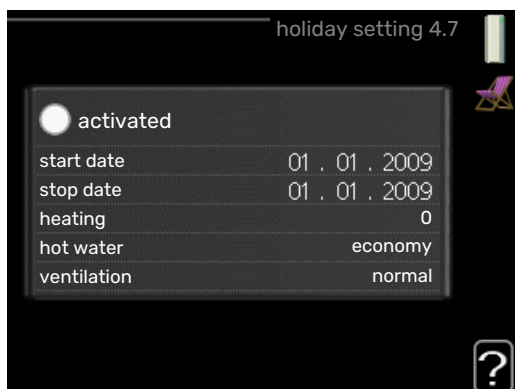

To reduce energy consumption during a holiday you can schedule a reduction in heating, ventilation and hot water temperature. Solar panel cooling can also be scheduled if the function is connected.

If a room sensor is installed and activated, the desired room temperature (°C) is set during the time period. This setting applies to all climate systems with room sensors.

If a room sensor is not activated, the desired offset of the heating curve is set. One step is usually enough to change the room temperature by one degree, but in some cases several steps may be required. This setting applies to all climate systems without room sensors.

The vacation scheduling starts at 00:00 on the start date and stops at 23:59 on the stop date.



TIP!

Stop the holiday setting about a day before your return so that room temperature and hot water have time to return to their usual levels.



TIP!

Set the vacation setting in advance and activate just before departure in order to maintain the comfort.



NOTE!

If the exhaust air temperature falls below 6 °C, the compressor is blocked and electric additional heat is permitted. No energy is recovered from the exhaust air, when the compressor is blocked.



NOTE!

The heat pump requires a minimum ventilation flow in order to work properly. An insufficient ventilation flow can result in an alarm and blocking of compressor operation.



NOTE!

In installations with water heaters without an immersion heater connected to F730 "hot water" should not be set to "off" when holiday setting is activated.

MENU 4.9 - ADVANCED

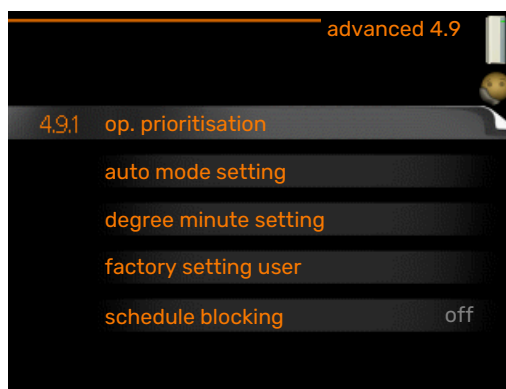

Menu **advanced** has orange text and is intended for the advanced user. This menu has several sub-menus.

MENU 4.9.1 - OP. PRIORITISATION

op. prioritisation

Setting range: 0 to 180 min

Default value: 30 min

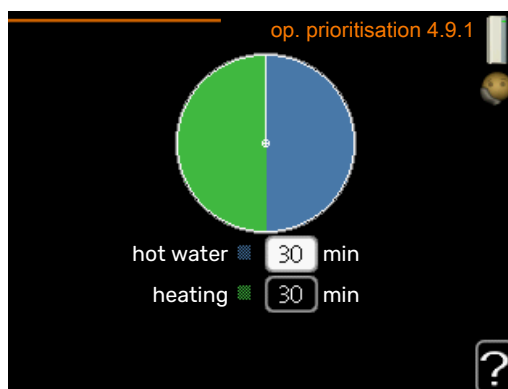

Choose here how long the heat pump should work with each requirement if there are two requirements at the same time. If there is only one requirement the heat pump only works with that requirement.

The indicator marks where in the cycle the heat pump is.

If 0 minutes is selected, this means that the requirement is not prioritised, but will only be activated when there is no other requirement.

MENU 4.9.2 - AUTO MODE SETTING

stop heating

Setting range: -20 – 40 °C

Default values: 17

stop additional heat

Setting range: -25 – 40 °C

Factory setting: 10

filtering time

Setting range: 0 – 48 h

Default value: 24 h

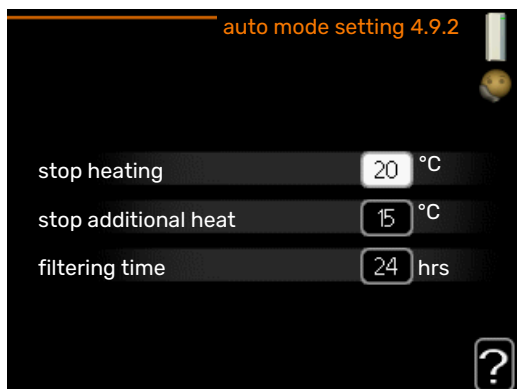

When the operating mode is set to "auto", the heat pump selects when start and stop of additional heat and heat production is permitted, dependent on the average outdoor temperature.

Select the average outdoor temperatures in this menu.

NOTE!

It cannot be set "stop additional heat" higher than "stop heating".

filtering time: You can also set the time (filtering time) over which the average temperature is calculated. If you select 0, the current outdoor temperature is used.

MENU 4.9.3 - DEGREE MINUTE SETTING

current value

Setting range: -3000 – 3000

start compressor

Setting range: -1000 – -30

Default value: -60

start diff additional heat

Setting range: 100 – 2000

Factory setting: 700

diff. between additional steps

Setting range: 0 – 1000

Factory setting: 50

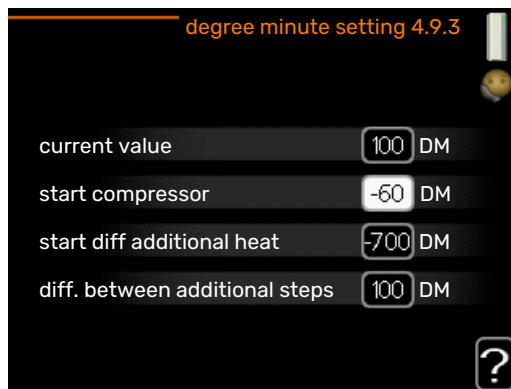

Degree minutes are a measurement of the current heating requirement in the house and determine when the compressor respectively additional heat will start/stop.

NOTE!

Higher value on "start compressor" gives more compressor starts, which increase wear on the compressor. Too low value can give uneven indoor temperatures.

MENU 4.9.4 - FACTORY SETTING USER

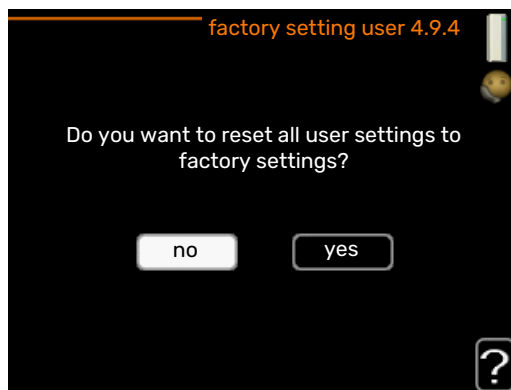

All settings that are available to the user (including advanced menus) can be reset to default values here.

NOTE!

After factory setting, personal settings such as heating curves, ventilation etc must be reset.

MENU 4.9.5 - SCHEDULE BLOCKING

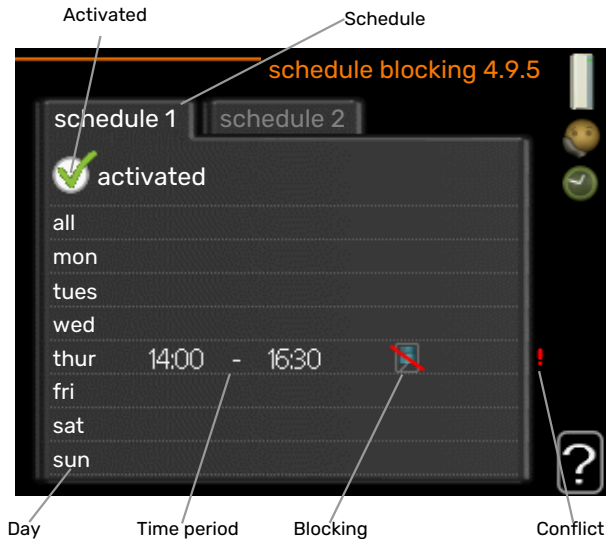

The compressor can be scheduled to be blocked for up to two different time periods here.

When scheduling is active the actual blocking symbol in the main menu on the heat pump symbol is displayed.

Schedule: The period to be changed is selected here.

Activated: Scheduling for the selected period is activated here. Set times are not affected at deactivation.

Day: Select which day or days of the week the scheduling is to apply to here. To remove the scheduling for a particular day, the time for that day must be reset by setting the start time to the same as the stop time. If the row "all" is used, all days in the period are set according to that row.

Time period: The start and stop time for the selected day for scheduling are selected here.

Blocking: The desired blocking is selected here.

Conflict: If two settings conflict with each other, a red exclamation mark is displayed.



Blocking the compressor.



Blocking additional heat.



TIP!

If you wish to set similar scheduling for every day of the week start by filling in "all" and then changing the desired days.



TIP!

Set the stop time earlier than the start time so that the period extends beyond midnight. Scheduling then stops at the set stop time the day after.

Scheduling always starts on the date that the start time is set for.



NOTE!

Long term blocking can cause reduced comfort and operating economy.

MENU 4.9.6 - SCHEDULE SILENT MODE

Here you can schedule whether the heat pump is to be set to "quiet mode" (the heat pump must support this) for up to two different time periods and two different max. frequencies. In this way, you can reduce the sound during the day and also reduce it further at night.

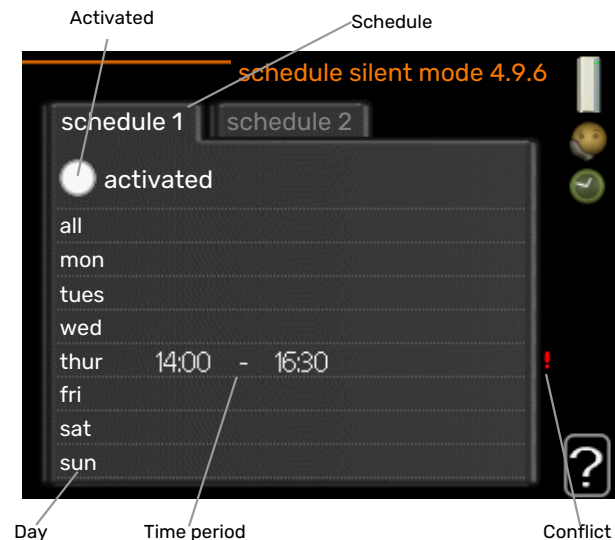

Schedule: The period to be changed is selected here.

Activated: Scheduling for the selected period is activated here. Set times are not affected at deactivation.

Day: Select which day or days of the week the scheduling is to apply to here. To remove the scheduling for a particular day, the time for that day must be reset by setting the start time to the same as the stop time. If the row "all" is used, all days in the period are set according to that row.

Time period: The start and stop time for the selected day for scheduling are selected here.

Conflict: If two settings conflict with each other, a red exclamation mark is displayed.



TIP!

If you wish to set similar scheduling for every day of the week start by filling in "all" and then changing the desired days.



TIP!

Set the stop time earlier than the start time so that the period extends beyond midnight. Scheduling then stops at the set stop time the day after.

Scheduling always starts on the date that the start time is set for.



NOTE!

Long term scheduling of "quiet mode" can cause reduced comfort and operating economy.

Disturbances in comfort

In most cases, the heat pump notes operational interference (operational interference can lead to disturbance in comfort) and indicates this with alarms and shows action instructions in the display.

Info menu

All the heat pump measurement values are gathered under menu 3.1 in the heat pump menu system. Looking through the values in this menu can often simplify finding the fault source. See page 23 for more information about menu 3.1.

Manage alarm

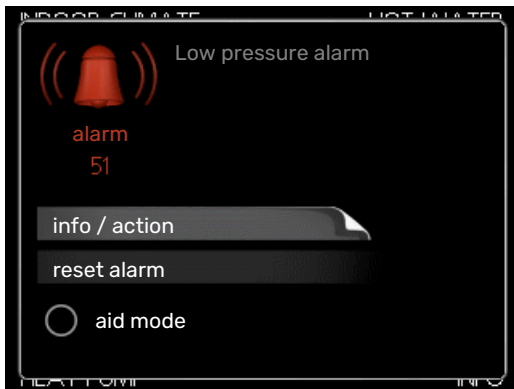

In the event of an alarm, some kind of malfunction has occurred, which is indicated by the status lamp changing from green continuously to red continuously. In addition, an alarm bell appears in the information window.

ALARM

In the event of an alarm with a red status lamp, a malfunction has occurred that the heat pump cannot remedy itself. By turning the control knob and pressing the OK button, you can see in the display what type of alarm it is and reset it. You can also choose to set the heat pump to aid mode.

info / action Here you can read what the alarm means and receive tips on what you can do to correct the problem that caused the alarm.

reset alarm In many cases, it is sufficient to select "reset alarm" in order for the product to revert to normal operation. If a green light comes on after selecting "reset alarm", the alarm has been remedied. If a red light is still visible and a menu called "alarm" is visible in the display, the problem causing the alarm still remains. If the alarm initially disappears and then returns, you should contact your installer.

aid mode "aid mode" is a type of emergency mode. This means that the heat pump produces heat and/or hot water even though there is some kind of problem. This could mean that the heat pump's compressor is not running. In this case, the immersion heater produces heat and/or hot water.



NOTE!

To select aid mode an alarm action must be selected in the menu 5.1.4.



NOTE!

Selecting "aid mode" is not the same as correcting the problem that caused the alarm. The status lamp will therefore continue to be red.

If the alarm does not reset, contact your installer for suitable remedial action.



NOTE!

You need the product's (14 digit) serial number for servicing and support.

See chapter "Important information", page 5.

Troubleshooting

If the operational interference is not shown in the display the following tips can be used:

BASIC ACTIONS

Start by checking the following items:

- The switch's position.
- Group and main fuses of the accommodation.
- The property's earth circuit breaker.
- Heat pump's earth-fault breaker.
- Miniature circuit breaker for F730 (FC1).

LOW HOT WATER TEMPERATURE OR A LACK OF HOT WATER

- Closed or throttled externally mounted filling valve for the hot water.
 - Open the valve.
- F730 in incorrect operating mode.
 - Enter menu 4.2. If mode "auto" is selected, select a higher value on "stop additional heat" in menu 4.9.2.
 - If mode "manual" is selected, select "addition".
- Large hot water consumption.
 - Wait until the hot water has heated up. Temporarily increased hot water capacity (temporary lux) can be activated in menu 2.1.
- Too low hot water setting.
 - Enter menu 2.2 and select a higher comfort mode.
- Too low or no operating prioritisation of hot water.

- Enter menu 4.9.1 and increase the time for when hot water is to be prioritised. Note that if the time for hot water is increased, the time for heating production is reduced, which can give lower/uneven room temperatures.
- The exhaust air filter is clogged.
 - Clean or replace the filter.

LOW ROOM TEMPERATURE

- Closed thermostats in several rooms.
 - Set the thermostats to max, in as many rooms as possible. Adjust the room temperature via menu 1.1, instead of choking the thermostats.

See the "Saving tips" section for more detailed information about how to best set the thermostats.

- F730 in incorrect operating mode.
 - Enter menu 4.2. If mode "auto" is selected, select a higher value on "stop heating" in menu 4.9.2.
 - If mode "manual" is selected, select "heating". If this is not enough, select "addition".
- Too low set value on the automatic heating control.
 - Enter menu 1.1 - "temperature" and adjust the offset heating curve up. If the room temperature is only low in cold weather, the curve slope in menu 1.9.1 - "heating curve" may need to be adjusted upwards.
- Too low or no operating prioritisation of heat.
 - Enter menu 4.9.1 and increase the time for when heating is to be prioritised. Note that if the time for heating is increased the time for hot water production is reduced, which can give smaller amounts of hot water.
- "comfort mode" "luxury" selected in combination with large hot water outlet.
 - When you have selected "comfort mode" "luxury", F730 prioritises hot water production over heat production. If you want to change comfort mode: Enter menu 2.2 and select "economy" or "normal".
- "Holiday mode" activated in menu 4.7.
 - Enter menu 4.7 and select "Off".
- External switch for changing room temperature activated.
 - Check any external switches.
- Air in the climate system.
 - Vent the climate system.
- Closed valves to the climate system.
 - Open the valves (contact your installer for assistance in finding them).
- The exhaust air filter is clogged.
 - Clean or replace the filter.

HIGH ROOM TEMPERATURE

- Too high set value on the automatic heating control.
 - Enter menu 1.1 - "temperature" and reduce the offset heating curve. If the room temperature is only high in cold weather, the curve slope in menu 1.9.1 - "heating curve" may need to be adjusted downwards.
- External switch for changing room temperature activated.
 - Check any external switches.

LOW SYSTEM PRESSURE

- Not enough water in the climate system.
 - Top up the water in the climate system.

LOW OR A LACK OF VENTILATION

- The exhaust air filter is clogged.
 - Clean or replace the filter.
- The ventilation is not adjusted.
 - Order ventilation adjustment.
- Exhaust air device blocked or throttled down too much.
 - Check and clean the exhaust air devices (see page 12).
- Fan speed in reduced mode.
 - Enter menu 1.2 and select "normal".
- External switch for changing the fan speed activated.
 - Check any external switches.

HIGH OR DISTRACTING VENTILATION

- The exhaust air filter is clogged.
 - Clean or replace the filter.
- The ventilation is not adjusted.
 - Order ventilation adjustment.
- Fan speed in forced mode.
 - Enter menu 1.2 and select "normal".
- External switch for changing the fan speed activated.
 - Check any external switches.

THE COMPRESSOR DOES NOT START

- There is no heating or hot water demand.
 - F730 does not call on heating or hot water.
- The heat pump defrosts.
 - The compressor starts, when defrosting is complete.
- Compressor blocked due to the temperature conditions.
 - Wait until the temperature is within the product's working range.
- Minimum time between compressor starts has not been reached.
 - Wait for at least 30 minutes and then check if the compressor has started.
- Alarm tripped.

- Follow the display instructions.

Technical data

Detailed technical specifications for this product can be found in the installation manual (nibe.eu).

Glossary

ADDITIONAL HEAT

The additional heat is the heat produced in addition to the heat supplied by the compressor in your heat pump. Additional heaters can be for example, immersion heater, electric heater, gas/oil/pellet/wood burner or district heating.

CALCULATED FLOW LINE TEMPERATURE

The temperature that the heat pump calculates that the heating system requires for an optimum accommodation temperature. The colder the outdoor temperature, the higher the calculated supply temperature.

CIRCULATION PUMP

Pump that circulates liquid in a pipe system.

CLIMATE SYSTEM

Climate systems can also be called heating systems. The building is heated using radiators, under floor coils or convector fans.

COMPRESSOR

Compresses the gas state refrigerant. When the refrigerant is compressed, the pressure and the temperature increase.

CONDENSER

Heat exchanger where the hot gas state refrigerant condenses (cooled and becomes a liquid) and releases heat energy to the house heating and hot water systems.

DISTURBANCES IN COMFORT

Disturbances in comfort are undesirable changes to the hot water/indoor comfort, for example when the temperature of the hot water is too low or if the indoor temperature is not at the desired level.

A malfunction in the heat pump can sometimes be noticed in the form of a disturbance in comfort.

In most cases, the heat pump notes operational interference and indicates this with alarms and shows instructions in the display.

DOMESTIC HOT WATER

The water one showers in for example.

ELECTRICAL ADDITION

This is the electricity that, for example, an immersion heater produces when the compressor's output is not sufficient to fulfil the property's heating demand.

EMERGENCY MODE

A mode that can be selected using the switch in the event of a fault, which means that the compressor stops. When the heat pump is in emergency mode, the building is heated using an immersion heater. Hot water is not produced.

EVAPORATOR

Heat exchanger where the refrigerant evaporates by retrieving heat energy from the air which then cools.

EXHAUST AIR

The air that comes from the exhaust air device in the various rooms of the accommodation, to F730.

EXHAUST AIR DEVICES

Vents, usually in the ceiling, in the kitchen/bathroom/clothes closet where the air is drawn in to be forwarded to F730.

EXPANSION VALVE

Valve that reduces the pressure of the refrigerant, whereupon the temperature of the refrigerant drops.

EXPANSION VESSEL

Vessel with fluid with the task of equalising the pressure in the system.

EXTRACT AIR

The air that the heat pump has retrieved heat from and which has therefore been cooled. This air is blown out of the building.

FILTERING TIME

Indicates the time the average outdoor temperature is calculated on.

FLOW PIPE

The line in which the heated water is transported from the heat pump out to the house heating system (radiators/heating coils).

HEAT EXCHANGER

Device that transfers heat energy from one medium to another without mixing mediums. Examples of different heat exchangers include evaporators and condensers.

HEAT FACTOR

Measurement of how much heat energy the heat pump gives off in relation to the electric energy it needs to operate. Another term for this is COP.

HEATING CURVE

The heating curve determines which heat the heat pump is to produce depending on the temperature outdoors. If a high value is selected, this tells the heat pump that it must produce a lot of heat when it is cold outdoors in order to achieve a warm indoor temperature.

HEATING MEDIUM

Hot liquid, usually normal water, which is sent from the heat pump to the house climate system and makes the accommodation warm. The heating medium also heats the hot water.

HEATING MEDIUM SIDE

Pipes to the house's climate system make up the heating medium side.

OUTDOOR AIR DAMPER

Intake for outdoor air.

OUTSIDE SENSOR

A sensor that is located outdoors. This sensor tells the heat pump how hot it is outdoors.

PRESSOSTAT

Pressure switch that triggers an alarm and/or stops the compressor if non-permitted pressures occur in the system. A high pressure pressostat trips if the condensing pressure is too great. A low pressure pressostat trips if the evaporation pressure is too low.

RADIATOR

Another word for heating element. They must be filled with water in order to be used with F730.

REFRIGERANT

Substance that circulates around a closed circuit in the heat pump and that, through pressure changes, evaporates and condenses. During evaporation, the refrigerant absorbs heating energy and when condensing gives off heating energy.

RETURN PIPE

The line in which the water is transported back to the heat pump from the house heating system (radiators/heating coils).

RETURN TEMP

The temperature of the water that returns to the heat pump after releasing the heat energy to the radiators/heating coils.

ROOM SENSOR

A sensor that is located indoors. This sensor tells the heat pump how hot it is indoors.

SAFETY VALVE

A valve that opens and releases a small amount of liquid if the pressure is too high.

SUPPLY TEMPERATURE

The temperature of the heated water that the heat pump sends out to the heating system. The colder the outdoor temperature, the higher the supply line temperature becomes.

WATER HEATER

Container where domestic water is heated. Is located inside the heat pump, but an extra hot water heater can be installed in the event of large hot water requirements.

Item register

- A**
 - Adjust the heat pump, 25
 - Alarm, 34
- B**
 - Back button, 8
- C**
 - Contact with F730, 8
 - Display unit, 8
 - External information, 8
 - Menu system, 9
 - Control knob, 8
- D**
 - Display, 8
 - Display unit, 8
 - Back button, 8
 - Control knob, 8
 - Display, 8
 - OK button, 8
 - Status lamp, 8
 - Switch, 8
 - Disturbances in comfort, 34
 - Alarm, 34
 - Manage alarm, 34
 - Troubleshooting, 34
- E**
 - External information, 8
 - Information window, 8
 - Status lamp, 8
- F**
 - F730 – at your service, 15
 - Adjust the heat pump, 25
 - Get information, 23
 - Set the hot water capacity, 21
 - Set the indoor climate, 15
- G**
 - Get information, 23
 - Glossary, 38
- H**
 - Heat pump function, 7
 - Help menu, 11
- I**
 - Important information
 - Installation data, 4
 - Serial number, 5
 - Information window, 8
 - Installation data, 4
- M**
 - Maintenance of F730, 12
 - Regular checks, 12
 - Saving tips, 14
 - Manage alarm, 34
 - Menu system, 9
 - Help menu, 11
 - Operation, 10
 - Scroll through the windows, 11
 - Selecting menu, 10
 - Selecting options, 10
 - Setting a value, 10
 - Use the virtual keyboard, 11
- O**
 - OK button, 8
 - Operation, 10
- P**
 - Power consumption, 14
- R**
 - Regular checks, 12
 - Replacing exhaust air filter, 12
 - Exhaust air filter, 12
- S**
 - Saving tips, 14
 - Power consumption, 14
 - Scroll through the windows, 11
 - Selecting menu, 10
 - Selecting options, 10
 - Serial number, 5
 - Set the hot water capacity, 21
 - Set the indoor climate, 15
 - Setting a value, 10
 - Status lamp, 8
 - Switch, 8
- T**
 - Technical data, 37
 - The heat pump – the heart of the house, 7
 - Troubleshooting, 34
- U**
 - Use the virtual keyboard, 11

Contact information

AUSTRIA

KNV Energietechnik GmbH
Gahberggasse 11, 4861 Schörfling
Tel: +43 (0)7662 8963-0
mail@knv.at
knv.at

FINLAND

NIBE Energy Systems Oy
Juurakkotie 3, 01510 Vantaa
Tel: +358 (0)9 274 6970
info@nibe.fi
nibe.fi

GREAT BRITAIN

NIBE Energy Systems Ltd
3C Broom Business Park,
Bridge Way, S41 9QG Chesterfield
Tel: +44 (0)330 311 2201
info@nibe.co.uk
nibe.co.uk

POLAND

NIBE-BIAWAR Sp. z o.o.
Al. Jana Pawla II 57, 15-703 Białystok
Tel: +48 (0)85 66 28 490
biawar.com.pl

CZECH REPUBLIC

Družstevní závody Dražice - strojírna
s.r.o.
Dražice 69, 29471 Benátky n. Jiz.
Tel: +420 326 373 801
nibe@nibe.cz
nibe.cz

FRANCE

NIBE Energy Systems France SAS
Zone industrielle RD 28
Rue du Pou du Ciel, 01600 Reyrieux
Tél: 04 74 00 92 92
info@nibe.fr
nibe.fr

NETHERLANDS

NIBE Energietechnik B.V.
Energieweg 31, 4906 CG Oosterhout
Tel: +31 (0)168 47 77 22
info@nibenl.nl
nibenl.nl

SWEDEN

NIBE Energy Systems
Box 14
Hannabadsvägen 5, 285 21 Markaryd
Tel: +46 (0)433-27 30 00
info@nibe.se
nibe.se

DENMARK

Vølund Varmeteknik A/S
Industrivej Nord 7B, 7400 Herning
Tel: +45 97 17 20 33
info@volundvt.dk
volundvt.dk

GERMANY

NIBE Systemtechnik GmbH
Am Reiherpfahl 3, 29223 Celle
Tel: +49 (0)5141 75 46 -0
info@nibe.de
nibe.de

NORWAY

ABK-Qviller AS
Brobekkeveien 80, 0582 Oslo
Tel: (+47) 23 17 05 20
post@abkqviller.no
nibe.no

SWITZERLAND

NIBE Wärmetechnik c/o ait Schweiz AG
Industriepark, CH-6246 Altishofen
Tel. +41 (0)58 252 21 00
info@nibe.ch
nibe.ch

For countries not mentioned in this list, contact NIBE Sweden or check nibe.eu for more information.

NIBE Energy Systems
Hannabadsvägen 5
Box 14
SE-285 21 Markaryd
info@nibe.se
nibe.eu

UHB EN 2405-1 M13352

This is a publication from NIBE Energy Systems. All product illustrations, facts and data are based on the available information at the time of the publication's approval.

NIBE Energy Systems makes reservations for any factual or printing errors in this publication.

©2024 NIBE ENERGY SYSTEMS

