



Ground source heat pump

NIBE F1345

NIBE F1345 is a powerful, flexible ground source heat pump which is available in the output sizes 24, 30, 40 and 60 kW. Up to nine NIBE F1345s can be combined in a single system to cover output requirements of up to 540 kW.

NIBE F1345 has a high seasonal performance factor, and with less than 5 tonnes CO₂ equivalent refrigerant volume per compressor module, NIBE F1345 does not require annual inspection. Two large compressors make NIBE F1345 perfect for properties with larger heating requirements. The compressors are switched on and off automatically for better output regulation, a longer operating range, less wear and tear and improved reliability.

Thanks to smart technology, the product gives you control over your energy consumption and will be a key part of your connected lifestyle. The efficient control system automatically adjusts the indoor climate for maximum comfort, and you do nature a favour at the same time.

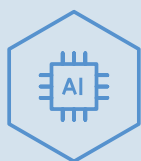

- **Powerful, flexible system that covers output requirements of up to 540 kW.**
- **Reliable system with efficient output regulation and no requirement for annual inspection.**
- **Smart technology with user-friendly control for optimal remote control.**

This is how F1345 works

Installation method

Rock

F1345 collects a proportion of the rock's stored solar energy via a collector in a borehole in the rock.

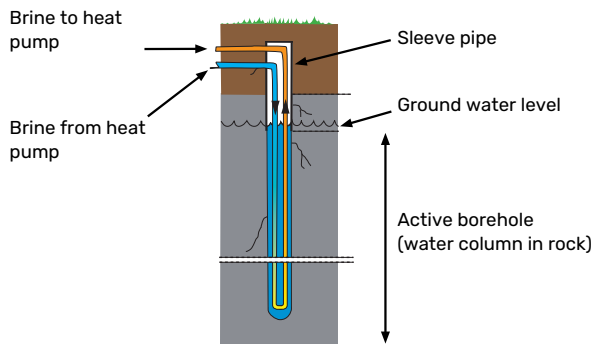
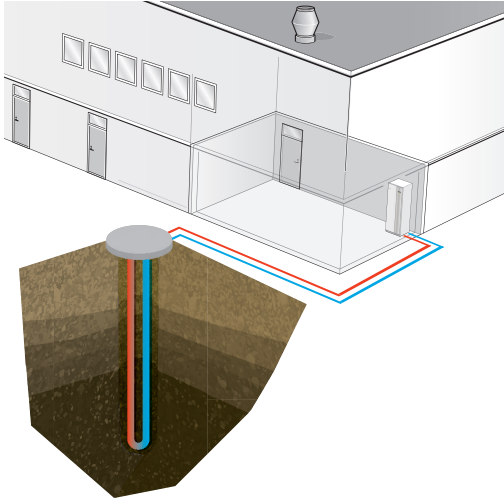

Ground

F1345 collects a proportion of the ground's stored solar energy via a buried ground collector.

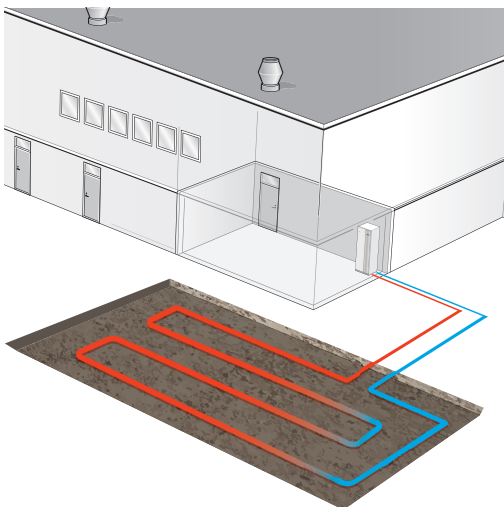

Lake

F1345 collects a proportion of the water's stored solar energy via a lake collector that is anchored on the lake bed.

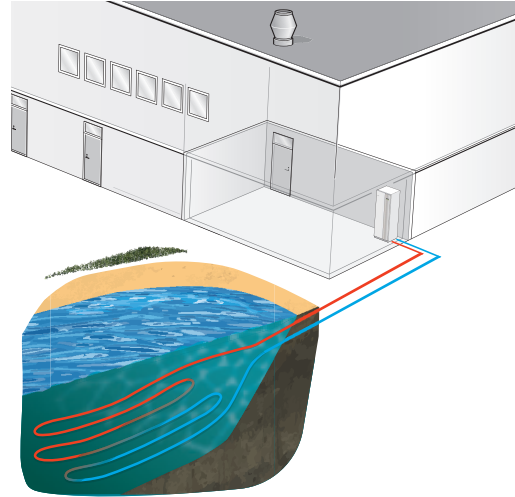

Ventilation recovery

F1345 collects energy from the ventilation air via an air conditioning unit.

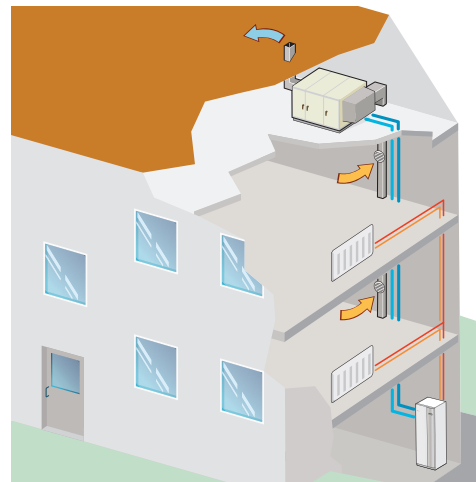

Design

F1345 is constructed on a robust frame with durable panels and effective soundproofing for the best possible comfort. All panels are easy to remove to facilitate installation and for any servicing.

Principle of operation

F1345 consists of two cooling modules, circulation pumps and control system with the option for additional heating, where applicable. F1345 is connected to the brine and heating medium circuits.

In the heat pump evaporator, the brine (water mixed with anti-freeze, glycol or ethanol) releases its energy to the refrigerant, which is vaporised in order to be compressed in the compressor. The refrigerant, of which the temperature has now been raised, is passed to the condenser where it gives off its energy to the heating medium circuit and, if necessary, to any docked water heater. If there is a greater need for heating/hot water than the compressors can provide it is possible to connect an external immersion heater.

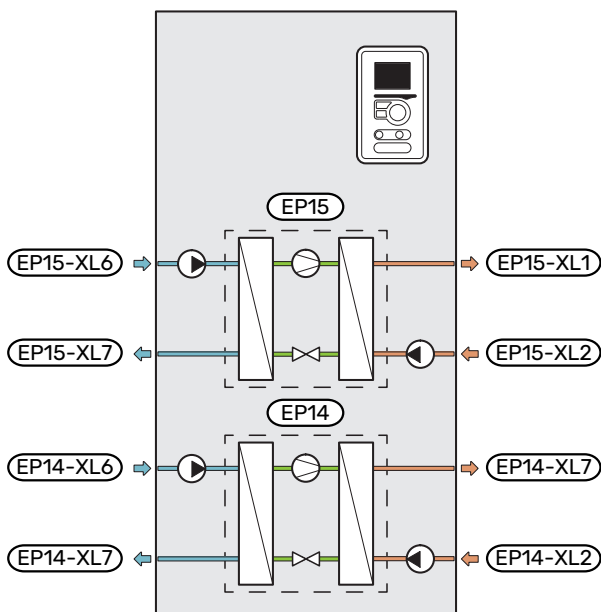

EP14	Cooling module
EP15	Cooling module
XL1	Connection, heating medium flow
XL2	Connection, heating medium return
XL6	Connection, brine in
XL7	Connection, brine out

Good to know about F1345

Transport and storage

F1345 should be transported and stored vertically in a dry place. When being moved into a building, F1345 may be leant back 45 °.

The product can be tail heavy.

If the cooling modules are pulled out and transported up-right, F1345 can be transported on its back.

Remove the outer panels in order to protect them when moving in confined spaces inside buildings.

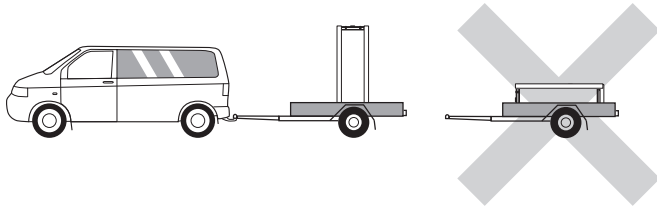

EXTRACTING THE COOLING MODULES

To simplify transport and service, the heat pump can be separated by pulling the cooling modules out from the cabinet.

See section "Service" in the Operating Manual for comprehensive instructions about the separation.

Installation and positioning

- Position F1345 on a solid foundation indoors that withstands water and the weight of the product.
- Since water comes from F1345, the area where F1345 is located must be equipped with floor drainage.
- Install with its back to an outside wall, ideally in a room where noise does not matter, in order to eliminate noise problems. If this is not possible, avoid placing it against a wall behind a bedroom or other room where noise may be a problem.
- Wherever the unit is located, walls to sound sensitive rooms should be fitted with sound insulation.

INSTALLATION AREA

Leave a free space of 800 mm in front of, and 150 mm above, the product. Approx. 50 mm free space is required on each side to allow the side panels to be removed. All service on F1345 can be carried out from the front, however the right-hand panel may need to be removed. Leave free space between the heat pump and the wall behind (and any routing of supply cables and pipes), to reduce the risk of any vibrations being propagated.

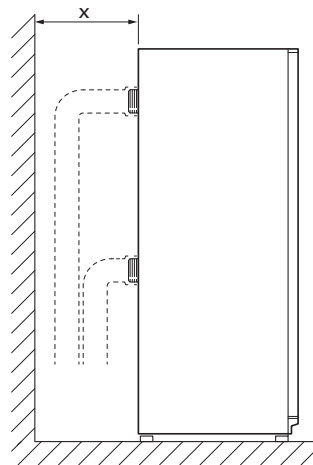

x Leave the required space for pipe installation.

Supplied components

Local differences in the enclosed kit may occur. See relevant installer manual for more information.

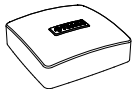

Outdoor temperature sensor
1 pcs



Temperature sensor
5 pcs

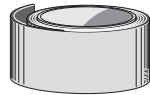

Insulation tape
1 pcs



Aluminium tape
1 pcs



Heat conduction paste
3 pcs

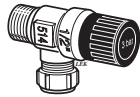

Safety valve
0.3 MPa (3 bar)
1 pcs



O-rings
16 pcs



Current sensor
(not 60 kW)
3 x



Tubes for sensors
4 pcs

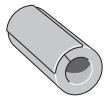

Pipe insulation
8 pcs

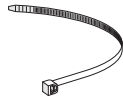

Cable ties
8 pcs



Non-return valves
24 - 30 kW: 4 pcs
G2 (internal thread)
40 - 60 kW: 2 pcs
G2 (internal thread)



Particle filter
24 - 30 kW: 4 x G1
1/2 (internal thread)
40 - 60 kW: 2 x G1
1/2 (internal thread), 2 x G2 (internal thread)



Brine pump
(only for 40 and
60 kW)
1 pcs

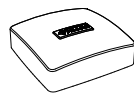

IPA 10
(only for 40 and
60 kW)
1 pcs

LOCATION

The enclosed kit is placed in the packaging next to the heat pump.

Installation

Inspection of the installation

Current regulations require the heating installation to be inspected before it is commissioned. The inspection must be carried out by a suitably qualified person.

Pipe installation

Pipe installation must be carried out in accordance with current standards and directives. F1345 can operate with a return temperature of up to 58 °C and an outgoing temperature of 65 °C.

F1345 is not equipped with internal shut-off valves; instead, these should be installed to facilitate any future servicing. In addition, non-return valves and particle filters must be fitted.

The pipe connections are on the rear of the heat pump.

Water may drip from the safety valve's overflow pipe. The overflow pipe must be routed to a suitable drain, to prevent hot water splashes from causing harm. The overflow pipe must be inclined along its entire length to prevent pockets where water can accumulate, and must be frost-proof. The overflow pipe must be at least the same size as the safety valve. The overflow pipe must be visible and its mouth must be open and not placed close to electrical components.

BRINE



The brine transports energy from a source to the heat pump using a liquid consisting of water mixed with antifreeze. The brine must be mixed to ensure that the freezing point is lower than -15 °C.

Expansion vessel

The brine circuit must be supplied with a pressure expansion vessel.

The brine side must be pressurised to at least 0.05 MPa (0.5 bar).

Dimension the pressure expansion vessel in accordance with the following diagram to prevent malfunctions. The diagrams cover the temperature range from -10 °C to +20 °C at pre-pressure 0.05 MPa (0.5 bar) and the safety valve's opening pressure of 0.3 MPa (3.0 bar).

Ethanol 28% (volume percent)

In installations with ethanol (28% volume percent) as the brine the pressure expansion vessel must be dimensioned according to the following diagram.

Volume pressure expansion vessel (l)

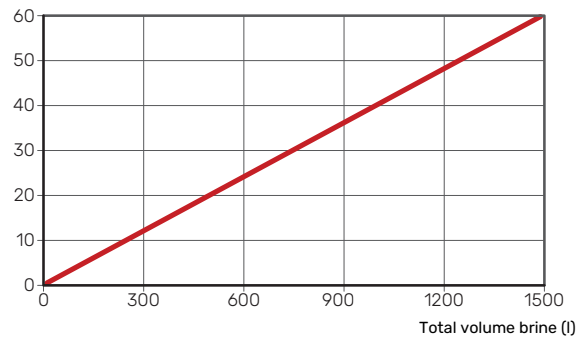

Ethylene glycol 40% (volume percent)

In installations with ethylene glycol (40% volume percent) as the brine the pressure expansion vessel must be dimensioned according to the following diagram.

Volume pressure expansion vessel (l)

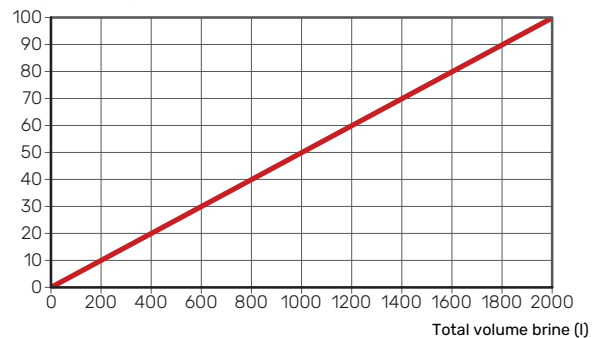

Connecting external brine pump (40 and 60 kW only)

Install the brine pump at the connection for incoming brine and between the heat pump and shut-off valve.

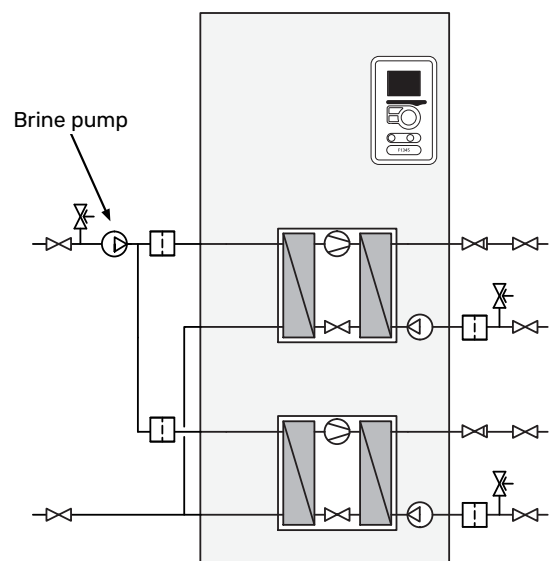

CLIMATE SYSTEM



A climate system is a system that regulates the indoor temperature with the help of the control system in F1345 and, for example, radiators, underfloor heating/cooling, fan coils, etc.

- Install the necessary safety equipment and shut-off valves (installed as close to F1345 as possible so that the flow to individual cooling modules can be shut off).
- Fit the enclosed particle filter on the incoming pipe.
- The safety valve must have a maximum 0.6 MPa (6.0 bar) opening pressure and be installed on the heating medium return. The entire length of the overflow water pipe from the safety valve must be inclined, to prevent water pockets and must also be frost-free.
- When connecting to a system with thermostats on all radiators, a relief valve must be fitted, or some of the thermostats must be removed to ensure sufficient flow.
- Fit the supplied non-return valves on the outgoing pipe.

When necessary you should install vent valves in the climate system.

F1345 is designed so that heating production can be performed using one or two cooling modules. However, this entails different pipe or electrical installations.

COLD AND HOT WATER



Any docked hot water heater must be fitted with necessary set of valves.

-
- A mixer valve must also be installed, if the factory setting for hot water is changed. National regulations must be observed.
- The safety valve must have max. 1.0 MPa (10.0 bar) opening pressure, and be installed on the incoming domestic water line.

Ensure that incoming water is clean. When using a private well, it may be necessary to supplement with an extra water filter.

For more information see nibe.eu.

Guideline values for collectors

The length of the collector hose varies depending on the rock/soil conditions, climate zone and on the climate system (radiators or underfloor heating) and the heating requirement of the building. Each installation must be sized individually.

Max. length per coil for the collector should not exceed 500 m.

The collectors must always be connected in parallel with the possibility of adjusting the flow for the relevant coil.

For surface soil heat, the hose should be buried at a depth determined by local conditions and the distance between the hoses should be at least 1 metre.

For several bore holes, the distance between the holes must be determined according to local conditions.

Ensure the collector hose rises constantly towards the heat pump to avoid air pockets. If this is not possible, airvents should be used.

Because the temperature of the brine system may fall below 0 °C, it must be protected against freezing down to -15 °C. When making the volume calculation, 1 litres of ready mixed brine per metre of collector hose (applies when using PEM-hose 40x2.4 PN 6.3) is used as a guide value.

Installation alternative



F1345 is a flexible product with advanced control equipment and can be adapted to several different system solutions. It is possible to combine F1345 with hot water heating, extra additional heating, ventilation recovery, cooling, etc.

The example below shows F1345 together with hot water heating and step controlled additional heat. Contact your NIBE dealer for more information about how to construct your installation.

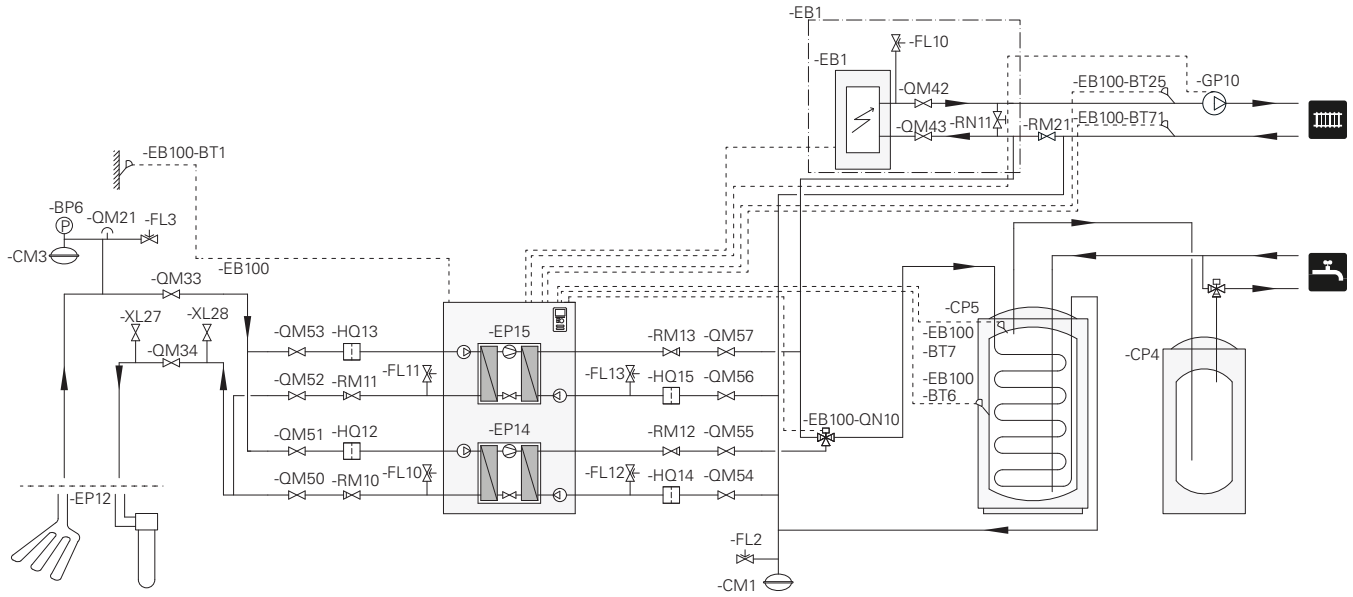

Functions

Control, general

The indoor temperature depends on several different factors. Sunlight and heat emissions from people and household machines are normally sufficient to keep the house warm during the warm seasons. When it gets colder outside, the climate system needs to help heat the house. The colder it is outside, the warmer radiators and underfloor heating systems have to be.

The heat pump is controlled by built-in supply and return brine temperature sensors (collector). Brine return temperatures can, if necessary, be limited to a minimum e.g. for ground water systems.

Control of the heat production is performed based on the "floating condensing" principle, which means that the temperature level needed for heating at a specific outdoor temperature is produced based on collected values from the outdoor and supply temperature sensors. The room sensor can also be used to compensate the deviation in room temperature.

Heat production



The supply of heat to the house is regulated in accordance with the heating curve selected setting. After adjustment, the correct amount of heat for the current outdoor temperature is supplied. The supply temperature will oscillate around the theoretically desired value.

Heat production can take place using one or several compressors.

OWN CURVE

F1345 has pre-programmed non-linear heating curves. It is also possible to create your own defined curve. This is an individual linear curve with a number of break points. You select break points and the associated temperatures.

Hot water production



This function requires the accessories VST 11 or VST 20.

If the water heater is docked to F1345 and there is a hot water demand, the heat pump's software control prioritizes the hot water charging mode with optimal heat pump power. Heating is produced by the second compressor in this mode.

Hot water charging starts when the temperature has fallen to the set start temperature. Hot water charging stops when the hot water temperature at the hot water sensor has been reached.

For temporary higher hot water demand, there is a function that allows the temperature to be raised temporarily for up to 12 hours or by a one time increase (can be selected in the menu system).

It is also possible to set F1345 in holiday mode, which means that the lowest possible temperature is achieved without the risk of freezing.

Master/slave



Multiple heat pumps can be interconnected, by selecting one of the heat pumps as the master and the others as slaves. Ground source heat pump models with master/slave functionality from NIBE can be connected to F1345.

The heat pump is always delivered as master and up to till 8 slaves can be connected to it. In systems with several heat pumps, each pump must have a unique name, i.e. only one heat pump can be "Master" and only one can be e.g. "Slave 5".

External temperature sensors and control signals must be connected solely to the master, except for external control of the compressor module and reversing valve(s) that can be connected one to each heat pump.

Additional heat only



If F1345 is docked to external additional heat, the installation can be used exclusively with additional heat to produce heating and hot water, for example, before the collector installation is complete.

Alarm indications



The status lamp lights red in the event of an alarm and the display shows detailed information depending on the fault. An alarm log is created with each alarm containing a number of temperatures, times and operating status.

Floor drying



F1345 has an integrated underfloor drying function. This allows for controlled drying of concrete slabs. It is possible to create your own program or to follow a pre-programmed time and temperature schedule. External additional heat is required to activate the function.

myUplink



With myUplink you can control the installation – where and when you want. In the event of any malfunction, you receive an alarm directly to your e-mail or a push notification to the myUplink app, which allows you to take prompt action.

Visit myuplink.com for more information.

SPECIFICATION

You need the following in order for myUplink to be able to communicate with your F1345:

- network cable
- Internet connection
- account on myuplink.com

We recommend our mobile apps for myUplink.

RANGE OF SERVICES

myUplink gives you access to various levels of service. The base level is included and, apart from this, you can choose two premium services for a fixed annual fee (the fee varies depending on the functions selected).

Service level	Basic	Premium extended history	Premium change settings
Viewer	X	X	X
Alarm	X	X	X
History	X	X	X
Extended history	-	X	-
Manage	-	-	X

MOBILE APPS FOR MYUPLINK

The mobile apps can be downloaded free of charge from where you usually download your mobile apps. Logging into the mobile app is performed using the same account details as on myuplink.com.

NIBE SMART PRICE ADAPTION™



Smart Price Adaption is not available in all countries. Contact your NIBE dealer for more information.

Smart Price Adaption adjusts the system's consumption according to the time of day when electricity prices are lowest. This allows for savings, provided that an hourly rate subscription has been signed with the electricity supplier.

The function is based on hourly rates for the coming day being downloaded via myUplink. To use the function, an Internet connection and account on myUplink are necessary.

The display



F1345 is controlled using a clear and easy to use display.

Instructions, settings and operational information are shown on the display. You can easily navigate between the different menus and options to set the comfort or obtain the information you require.

The display unit is equipped with a USB socket that can be used to update the software and save logged information in F1345.

Visit myuplink.com and click the "Software" tab to download the latest software for your installation.

Extended functions

Visit nibe.eu for further information about which functions are possible with F1345.

POOL



Up to two different pool systems can be connected to F1345 and controlled individually; however, this requires two POOL 40- or AXC accessories.

During pool heating, the heating medium is circulated between the heat pump and the pool exchanger using the heat pump's internal circulation pumps.

EXTRA CLIMATE SYSTEM



Up to seven extra climate systems can be connected to F1345. These can be configured for either heating or cooling. This function requires the accessory ECS 40/ECS 41 or AXC 50 if larger separate shunt valves are needed.

COOLING



The F1345, along with accessories, can distribute cooling to the climate system. The following cooling functions require the accessory AXC 50:

- Passive cooling in 4 pipe system
- Passive cooling in 2 pipe system
- Passive/active cooling in 2 pipe system

The following function requires the accessory ACS 45:

- Passive/active cooling in 4 pipe system

Technical data

Dimensions and pipe connections

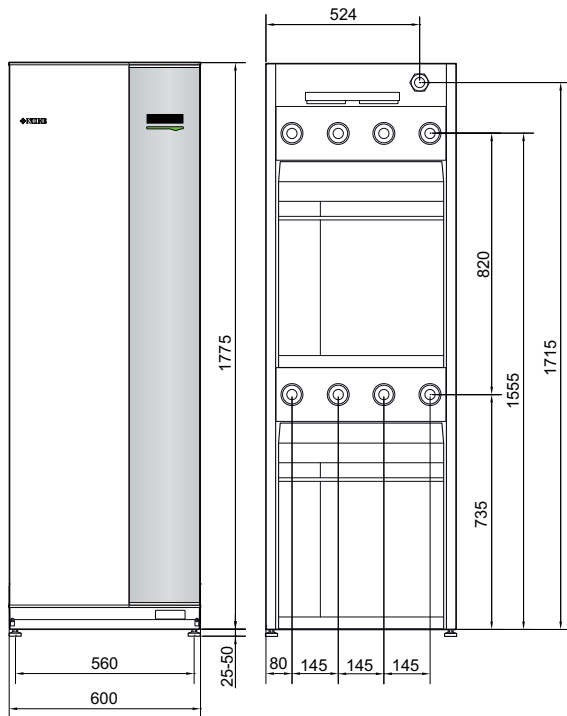

Enclosed brine pump (GP16) 60 kW

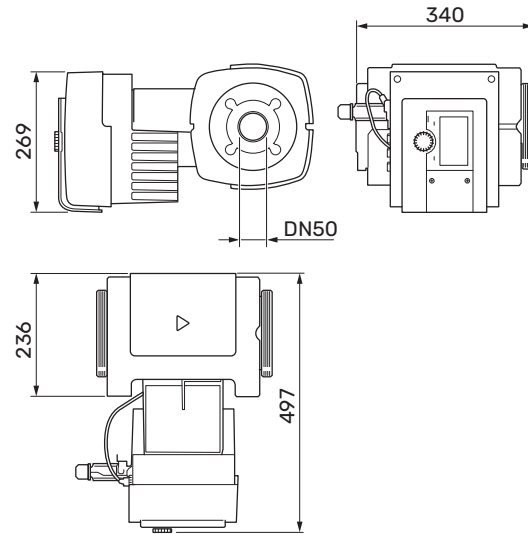

Enclosed brine pump (GP16) 40 kW

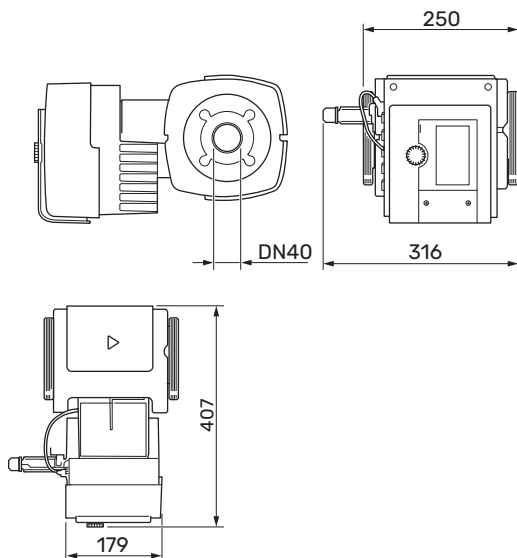

Pipe connections

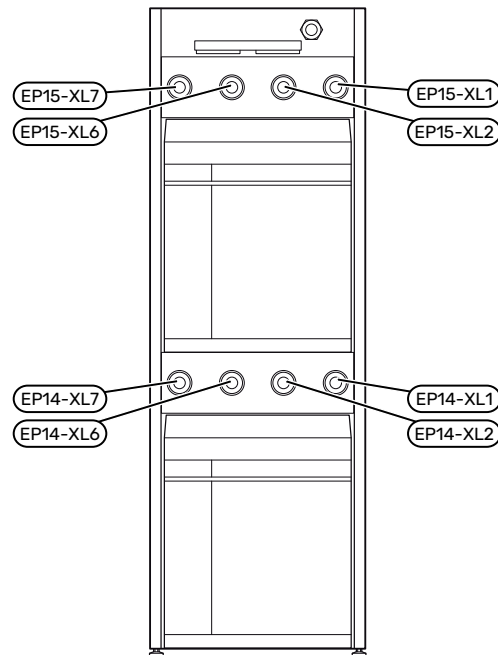

Connection	
(XL1) Heating medium supply	internal thread G 1½ external thread G2
(XL2) Heating medium return	internal thread G 1½ external thread G2
(XL6) Brine in	internal thread G 1½ external thread G2
(XL7) Brine out	internal thread G 1½ external thread G2
(GP16) brine pump 40 kW	compression ring coupling Ø 42mm
(GP16) brine pump 60 kW	compression ring coupling Ø 54mm

Technical specifications

Model		24	30	40	60
Output data according to EN 14511					
0/35					
Heating capacity (P _H)	kW	23.00	30.72	39.94	59.22
Supplied power (P _E)	kW	4.94	6.92	8.90	13.72
COP	-	4.65	4.44	4.49	4.32
0/45					
Heating capacity (P _H)	kW	21.98	29.74	38.90	56.12
Supplied power (P _E)	kW	5.96	8.34	10.61	16.02
COP	-	3.69	3.57	3.67	3.50
10/35					
Heating capacity (P _H)	kW	30.04	40.08	51.71	78.32
Supplied power (P _E)	kW	5.30	7.24	9.81	15.08
COP	-	5.67	5.53	5.27	5.19
10/45					
Heating capacity (P _H)	kW	29.28	39.16	50.79	74.21
Supplied power (P _E)	kW	6.34	8.84	11.82	17.60
COP	-	4.62	4.43	4.30	4.22
Output data according to EN 14825					
P _{designh} , 35 °C / 55 °C	kW	28	35	46	67
SCOP cold climate, 35 °C / 55 °C	-	5.0 / 4.0	4.9 / 3.8	5.0 / 3.9	4.7 / 3.8
SCOP average climate, 35 °C / 55 °C	-	4.8 / 3.8	4.7 / 3.6	4.8 / 3.8	4.6 / 3.7
Energy rating, average climate					
The product's room heating efficiency class 35 °C / 55 °C ¹	-	A+++ / A++	A+++ / A++	A+++ / A++	A+++ / A++
The system's room heating efficiency class 35 °C / 55 °C ²	-	A+++ / A++	A+++ / A++	A+++ / A++	A+++ / A++
Electrical data					
Rated voltage	-	400V 3N - 50Hz			
Max operating current, heat pump ³	A _{rms}	20.5	25.3	29.5	44.3
Max operating current per compressor	A _{rms}	8.4	11.1	13.1	19.9
Recommended fuse rating	A	25	30	35	50
Starting current	A _{rms}	29	30	42	53
Max permitted impedance at connection point ⁴	ohm	-	-	-	0.4
Total output, Brine pumps ³	W	6 - 360	6 - 360	15 - 640	20 - 1,500
Total output, HM pumps	W	5 - 174	5 - 174	5 - 174	5 - 174
Enclosure class	-	IP 21			
Refrigerant circuit					
Type of refrigerant	-	R407C	R407C	R407C	R410A
Volume	kg	2 x 2.0	2 x 2.0	2 x 1.7	2 x 1.7
GWP refrigerant	-	1,774	1,774	1,774	2,088
CO ₂ equivalent	ton	2 x 3.55	2 x 3.55	2 x 3.02	2 x 3.55
Brine circuit					
Max system pressure brine	MPa	0.6 (6 bar)	0.6 (6 bar)	0.6 (6 bar)	0.6 (6 bar)
Min flow	l/s	0.92	1.23	1.59	2.36
Nominal flow	l/s	1.18	1.62	2.09	3.10
Max external available press at nominal flow ⁵	kPa	92	75	105	65
Min/Max incoming Brine temp	°C	see diagram			
Min. outgoing brine temp.	°C	-12	-12	-12	-12
Heating medium circuit					
Max system pressure heating medium	MPa	0.6 (6 bar)	0.6 (6 bar)	0.6 (6 bar)	0.6 (6 bar)
Min flow	l/s	0.37	0.50	0.64	0.92
Nominal flow	l/s	0.54	0.73	0.93	1.34
Max external avail. pressure at nominal flow	kPa	78	72	70	50
Min/max HM-temp	°C	see diagram			
Noise					
Sound power level (L _{WA}) according to EN 12102 at 0/35	dB(A)	47	47	47	47
Sound pressure level (L _{PA}) calculated values according to EN ISO 11203 at 0/35 and 1 m range	dB(A)	32	32	32	32
Pipe connections					
Brine diam. CU pipe	-	G50 (2" external) / G40 (1 1/2" internal)			

Model		24	30	40	60
Heating medium diam. CU pipes	-	G50 (2" external) / G40 (1 1/2" internal)			
Compressor oil					
Oil type	-	POE			
Volume	l	2 x 1.9	2 x 1.1	2 x 1.9	2 x 1.9
Dimensions and weight					
Width	mm	600			
Depth	mm	620			
Height	mm	1,800			
Required ceiling height ⁶	mm	1,950			
Weight complete heat pump	kg	320	330	345	346
Weight only cooling module	kg	130	135	144	144
Part no. 3x400V ³		065 297	065 298	065 299	065 300
Part no. 3x400V ⁷				065 301	065 302

1 Scale for the product's efficiency class room heating: A+++ to D.

2 Scale for the system's efficiency class room heating: A+++ to G. Reported efficiency for the system takes the product's temperature regulator into account.

3 F1345-24 and 30 kW with internal brine pump. 40 and F1345-60 kW with enclosed brine pump.

4 Max permitted impedance in the mains connection point in accordance with EN 61000-3-11. Start currents can cause short voltage dips that may affect other equipment in unfavourable conditions. If the impedance in the mains connection point is higher than that stated, it is probable that interference will occur. If the impedance in the mains connection point is higher than that stated, check with the power supplier before purchasing the equipment.

5 This technical specification applies to the enclosed brine pump.

6 With feet removed, the height is approx. 1930 mm.

7 Including brine pump.

WORKING RANGE HEAT PUMP, COMPRESSOR OPERATION

The compressor provides a supply temperature up to 65 °C.

F1345-24 kW

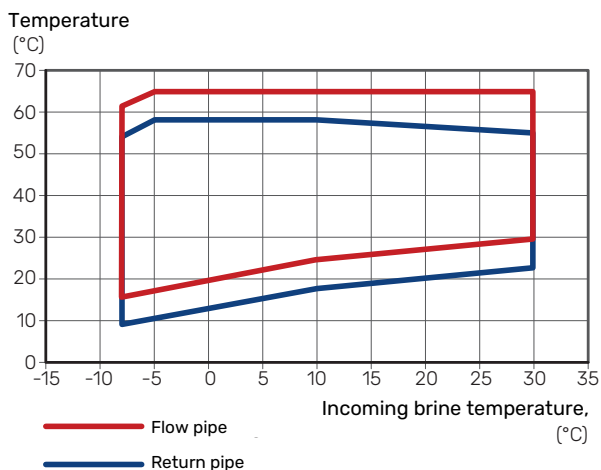

F1345-30 kW, 40 kW, 60 kW

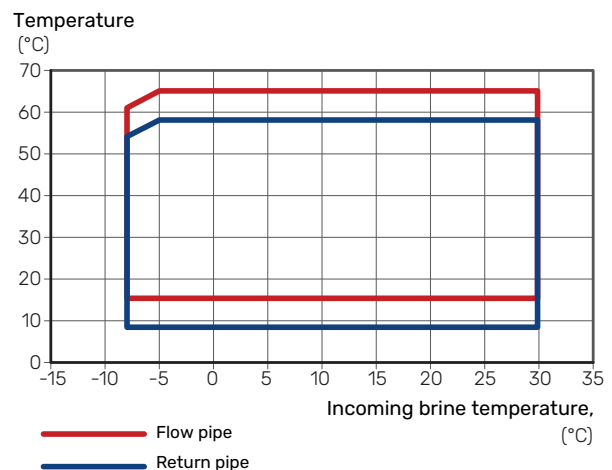

DIAGRAM, INTERNAL PRESSURE DROP

Diagram for sizing the brine pump for F1345.

F1345-40 kW and 60 kW

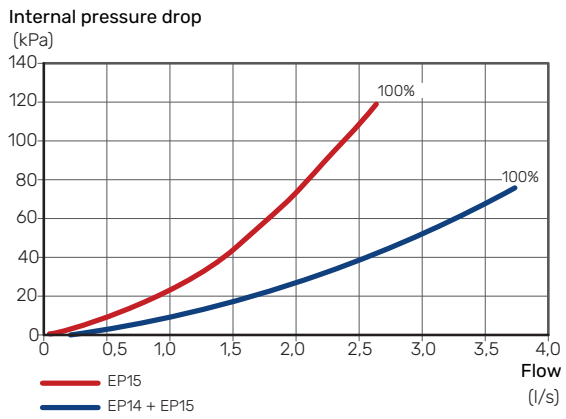

PUMP CAPACITY DIAGRAM

Brine side

To set the correct flow in the brine system, the brine pump must run at the correct speed. F1345 has a brine pump that is controlled automatically in standard mode.

For optimum operation when several heat pumps are installed in a multi-installation, all heat pumps should have the same compressor size.

— 1 circulation pump
 - - 2 circulation pumps

F1345 24 kW

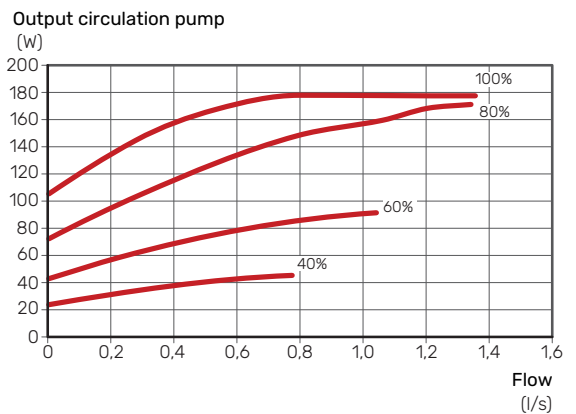
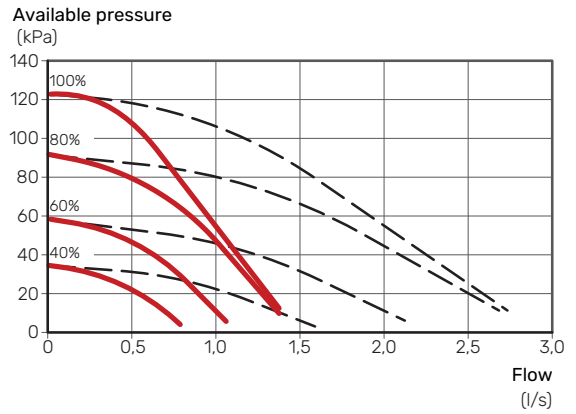

F1345 30 kW

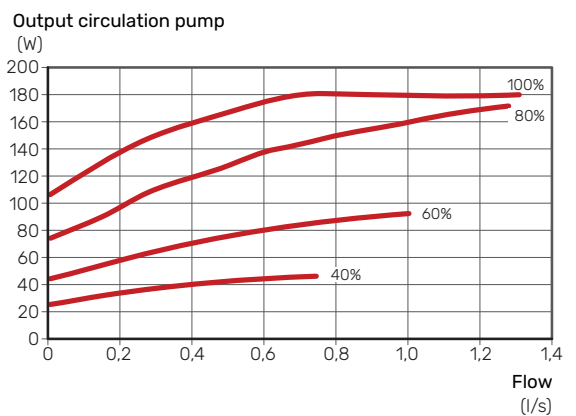
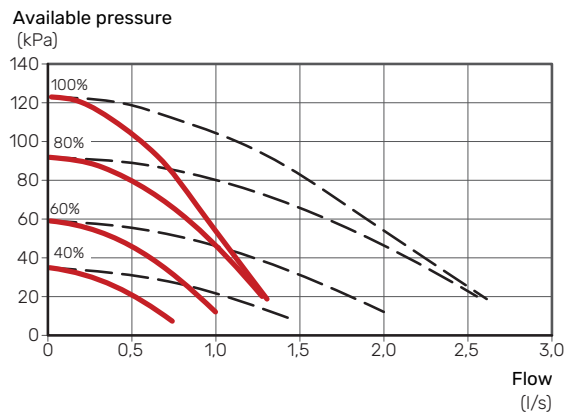

Climate system

To set the correct flow in the climate system, the heating medium pump must run at the correct speed. F1345 has a heating medium pump that can be automatically controlled in standard mode.

- 1 circulation pump
- - - 2 circulation pumps

F1345 24 kW

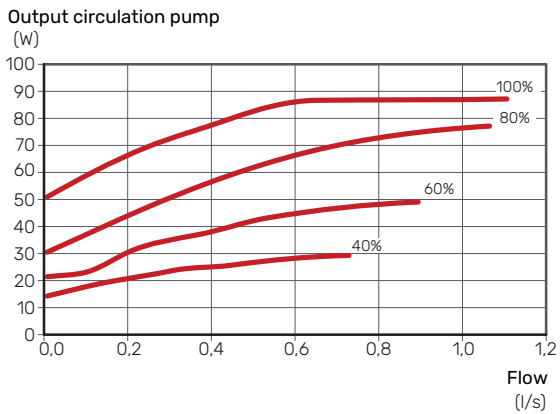
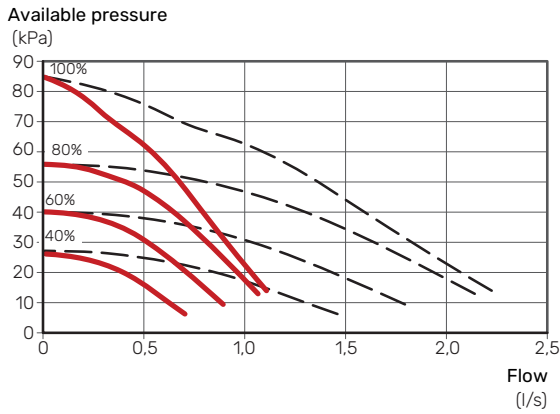

F1345 30 kW

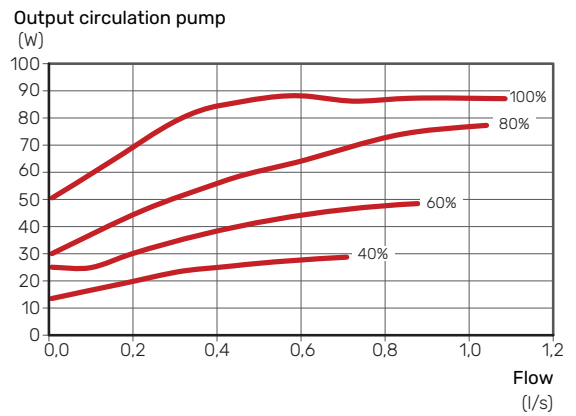
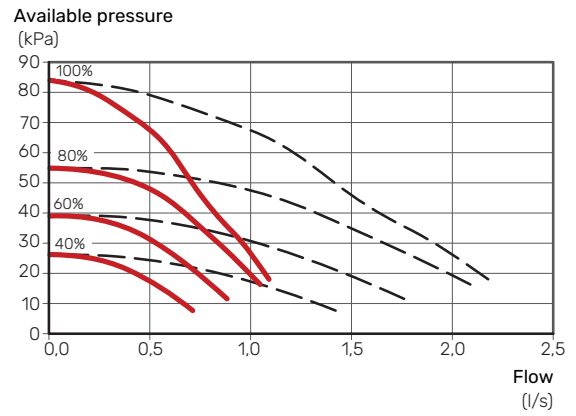

F1345 40 kW

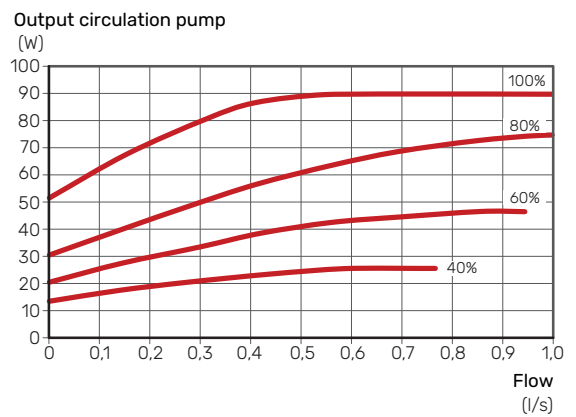
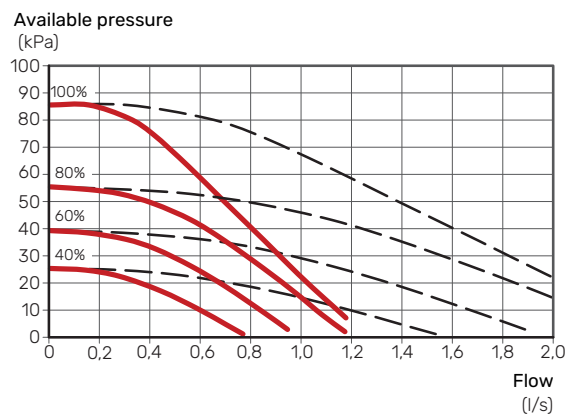

F1345 60 kW

Available pressure
(kPa)

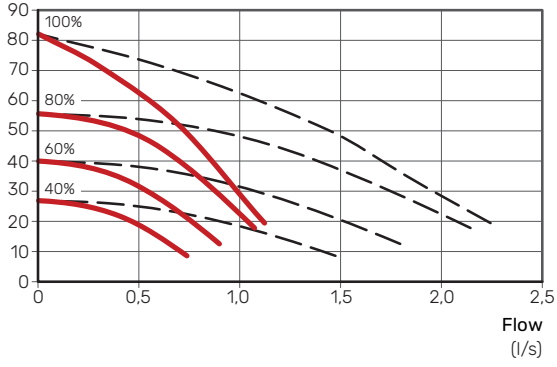

Output circulation pump
(W)

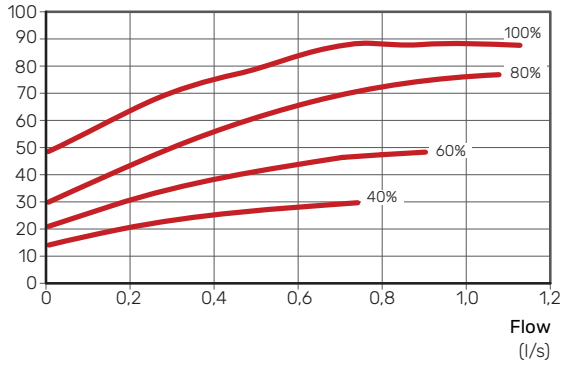

Accessories

Not all accessories are available on all markets.

Detailed information about the accessories and complete accessories list available at nibe.eu.

ACTIVE/PASSIVE COOLING IN 4-PIPE SYSTEM ACS 45

ACS 45 is an accessory that makes it possible for your heat pump to control the production of heating and cooling independently of each other.



ACTIVE/PASSIVE COOLING IN 2-PIPE SYSTEM HPAC 45

Combine F1345 with HPAC 45 for passive or active cooling.

Intended for heat pumps with outputs 24 – 60 kW.



EXTERNAL ELECTRIC ADDITIONAL HEAT ELK

These accessories may need an accessory board AXC 50 (step controlled additional heat).

ELK 15

15 kW, 3 x 400 V

ELK 26

26 kW, 3 x 400 V

ELK 42

42 kW, 3 x 400 V

ELK 213

7–13 kW, 3 x 400 V

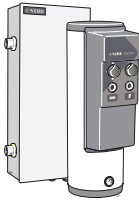

EXTRA SHUNT GROUP ECS

This accessory is used when F1345 is installed in houses with two or more different heating systems that require different supply temperatures.

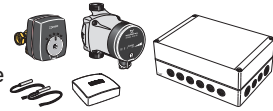

AUXILIARY RELAY HR 10

Auxiliary relay HR 10 is used to control external 1 to 3 phase loads such as oil burners, immersion heaters and pumps.



COMMUNICATIONS MODULE MODBUS 40

MODBUS 40 enables F1345 to be controlled and monitored using a DUC (computer sub-centre) in the building.

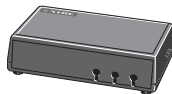

ASSEMBLY SYSTEM FMS

In systems where both the compressors are working to the same demand, 2 x packs of FMS 40 are required.

In systems where the lower compressor is used for hot water production or pool, 1 x pack of FMS 40 and 1 x pack of FMS 42 are required.

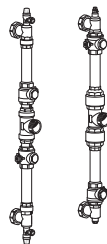

FILLING VALVE KIT KB

Valve kit for filling brine in the collector hose. Includes particle filter and insulation.

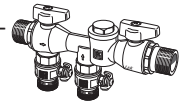

CURRENT SENSOR CMS 10-200

Current sensor with working area 0-200 A.



ACCESSORY CARD AXC 50

An accessory board is required if, for example, a ground water pump or external circulation pump is to be connected to F1345 at the same time as the indication of common alarm is activated.



BUFFER VESSEL UKV

A buffer vessel is an accumulator tank that is suitable for connection to a heat pump or another external heat source, and can have several different applications.



WATER HEATER/ACCUMULATOR TANK

For information regarding suitable water heaters, see nibe.eu.

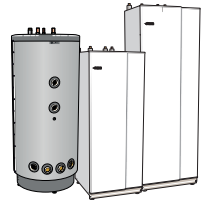

HOT WATER CONTROL

VST 11

Reversing valve, copper pipe Ø28
(Max recommended power, 17 kW)

VST 20

Reversing valve, copper pipe Ø35
(Max recommended power, 40 kW)

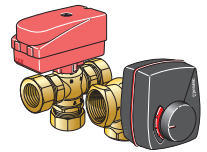



Sustainable energy solutions since 1952

NIBE has been manufacturing energy-efficient and sustainable climate solutions for your home for 70 years. It all began in Markaryd, in the southern Swedish province of Småland, and we recognise our Nordic heritage by utilising the power of nature. We combine renewable energy with smart technology to offer efficient solutions, allowing us to work together to create a more sustainable future.

Regardless of whether it is a chilly winter's day or a warm afternoon in the summer sun, we need a balanced indoor climate that allows us to enjoy a comfortable life, whatever the weather. Our extensive range of products supply your home with cooling, heating, ventilation and hot water, making it possible for you to create a pleasant indoor climate with little impact on the environment.

NIBE Energy Systems
Box 14, SE-285 21 Markaryd
nibe.eu



This product sheet is a publication from NIBE Energy Systems. All product illustrations, facts and data are based on current information at the time of the publication's approval. NIBE Energy Systems makes reservations for any factual or printing errors in this product sheet.