

Exhaust air heat pump

NIBE S735

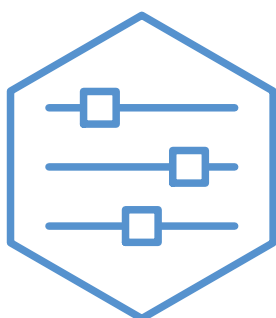

Quick guide

NAVIGATION

Select



Most options and functions are activated by lightly pressing on the display with your finger.

Scroll



If the menu has several sub-menus, you can see more information by dragging up or down with your finger.

Browse

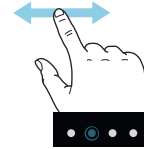

The dots at the bottom edge show that there are more pages.

Drag to the right or left with your finger to browse between the pages.

Smartguide

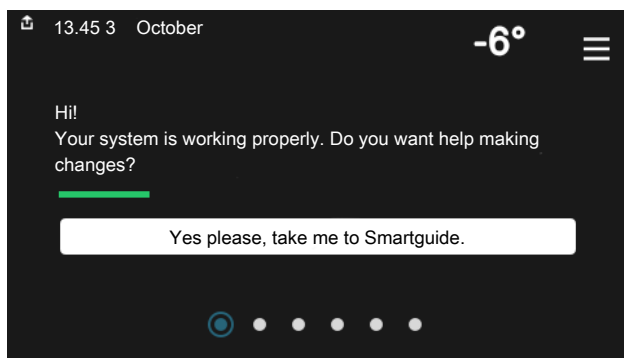

Smartguide helps you both to view information about the current status and to make the most common settings easily. The information that you see depends on the product you have and the accessories that are connected to the product.

Setting the indoor temperature.

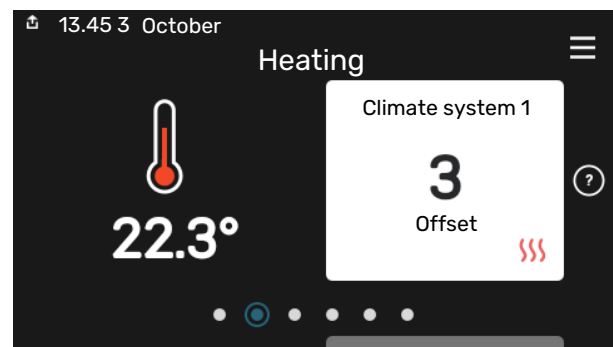

Here, you can set the temperature in the installation's zones.

Increasing hot water temperature

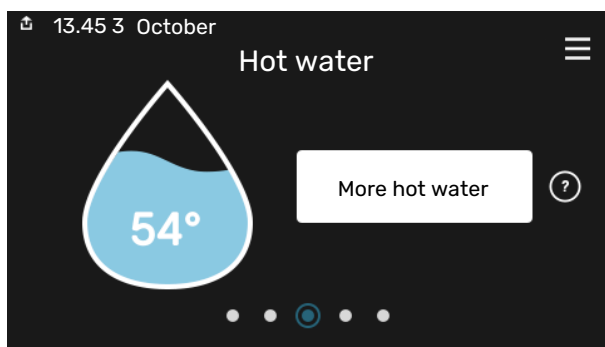

Here, you can start or stop a temporary increase in the hot water temperature.

Product overview

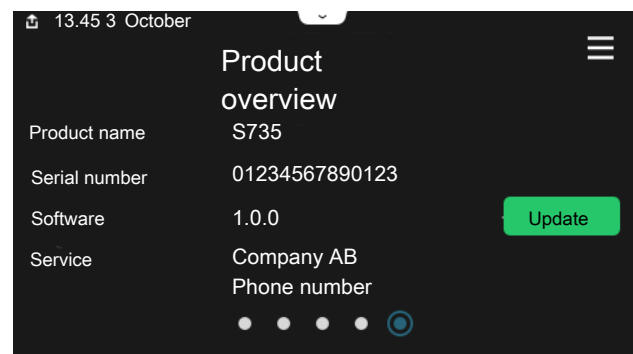

Here, you can find information about product name, the product's serial number, the version of the software and service. When there is new software to download, you can do it here (provided that S735 is connected to myUplink).

IN THE EVENT OF DISTURBANCES IN COMFORT

If you experience a disturbance in comfort of any kind, there are various measures you can take yourself before contacting your installer. For instructions, see section "Troubleshooting".

Table of Contents

1	Important information	4
	Installation data	4
	Symbols	5
	Serial number	5
2	Heat pump function	6
3	Control - Introduction	7
	Display unit	7
	Navigation	8
	Menu types	8
	Menu system	10
4	myUplink	11
	Specification	11
	Connection	11
	Range of services	11
5	Maintenance of S735	12
	Regular checks	12
	Saving tips	14
6	Disturbances in comfort	15
	Info-menu	15
	Manage alarm	15
	Troubleshooting	15
	Item register	17
	Contact information	19

Important information

Installation data

Product	S735
Serial number	
Installation date	
Installer	

No.	Name	Fact. sett.	Set
1.30.1	Curve, heating (heating curve and curve offset)		
1.30.4	Lowest supply heating	20	
7.1.4.1	Fan speed, exhaust air (Normal)	75%	
7.1.5.1	Max. set electrical power	Max	

✓	Accessories
	Extra shunt group ECS 40/41
	Supply air module SAM
	Extra water heater AHPS S/AHPH S
	Extra water heater VPB S
	Room unit RMU S40
	Solar panels NIBE PV

Serial number must always be given.

Certification that the installation is carried out according to instructions in the accompanying installer manual and applicable regulations.

Date _____

Signed _____

Symbols

Explanation of symbols that may be present in this manual.



NOTE

This symbol indicates danger to person or machine.



Caution

This symbol indicates important information about what you should observe when maintaining your installation.



TIP

This symbol indicates tips on how to facilitate using the product.

Serial number

The serial number can be found at the bottom right on S735, in the display on the home screen "Product overview" and on the type plate.

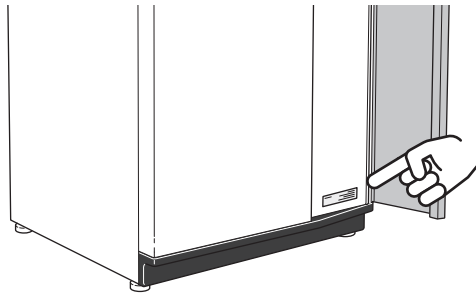

Caution

You need the product's (14 digit) serial number for servicing and support.

Heat pump function

An exhaust air heat pump utilises the heat in the house's ventilation air to heat up the dwelling. The ventilation air's energy is converted to residential heating in three different circuits. From the outgoing ventilation air (1), heating energy is recovered from the dwelling and transferred to the heat pump. The heat pump increases the recovered heat's low temperature to a high temperature in the refrigerant circuit (2). The heat is distributed around the house in the heating medium circuit (3).

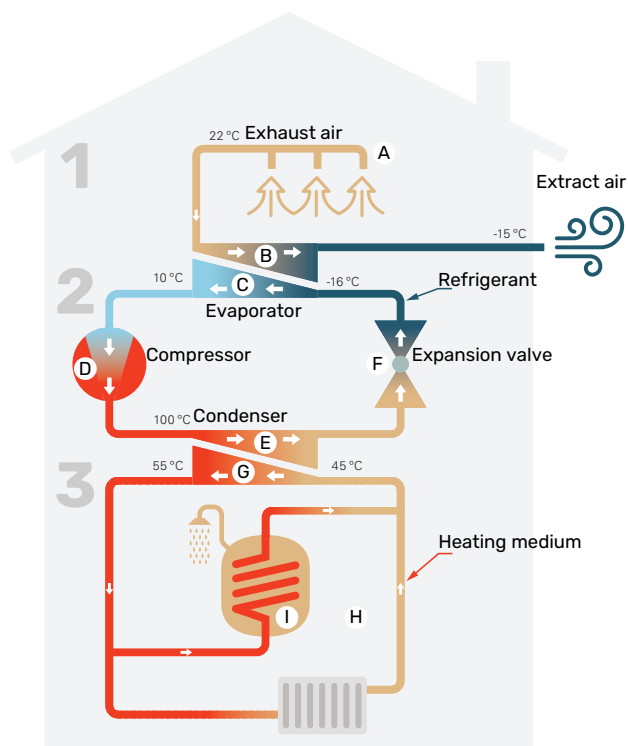

The temperatures are only examples and may vary between different installations and time of year.

Ventilation air

- A The hot air is transferred from the rooms to the heat pump via the house ventilation system.
- B The fan then routes the air to the heat pump's evaporator. Here, the air releases the heating energy and the air's temperature drops significantly. The cold air is then blown out of the house.

Refrigerant circuit

- C A liquid, a refrigerant, circulates in a closed system in the heat pump which also passes the evaporator. The refrigerant has a very low boiling point. In the evaporator the refrigerant receives the heat energy from the ventilation air and starts to boil.
- D The gas that is produced during boiling is routed into an electrically powered compressor. When the gas is compressed, the pressure increases and the gas's temperature increases considerably, from approx. -5°C to approx. 100°C .
- E From the compressor, the gas is forced into a heat exchanger, condenser, where it releases heat energy to the heat pump's heating section, whereupon the gas is cooled and condenses to liquid form again.
- F As the pressure is still high, the refrigerant can pass an expansion valve, where the pressure drops so that the refrigerant returns to its original temperature. The refrigerant has now completed a full cycle. It is routed to the evaporator again and the process is repeated.

Heat medium circuit

- G The heat energy that the refrigerant produces in the condenser is retrieved by the climate system's water, heating medium, which is heated to 55°C (supply temperature).
- H The heating medium circulates in a closed system and transports the heated water's heat energy to the heat pump's integrated hot water heater and the radiators/heating coils of the house.
- I The heat pump's integrated water heater is in the heating section. The heating medium heats the hot water.

Control - Introduction

Display unit

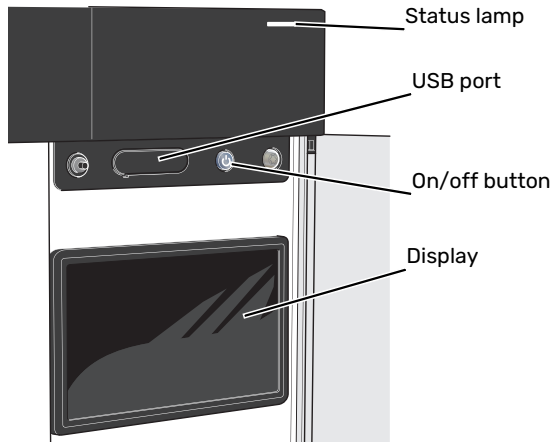

THE STATUS LAMP

The status lamp shows how well your system is operating. It:

- lights up white during normal operation.
- lights yellow in emergency mode.
- lights red in the event of a deployed alarm.
- flashes white during active notice.
- is blue when S735 is switched off.

If the status lamp is red, you receive information and suggestions for suitable actions on the display.



TIP

You also receive this information via myUplink.

THE USB PORT

Above the display, there is a USB port that can be used e.g. for updating the software. Log into myuplink.com and click the "General" and then "Software" tab to download the latest version of the software for your installation.

THE ON/OFF BUTTON

The on/off button has three functions:

- start
- switch off
- activate emergency mode

To start: press the on/off button once.

To switch off, restart or activate emergency mode: press and hold the on/off button for 2 seconds. This brings up a menu with various options.

For hard switch off: press and hold the on/off button for 5 seconds.

To activate emergency mode when S735 is switched off: press and hold the on/off button for 5 seconds. (Deactivate the emergency mode by pressing once.)

THE DISPLAY

Instructions, settings and operational information are shown on the display.

Navigation

S735 has a touchscreen where you simply navigate by pressing and dragging with your finger.

SELECT

Most options and functions are activated by lightly pressing on the display with your finger.



BROWSE

The dots at the bottom edge show that there are more pages.

Drag to the right or left with your finger to browse between the pages.

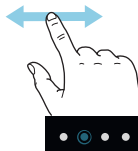

SCROLL

If the menu has several sub-menus, you can see more information by dragging up or down with your finger.

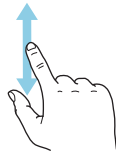

CHANGE A SETTING

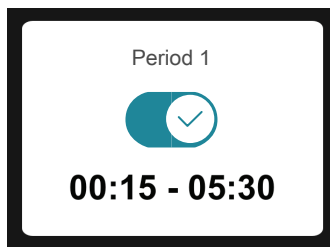

Press the setting you want to change.

If it is an on/off setting, it changes as soon as you press it.

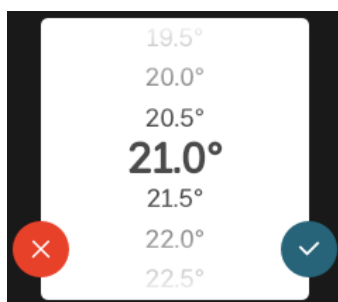

If there are several possible values, a spinning-wheel appears that you drag up or down to find the desired value.



Press  to save your change, or  if you don't want to make a change.

FACTORY SETTING

Factory set values are marked with *.

Your installer may have chosen other values that suit your system better.

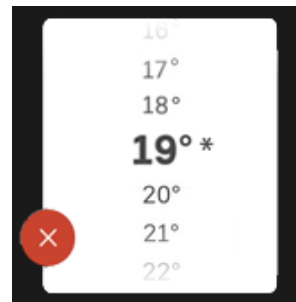

HELP MENU

 In many menus there is a symbol that indicates that extra help is available.

Press the symbol to open the help text.

You may need to drag with your finger to see all text.

Menu types

HOME SCREENS

Smartguide

Smartguide helps you both to view information about the current status and to make the most common settings easily. The information that you see depends on the product you have and the accessories that are connected to the product.

Select an option and press it to proceed. The instructions on the screen help you to choose correctly or give you information about what is happening.

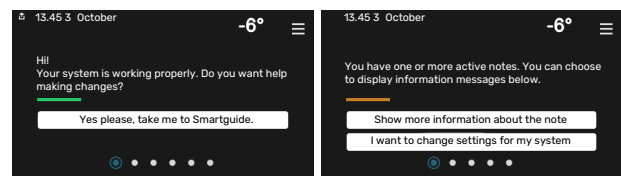

Function pages

On the function pages, you can both view information about the current status and easily make the most common settings. The function pages that you see depend on the product you have and the accessories that are connected to the product.

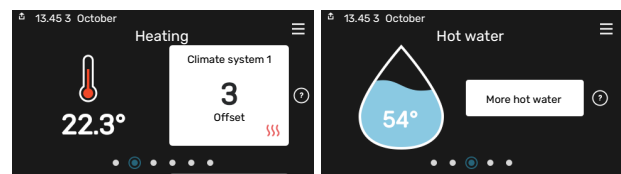

Drag to the right or left with your finger to browse between the function pages.

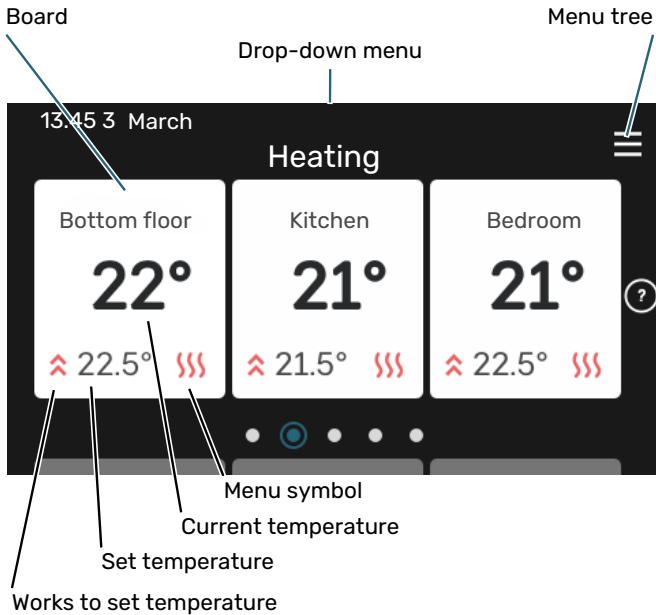

Press the card to adjust the desired value. On certain function pages, drag your finger up or down to obtain more cards.

Product overview

It can be a good idea to have the product overview open during any service cases. You can find it among the function pages.

Here, you can find information about product name, the product's serial number, the version of the software and service. When there is new software to download, you can do it here (provided that S735 is connected to myUplink).

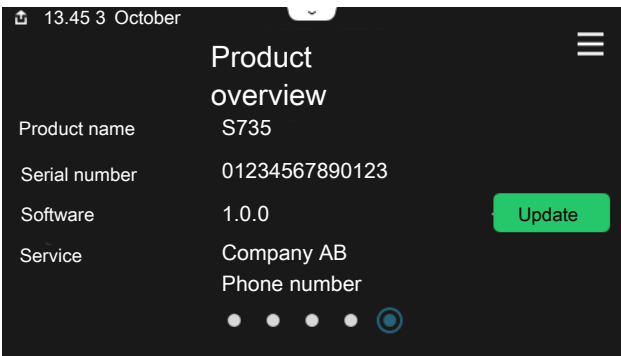

Drop-down menu

From the home screens, you reach a new window containing further information by dragging down a drop-down menu.

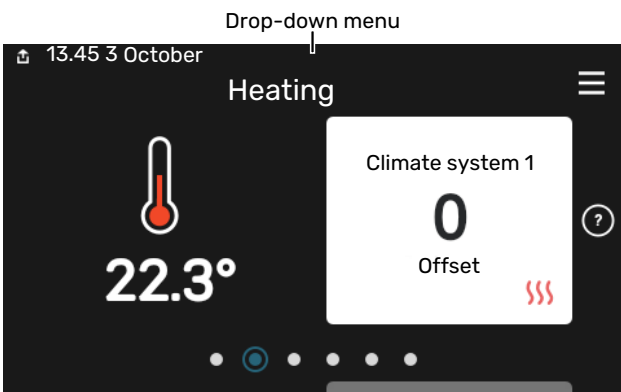

The drop-down menu shows the current status for S735, what is in operation and what S735 is doing at the moment. The functions that are in operation are highlighted with a frame.

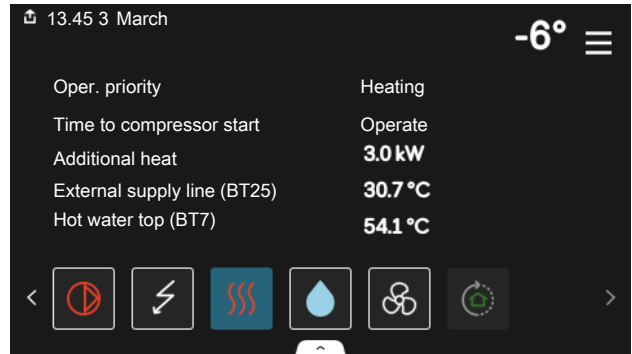

Press the icons on the menu's lower edge for more information about each function. Use the scroll bar to view all information for the selected function.

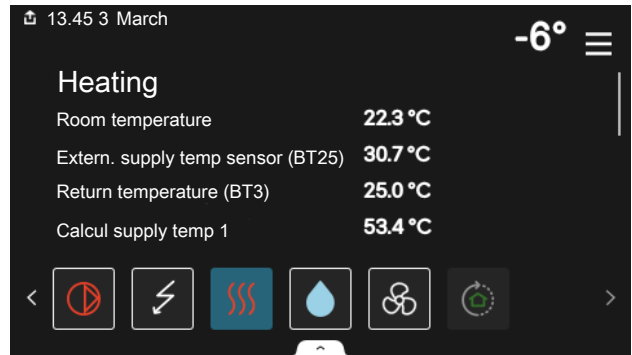

MENU TREE

In the menu tree, you can find all menus and can make more advanced settings.

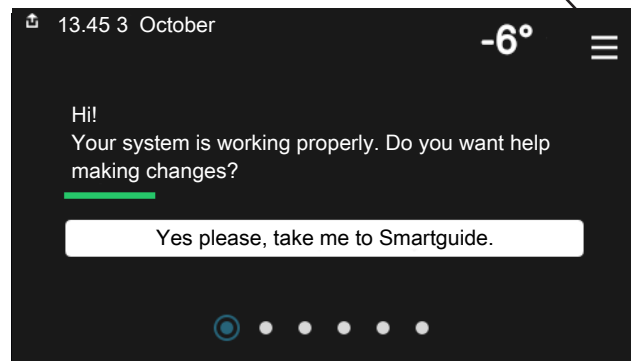

You can always press "X" to return to the home screens.

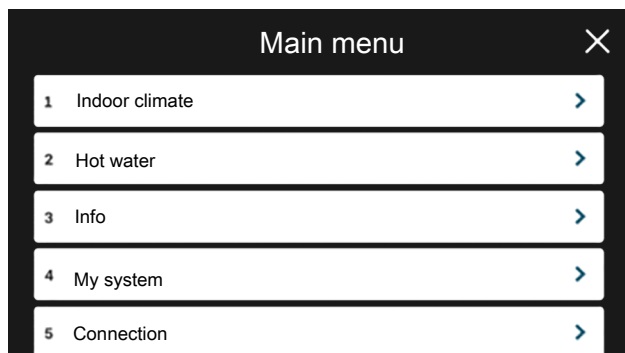

Menu system

MENU TREE

The menu tree consists of eight main menus. For a detailed description, see the Installer Manual.

Menu 1 - Indoor climate

Here, you make settings for indoor temperatures and ventilation (accessory is required).

Menu 2 - Hot water

You make settings for hot water operation here.

Menu 3 - Info

Here, you can read current operating information and you can find various logs with older information

Menu 4 - My system

Here, you set date, language, operating mode, etc.

Menu 5 - Connection

Here, you connect your system to myUplink, manage wireless accessories and make network settings.

Menu 6 - Scheduling

Here, you schedule different parts of the system.

Menu 7 - Installer settings

Advanced settings are made here. This menu is only intended for installers or service engineers.

Menu 8 - USB

This menu lights up when a USB memory is connected. You can update the software here, for example.

myUplink

With myUplink you can control the installation – where and when you want. In the event of any malfunction, you receive an alarm directly to your e-mail or a push notification to the myUplink app, which allows you to take prompt action.

Visit myuplink.com for more information.



Caution

Before you can start using myUplink, the product has to be installed and set up according to the instructions in the Installer Manual.

Specification

You need the following in order for myUplink to be able to communicate with your S735:

- wireless network or network cable
- Internet connection
- account on myuplink.com

We recommend our mobile apps for myUplink.

Connection

To connect your system to myUplink:

1. Select connection type (wifi/Ethernet) in menu 5.2.1 or 5.2.2.
2. In menu 5.1 you select "Request new connection string".
3. When a connection string has been produced, it is shown in this menu and is valid for 60 minutes.
4. If you do not already have an account, register in the mobile app or on myuplink.com.
5. Use the connection string to connect your installation to your user account on myUplink.

Range of services

myUplink gives you access to various levels of service. The base level is included and, apart from this, you can choose two premium services for a fixed annual fee (the fee varies depending on the functions selected).

Service level	Basic	Premium extended history	Premium change settings
Viewer	X	X	X
Alarm	X	X	X
History	X	X	X
Extended history	-	X	-
Manage	-	-	X

Maintenance of S735

Regular checks

Your heat pump requires minimal maintenance after commissioning. On the other hand, it is recommended that you check your installation regularly.

If something unusual occurs, messages about the malfunction appear in the display in the form of different alarm texts. See alarm management on page 15.



Caution

The fan is in operation, even when S735 is turned off and the status lamp is lit with a blue light.

SERVICE HATCH

The vent valves etc. are behind the service hatch. Remove the hatch by pulling it towards you.

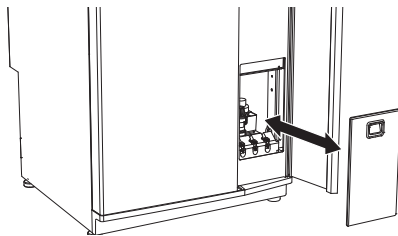

CLEANING THE VENTILATION DEVICES

The building's ventilation devices should be cleaned regularly with, for example, a small brush to maintain the correct ventilation.

The device settings must not be changed.

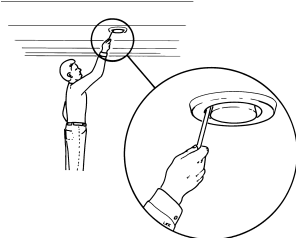

NOTE

If you take down more than one ventilation device for cleaning, do not mix them up.

REPLACING EXHAUST AIR FILTER

The filter in S735 is of a type that should not be cleaned, but has to be replaced instead. Replacement must be performed regularly, at least once a year. More frequent intervals may be necessary, depending on the quantity of particles in the air as well as other environmental factors. Test to find out what is most appropriate for your installation.



Caution

The efficiency of the installation can be impaired by a dirty air filter.

In the display, you will receive a reminder to check the filter. The factory setting for the reminder is every three months.

1. Turn off S735 using the on/off button .
2. Remove the upper front cover by pulling straight out.
3. Open the filter cover.
4. Pull out the filter.
5. Check the condition of the filter and replace if needed.
6. Carry out assembly in reverse order.

Even if the filter looks clean, dirt collects in it and this affects the efficiency of the filter. For this reason, the filter must be replaced at least once a year. A new filter can be ordered via a dealer for NIBE or from the website nibe.eu.

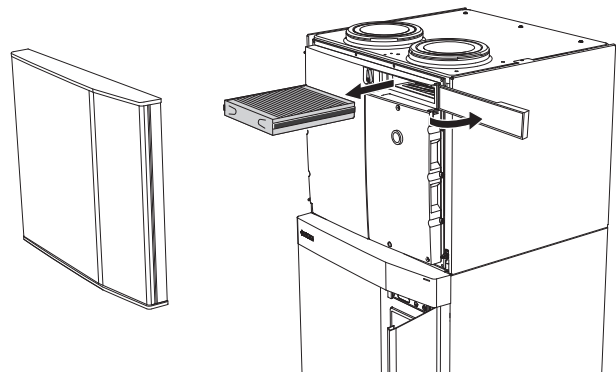

CHECK PRESSURE

S735 has a pressure gauge which shows the heating system pressure. The pressure should be between 0.5 and 1.5 bar, but varies during temperature changes. If the pressure drops to 0 or rises to 2.5 frequently, contact your installer for troubleshooting.

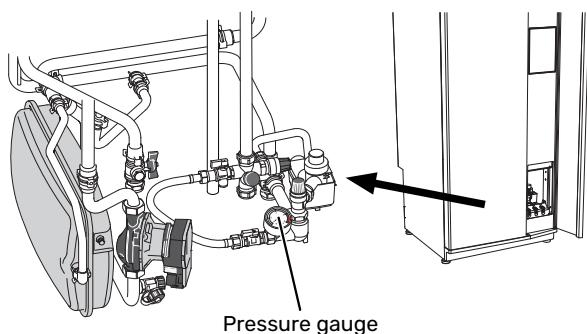

SAFETY VALVES

S735 has two safety valves, one for the hot water and one for the climate system.

The safety valve for the hot water sometimes releases a little water after hot water usage. This is because the cold water that enters S735 expands when heated, causing the pressure to rise and the safety valve to open. The climate system's safety valve should be completely closed and normally does not release any water.

The function of the safety valves must be checked regularly. The valves are accessed via the service hatch. Perform checks as follows:

1. Open the valve by turning the knob anti-clockwise carefully.
2. Check that water flows through the valve.
3. Close the valve by releasing it. If it does not close automatically when released, turn it anti-clockwise slightly.
4. The climate system may need to be refilled after checking the safety valve, see section "Filling the climate system".

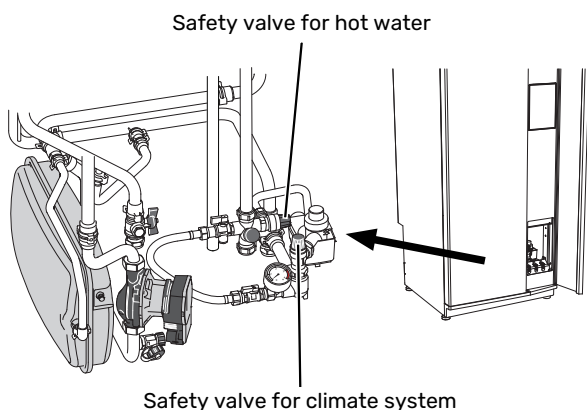

FILLING THE CLIMATE SYSTEM

If the pressure is too low, increase as follows:

1. Open the filling valves. The heating unit and the rest of the climate system fill with water.

2. After a while the pressure rises on the pressure gauge. When it is approx. 1.0 bar close the filler valves.

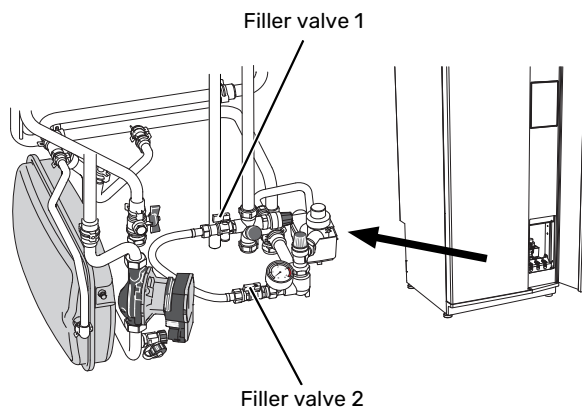

VENTING THE CLIMATE SYSTEM



TIP

Use the enclosed venting hose for simpler and easier venting.

In event of repeated filling of the climate system or if bubbling sounds are heard from the heat pump the system may need venting. This is carried out as follows:

1. Turn off S735 using the on/off button .
2. Vent the heat pump via the vent valves and the rest of the climate system via its respective vent valves.
3. Keep topping up and venting until all air has been removed and the pressure is correct.



NOTE

The vent hoses from the container must be drained of water before air can be released. This means that the system is not necessarily vented despite the flow of water when the vent valves are opened.

Therefore hold the vent valves open at least 5 seconds.

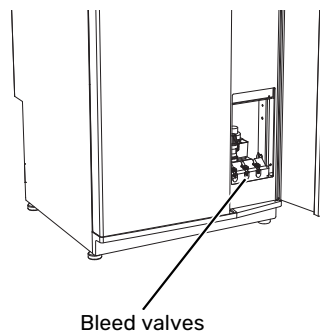

CLEANING THE FLOOR DRAIN

Condensation forms when the heat pump is working. This condensation is routed via an overflow cup to a drain, e.g. a floor drain.

The condensation water contains a certain amount of dust and particles.

Check regularly that any floor drains are not blocked; water must be able to run through freely. Clean, if necessary.

Saving tips

Your heat pump installation produces heat and hot water. This occurs via the control settings you made.

Factors that affect the energy consumption are, for example, indoor temperature, hot water consumption, the insulation level of the house and whether the house has many large window surfaces. The position of the house, e.g. wind exposure is also an affecting factor.

Even the house ventilation affects the energy consumption. It is therefore important to perform a ventilation adjustment shortly after installing the heat pump. At ventilation adjustment, a ventilation technician sets the house ventilation device and the fan in S735 according to the projected values of the house.

Also remember:

- Open the thermostat valves completely (except in rooms where you want it to be cooler). This is important, as fully or partially closed thermostat valves slow the flow in the climate system, which results in S735 working at a higher temperature. This in turn can lead to increased energy consumption.
- During the adjustment period (winter time), all thermostat valves should be fully open. The heat pump's heating settings are then adjusted so that the correct indoor temperature is obtained, in most rooms, regardless of the outdoor temperature. In rooms where a lower temperature is required, the thermostat valves are lowered to the desired level. After about a month, the remaining thermostats can be lowered slightly to avoid an increase of the room temperature due to solar radiation, stove heat, etc. Further reductions may be required later on.
- You can lower the operating cost when away from home by scheduling selected parts of the system. This is done in menu 6 - "Scheduling".
- If you select "Small" in menu 2.2 - "Hot water demand", less energy is used.

Disturbances in comfort

In most cases, S735 notes a malfunction (a malfunction can lead to disruption in comfort) and indicates this with alarms, and instructions for action, in the display.

Info-menu

All the heat pump's measurement values are gathered under menu 3.1 - "Operating info" in the heat pump's menu system. Examining the values in this menu can often make it easier to identify the source of the fault.

Manage alarm

In the event of an alarm, a malfunction has occurred and the status lamp shines with a steady red light. You receive information about the alarm in the smartguide on the display.

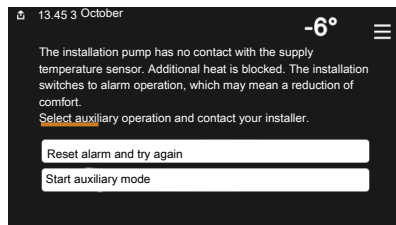
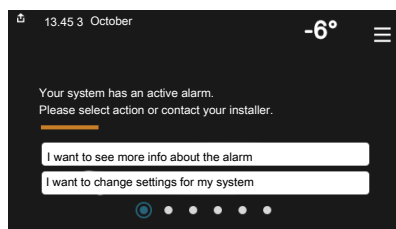

ALARM

In the event of an alarm with a red status lamp, a malfunction has occurred that S735 cannot remedy itself. On the display, you can see what type of alarm it is and reset it.

In many cases, it is sufficient to select "Reset alarm and try again" for the installation to revert to normal operation.

If a white light comes on after selecting "Reset alarm and try again", the alarm has been remedied.

"Auxiliary operation" is a type of emergency mode. This means that the installation tries to produce heat and/or hot water, even though there is some kind of problem. This could mean that the compressor is not in operation. In this case, any electric additional heating produces heat and/or hot water.



Caution

Selecting "Auxiliary operation" is not the same as correcting the problem that caused the alarm. The status lamp will therefore remain red.

If the alarm does not reset, contact your installer for suitable remedial action.



Caution

You need the product's (14 digit) serial number for servicing and support.

Troubleshooting

If the operational interference is not shown in the display the following tips can be used:

BASIC ACTIONS

Start by checking the following items:

- Group and main fuses of the accommodation.
- The property's earth circuit breaker.
- Heat pump's earth-fault breaker.

LOW HOT WATER TEMPERATURE OR A LACK OF HOT WATER

- Closed or choked filling valve for the hot water.
 - Open the valve.
- Mixing valve (if there is one installed) set too low.
 - Adjust the mixer valve.
- S735 in incorrect operating mode.
 - Contact your installer!
- Large hot water consumption.
 - Wait until the hot water has heated up. Temporarily increased hot water capacity can be activated in the "Hot water" home screen, in menu 2.1 - "More hot water" or via myUplink.
- Too low hot water setting.
 - Enter menu 2.2 - "Hot water demand" and select a higher demand mode.
- Too low or no operating prioritisation of hot water.
 - Contact your installer!
- "Holiday" activated in menu 6.
 - Enter menu 6 and deactivate.
- The exhaust air filter is clogged.
 - Change the filter.

LOW ROOM TEMPERATURE

- Closed thermostats in several rooms.
 - Set the thermostats to max in as many rooms as possible. Adjust the room temperature via the "Heating" home screen, rather than turning down the thermostats.
- S735 in incorrect operating mode.
 - Contact your installer!
- Too low set value on the automatic heating control.
 - Go to the Smartguide for help in increasing heating. You can also change the heating in the "Heating" home screen.
- Too low or no operating prioritisation of heat.
 - Contact your installer!

- Hot water demand "Large" selected in combination with large hot water outlet.
 - When you have selected hot water demand "Large", S735 prioritises hot water production over heat production.
 - If you want to change hot water mode: Enter menu 2.2 and select "Small" or "Medium".
- "Holiday" activated in menu 6 - "Scheduling".
 - Enter menu 6 and deactivate.
- External switch for changing room temperature activated.
 - Check any external switches.
- Air in the climate system.
 - Vent the climate system.
- Closed valves to the climate system.
 - Open the valves (contact your installer for assistance in finding them).
- The exhaust air filter is clogged.
 - Change the filter.

HIGH ROOM TEMPERATURE

- Too high set value on the automatic heating control.
 - Go to the Smartguide for help in lowering the heating. You can also change the heating from the "Heating" home screen.
- External switch for changing room temperature activated.
 - Check any external switches.

LOW SYSTEM PRESSURE

- Not enough water in the climate system.
 - Fill the climate system with water and check for leaks. In event of repeated filling, contact the installer.

LOW OR A LACK OF VENTILATION

- The exhaust air filter is clogged.
 - Change the filter.
- The ventilation is not adjusted.
 - Order ventilation adjustment.
- Exhaust air device blocked or throttled down too much.
 - Check and clean the exhaust air devices (see page 12).
- Fan speed in reduced mode.
 - Enter menu 1.2.1 - "Fan speed" and select "Normal"
- Scheduling activated.
 - Enter menu 6 - "Scheduling". Switch off the function or adjust the settings.
- External switch for changing the fan speed activated.
 - Check any external switches.

HIGH OR DISTRACTING VENTILATION

- The exhaust air filter is clogged.

- Change the filter.
- The ventilation is not adjusted.
 - Order ventilation adjustment.
- Fan speed in forced mode.
 - Enter menu 1.2.1 - "Fan speed" and select "Normal"
- Night cooling activated.
 - Enter menu 1.2.2 - "Night cooling". Switch off the function or adjust the settings.
- Scheduling activated.
 - Enter menu 6 - "Scheduling". Switch off the function or adjust the settings.
- External switch for changing the fan speed activated.
 - Check any external switches.

THE COMPRESSOR DOES NOT START

- There is no heating or hot water demand.
 - S735 does not call on heating or hot water.
- The heat pump defrosts.
 - The compressor starts, when defrosting is complete.
- Compressor blocked due to the temperature conditions.
 - Wait until the temperature is within the product's working range.
- Minimum time between compressor starts has not been reached.
 - Wait for at least 30 minutes and then check if the compressor has started.
- Alarm tripped.
 - Follow the display instructions.

Item register

A

Alarm, 15

C

Control, 7

Control - Introduction, 7

Control - Introduction, 7

D

Disruption to comfort

Info menu, 15

Disturbances in comfort, 15

Alarm, 15

Manage alarm, 15

Troubleshooting, 15

H

Heat pump function, 6

Help menu, 8

I

Important information

Installation data, 4

Serial number, 5

Info menu, 15

Installation data, 4

M

Maintenance of S735, 12

Regular checks, 12

Saving tips, 14

Manage alarm, 15

N

Navigation

Help menu, 8

R

Regular checks, 12

Replacing exhaust air filter, 12

Exhaust air filter, 12

S

Saving tips, 14

Serial number, 5

T

Troubleshooting, 15

Contact information

AUSTRIA

KNV Energietechnik GmbH
Gahberggasse 11, 4861 Schörfling
Tel: +43 (0)7662 8963-0
mail@knv.at
knv.at

FINLAND

NIBE Energy Systems Oy
Juurakkotie 3, 01510 Vantaa
Tel: +358 (0)9 274 6970
info@nibe.fi
nibe.fi

GREAT BRITAIN

NIBE Energy Systems Ltd
3C Broom Business Park,
Bridge Way, S41 9QG Chesterfield
Tel: +44 (0)330 311 2201
info@nibe.co.uk
nibe.co.uk

POLAND

NIBE-BIAWAR Sp. z o.o.
Al. Jana Pawla II 57, 15-703 Białystok
Tel: +48 (0)85 66 28 490
biawar.com.pl

CZECH REPUBLIC

Družstevní závody Dražice - strojírna
s.r.o.
Dražice 69, 29471 Benátky n. Jiz.
Tel: +420 326 373 801
nibe@nibe.cz
nibe.cz

FRANCE

NIBE Energy Systems France SAS
Zone industrielle RD 28
Rue du Pou du Ciel, 01600 Reyrieux
Tél: 04 74 00 92 92
info@nibe.fr
nibe.fr

NETHERLANDS

NIBE Energietechnik B.V.
Energieweg 31, 4906 CG Oosterhout
Tel: +31 (0)168 47 77 22
info@nibenl.nl
nibenl.nl

SWEDEN

NIBE Energy Systems
Box 14
Hannabadsvägen 5, 285 21 Markaryd
Tel: +46 (0)433-27 30 00
info@nibe.se
nibe.se

DENMARK

Vølund Varmeteknik A/S
Industrivej Nord 7B, 7400 Herning
Tel: +45 97 17 20 33
info@volundvt.dk
volundvt.dk

GERMANY

NIBE Systemtechnik GmbH
Am Reiherpfahl 3, 29223 Celle
Tel: +49 (0)5141 75 46 -0
info@nibe.de
nibe.de

NORWAY

ABK-Qviller AS
Brobekkeveien 80, 0582 Oslo
Tel: (+47) 23 17 05 20
post@abkqviller.no
nibe.no

SWITZERLAND

NIBE Wärmetechnik c/o ait Schweiz AG
Industriepark, CH-6246 Altishofen
Tel. +41 (0)58 252 21 00
info@nibe.ch
nibe.ch

For countries not mentioned in this list, contact NIBE Sweden or check nibe.eu for more information.

NIBE Energy Systems
Hannabadsvägen 5
Box 14
285 21 Markaryd
info@nibe.se
nibe.eu

UHB EN 2326-2 M12603

This is a publication from NIBE Energy Systems. All product illustrations, facts and data are based on the available information at the time of the publication's approval.

NIBE Energy Systems makes reservations for any factual or printing errors in this publication.

©2023 NIBE ENERGY SYSTEMS

