

Installer manual



Indoor module

NIBE VVM S320 UK 1 X 230 V



IHB EN 2327-1
631815

Quick guide

NAVIGATION

Select



Most options and functions are activated by lightly pressing on the display with your finger.

Scroll



If the menu has several sub-menus, you can see more information by dragging up or down with your finger.

Browse

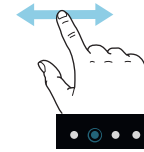

The dots at the bottom edge show that there are more pages.

Drag to the right or left with your finger to browse between the pages.

Smartguide

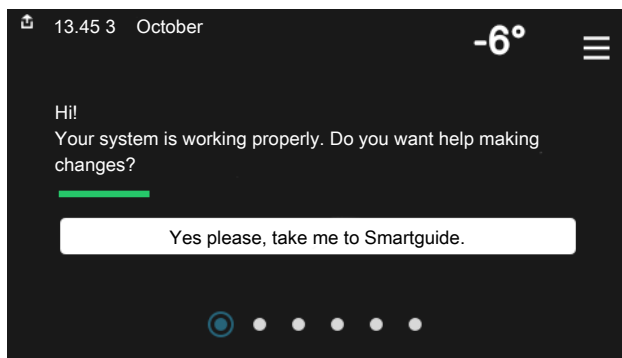

Smartguide helps you both to view information about the current status and to make the most common settings easily. The information that you see depends on the product you have and the accessories that are connected to the product.

Setting the indoor temperature.

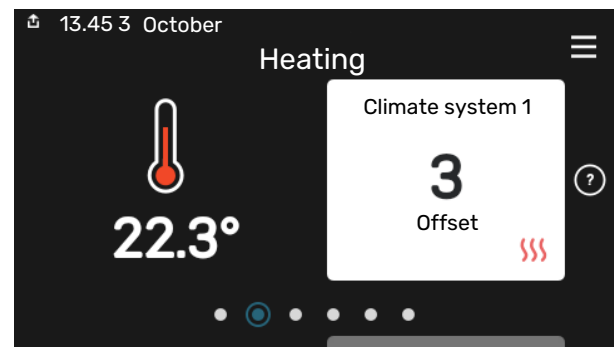

Here, you can set the temperature in the installation's zones.

Increasing hot water temperature

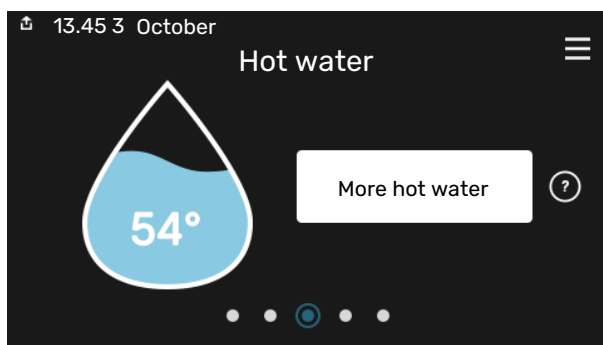

Here, you can start or stop a temporary increase in the hot water temperature.

Product overview

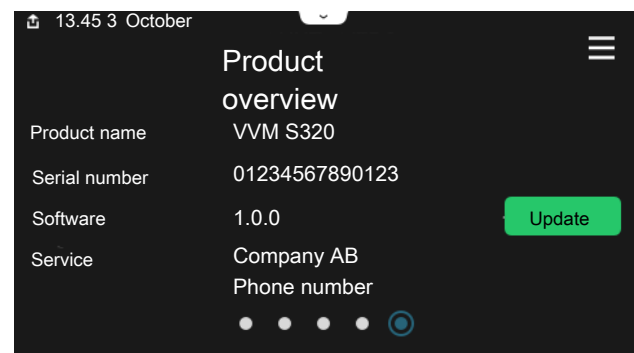

Here, you can find information about product name, the product's serial number, the version of the software and service. When there is new software to download, you can do it here (provided that VVM S320 is connected to myUplink).

Table of Contents

1	Important information	4	8	Control - Introduction	36
	Safety information	4		Display unit	36
	Symbols	4		Navigation	37
	Marking	4		Menu types	37
	Serial number	4		Climate systems and zones	39
	Country specific information	5	9	Control - Menus	40
	Inspection of the installation	6		Menu 1 - Indoor climate	40
	Compatible outdoor modules	7		Menu 2 - Hot water	44
2	Delivery and handling	8		Menu 3 - Info	46
	Transport	8		Menu 4 - My system	47
	Assembly	8		Menu 5 - Connection	51
	Supplied components	9		Menu 6 - Scheduling	52
	Handling panels	10		Menu 7 - Service	53
3	Indoor module's design	12	10	Service	60
	General	12		Service actions	60
	Distribution boxes	14	11	Disturbances in comfort	63
4	Pipe connections	15		Info-menu	63
	General	15		Manage alarm	63
	Dimensions and pipe connections	19		Troubleshooting	63
	Connecting to air/water heat pump	19	12	Accessories	65
	Use without heat pump	20			
	Climate system	20	13	Technical data	67
	Cold and hot water	20		Dimensions	67
	Installation alternative	20		Technical specifications	68
5	Electrical connections	22		Electrical circuit diagram	70
	General	22			
	Connections	24		Item register	74
	Settings	29		Contact information	79
6	Commissioning and adjusting	30			
	Preparations	30			
	Filling and venting	30			
	Start-up and inspection	31			
	Setting the cooling/heating curve	32			
7	myUplink	35			
	Specification	35			
	Connection	35			
	Range of services	35			

Important information

Safety information

This manual describes installation and service procedures for implementation by specialists.

The manual must be left with the customer.

For the latest version of the product's documentation, see nibe.co.uk.



NOTE

Also read the enclosed Safety Manual before starting the installation.

Symbols

Explanation of symbols that may be present in this manual.



NOTE

This symbol indicates danger to person or machine.



Caution

This symbol indicates important information about what you should consider when installing or servicing the installation.



TIP

This symbol indicates tips on how to facilitate using the product.

Marking

Explanation of symbols that may be present on the product's label(s).



Dangerous voltage.



Danger to person or machine.



Read the User Manual.



Disconnect the voltage supply before starting work.

Serial number

The serial number can be found at the bottom right on VVM S320, in the display on the home screen "Product overview" and on the type plate (PZ1).

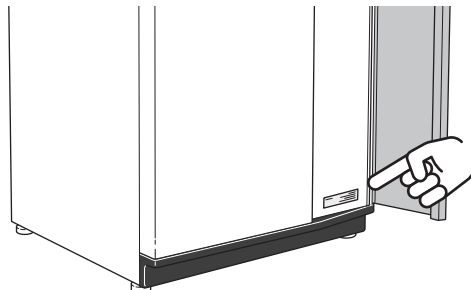

Caution

You need the product's (14 digit) serial number for servicing and support.

Country specific information

UNITED KINGDOM

This installation is subject to building regulation approval, notify the local Authority of intention to install.

Use only manufacturer's recommended replacement parts.

For more information see nibe.co.uk.



Benchmark places responsibilities on both manufacturers and installers. The purpose is to ensure that customers are provided with the correct equipment for their needs, that it is installed, commissioned and serviced in accordance with the manufacturers instructions by competent persons and that it meets the requirements of the appropriate Building Regulations. The Benchmark Checklist can be used to demonstrate compliance with Building Regulations and should be provided to the customer for future reference.

Installers are required to carry out the installation, commissioning and servicing work in accordance with the Benchmark Code of practice which is available from the Heating and Hotwater Industry Council who manage and promote the Scheme. Visit centralheating.co.uk for information.

Warranty and insurance information

Thank you for installing a new NIBE heat pump in your home.

NIBE heat pumps are manufactured in Sweden to the very highest standard so we are pleased to offer our customers a comprehensive guarantee.

The product is guaranteed for 24 months for parts and labour from the date of installation or 33 months from the date of manufacture, whichever is the shorter.

The NIBE guarantee is based on the unit being installed and commissioned by a NIBE accredited installer, serviced every year and the Benchmark documents completed. Where this condition is not met, any chargeable spare parts or components issued within the applicable guarantee period still benefit from a 12 month warranty from the date of issue by the manufacturer.

We recommend the installer completes and returns as soon as possible, your guarantee registration card or completes the guarantee form on the NIBE website, www.nibe.co.uk

Inspection of the installation

Current regulations require the heating installation to be inspected before it is commissioned. The inspection must be carried out by a suitably qualified person. Fill in the page for information about installation data in the User manual.

✓	Description	Notes	Signature	Date
	Connecting to air/water heat pump			
	System flushed			
	System vented			
	Particle filter			
	Safety valve			
	Shut off valves			
	System pressure			
	Connected according to outline diagram			
	Flows according to table in section "Minimum system flows", chapter "Pipe connections"			
	Cold and hot water			
	Shut off valves			
	Mixing valve			
	Safety valve			
	Pressure reduction valve			
	Tundish			
	Expansion vessel			
	Electrical connections			
	Connected communication			
	Circuit fuses			
	Fuses property			
	Outside sensor			
	Room sensor			
	Current sensor			
	Safety breaker			
	Earth circuit-breaker			
	Setting emergency mode			
	Miscellaneous			
	Warranty			
	Benchmark checklist			
	Docked to			

Compatible outdoor modules

F2040

F2040-12

Part no. 064 092

F2120

F2120-8 1x230 V

Part no. 064 134

F2120-12 1x230 V

Part no. 064 136

S2125

S2125-8 1x230 V

Part no. 064 220

S2125-12 1x230 V

Part no. 064 218

NIBE SPLIT HBS 05

AMS 10-12

Part no. 064 110

HBS 05-12

Part no. 067 480

NIBE SPLIT HBS 20

AMS 20-6

Part no. 064 235

HBS 20-6

Part no. 067 668

AMS 20-10

Part no. 064 319

HBS 20-10

Part no. 067 819

Delivery and handling

Transport

VVM S320 should be transported and stored vertically in a dry place.

However, the VVM S320 can be carefully laid on its back when being moved into the building.

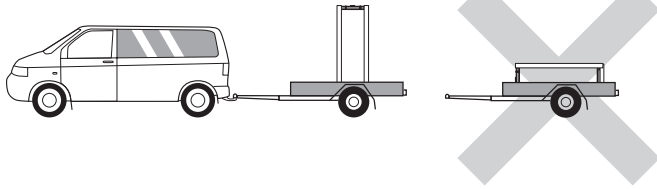

Assembly

- Position VVM S320 on a solid foundation indoors that withstands water and the weight of the product.
- Use the product's adjustable feet to attain a horizontal and stable set-up.

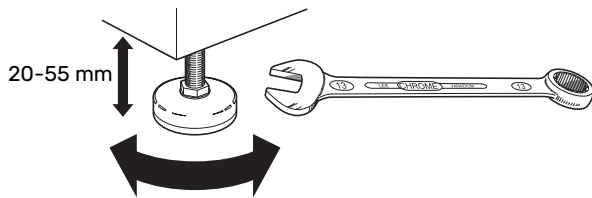

- The space where VVM S320 is located must be frost-free.
- Since water comes from VVM S320, the area where VVM S320 is located must be equipped with floor drainage.

INSTALLATION AREA

Leave a free space of 800 mm in front of the product. All service on VVM S320 can be carried out from the front.

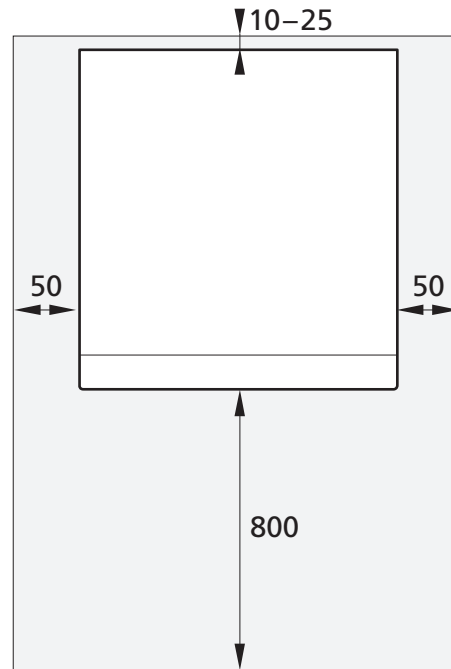

NOTE

Leave 10 - 25 mm free space between VVM S320 and the wall behind for routing cables and pipes.

Supplied components

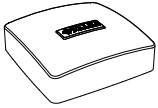

Outdoor temperature sensor (BT1)
1 x



Room sensor (BT50)
1 x

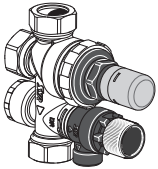

Valve connector (pressure reduction valve (QN17), expansion relief valve (FL1) and non-return valve (RM1))
1 x



2 x Tundish (WM3)
1 x

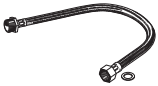

Armoured hose (expansion vessel)
1 x



Connector with cable
1 x



Expansion vessel domestic water (CM4) with holder (enclosed separately)
1 x

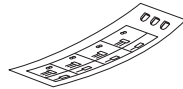

Label for external control voltage for the control system
1 x

LOCATION

The kit of enclosed items is placed on top of the indoor module.

Handling panels

OPEN FRONT HATCH

Press the hatch's top left corner to open it.



REMOVE THE FRONT

1. Remove the screw in the hole next to the on/off button (SF1).

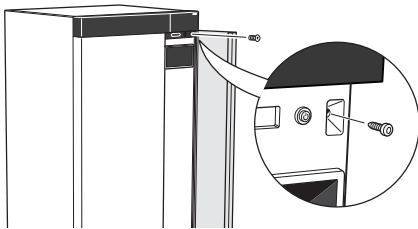

2. Pull the panel's top edge towards you and lift diagonally upwards to remove it from the frame.

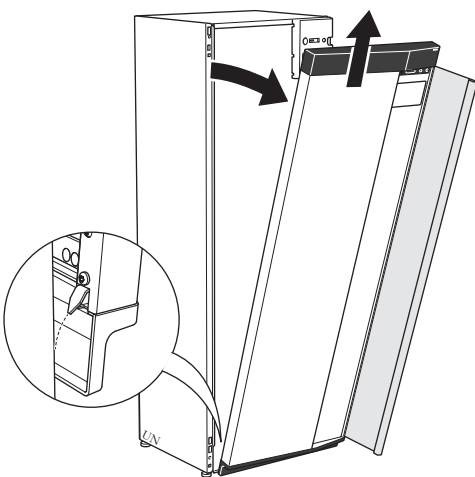

ASSEMBLE THE FRONT

1. Hook one bottom corner of the front onto the frame.

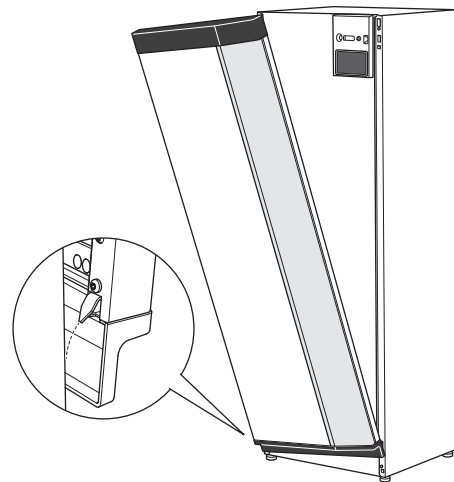

2. Hook the other corner in place.

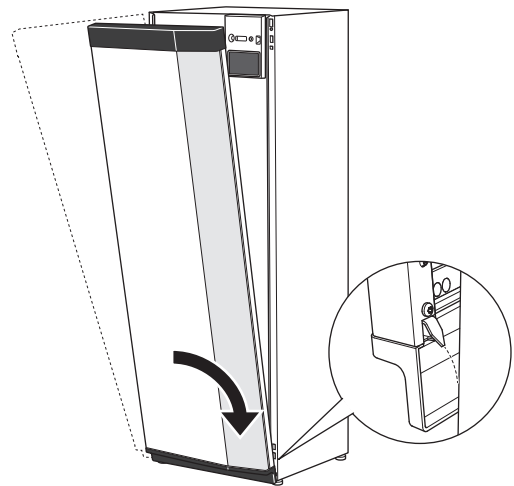

3. Check the display is straight. Adjust if necessary.

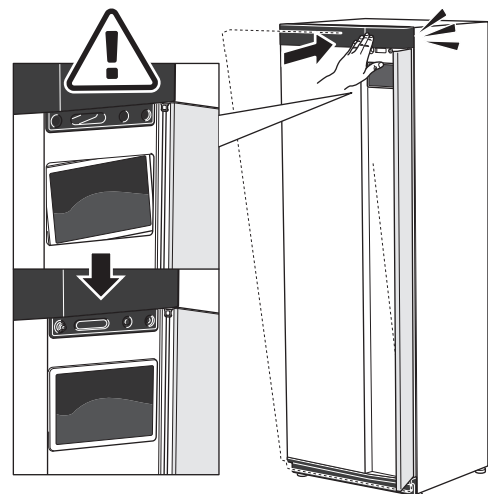

4. Press the top of the front section against the frame and screw it into place.

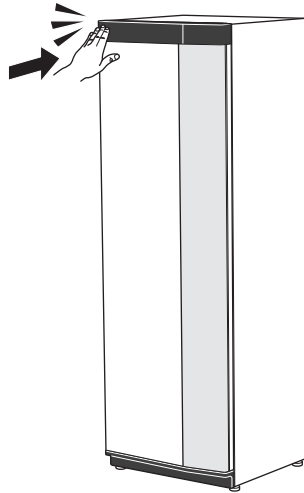

REMOVE SIDE PANEL

The side panels can be removed to facilitate the installation.

1. Remove the screws from the upper and lower edges.

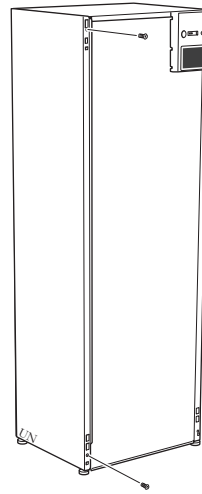

OPEN VENT COVER

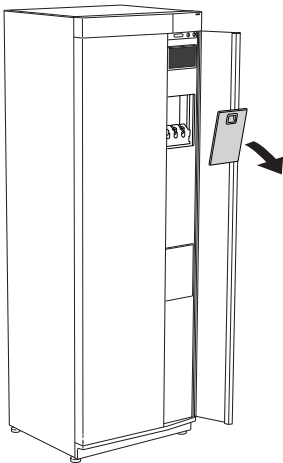

2. Twist the panel slightly outwards.

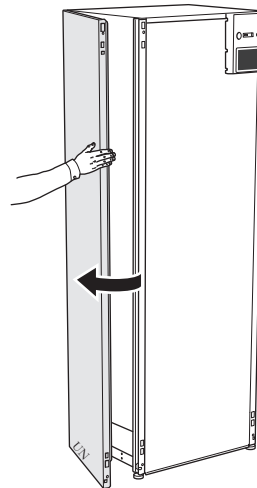

3. Move the panel outwards and backwards.

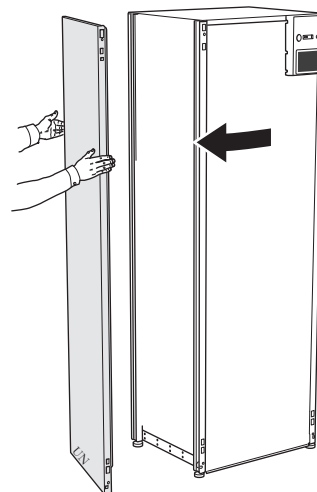

4. Assembly takes place in the reverse order.

Indoor module's design

General

1X230 V, STAINLESS STEEL

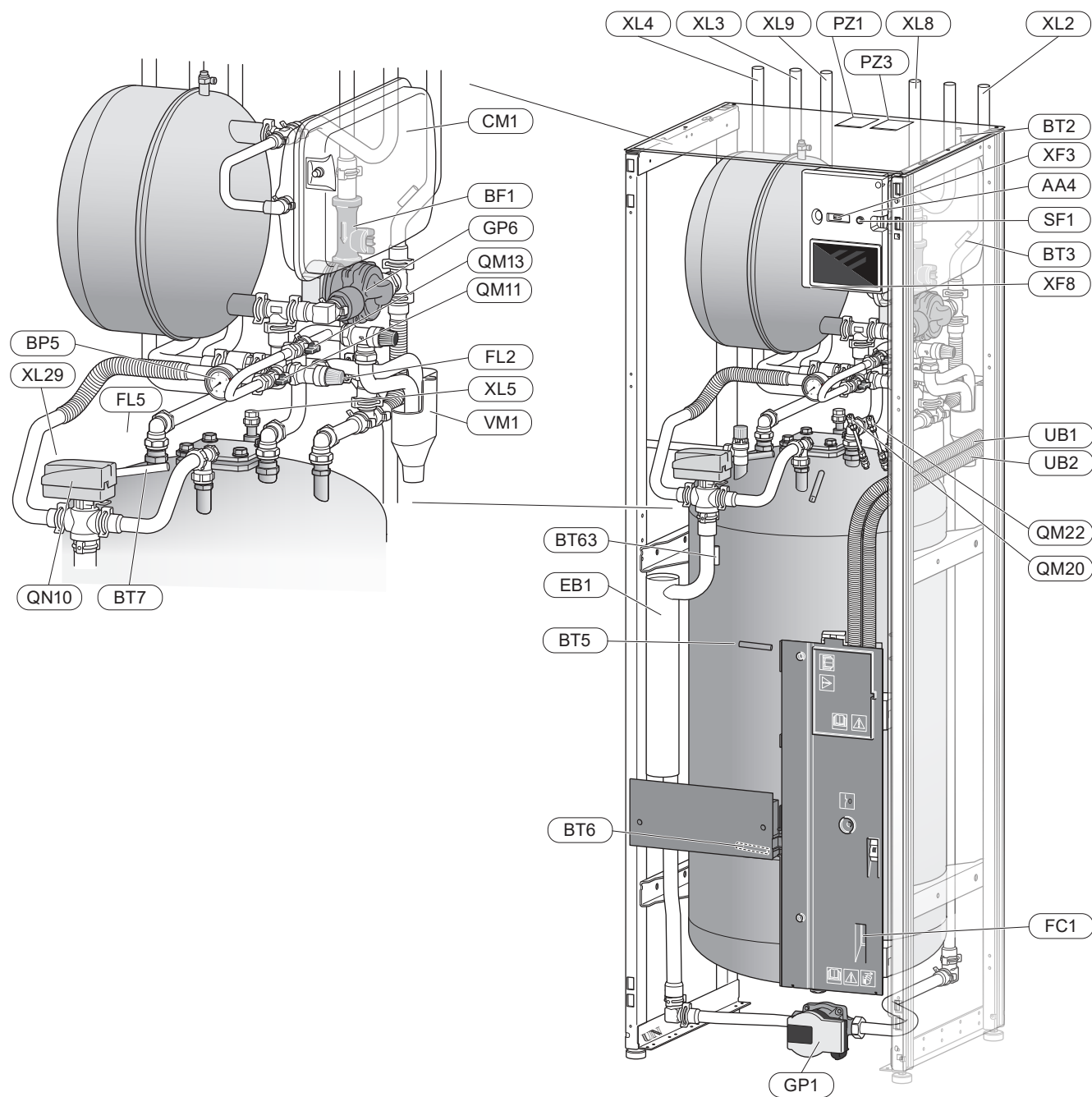

Pipe connections

XL1	Heating medium connection, supply
XL2	Heating medium connection, return
XL3	Cold water connection
XL4	Hot water connection
XL5	Hot water circulation connection
XL8	Docking connection, supply, from heat pump
XL9	Docking connection, return, to heat pump
XL29	T&P valve connection

HVAC components

CM1	Closed expansion vessel
FL2	Safety valve, heating medium
GP1	Circulation pump
GP6	Circ. pump 2
FL5	T&P valve
QM11	Filler valve, heating medium
QM13	Filler valve, heating medium
QM20	Venting valve, climate system
QM22	Venting valve, coil
QN10	Reversing valve, heating/hot water
WM1	Overflow cup

Sensors etc.

BF1	Flow meter
BP5	Pressure gauge, heating medium
BT2	Flow line sensor
BT3	Return line sensor
BT5	Controlling hot water sensor
BT6	Controlling hot water sensor
BT7	Display hot water sensor
BT63	Supply temperature sensor after additional heat

Electrical components

AA4	Display unit
EB1	Immersion heater
FC1	Miniature circuit breaker
SF1	On/off button
XF3	USB socket
XF8	Network connection for myUplink

Miscellaneous

PZ1	Rating plate
PZ3	Serial number
UB1-UB2	Cable gland

Designations according to standard EN 81346-2.

Distribution boxes

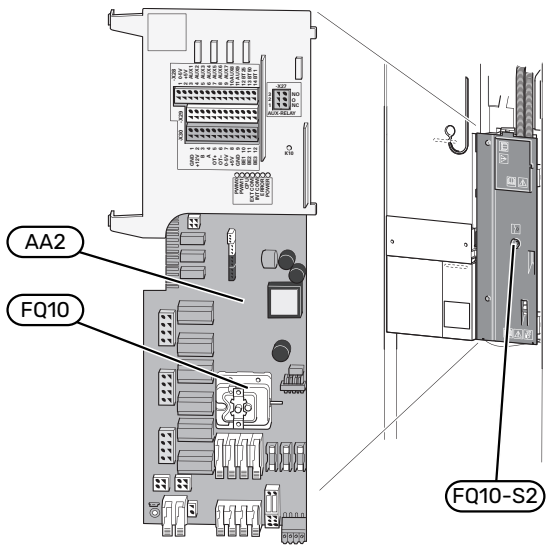

ELECTRICAL COMPONENTS

- AA2 Base card
- FQ10 Temperature limiter
- FQ10-S2 Reset button for temperature limiter

Pipe connections

General

Pipe installation must be carried out in accordance with current norms and directives.

The system requires the dimensions of the radiator circuit to be designed for a low temperature heating medium. At the lowest dimensioned outdoor temperature (DOT), the highest recommended temperatures are 55 °C on the supply line and 45 °C on the return line, but VVM S320 can handle up to 70 °C.

Caution

Ensure that incoming water is clean. When using a private well, it may be necessary to supplement with an extra water filter.



NOTE

Any high points in the climate system, must be equipped with air vents.



NOTE

The pipe systems need to be flushed out before the indoor module is connected so that any debris cannot damage component parts.



NOTE

Water may drip from the safety valve. A factory-fitted overflow pipe runs from the safety valve to an overflow cup. An overflow pipe has to be routed from the overflow cup to a suitable drain. The overflow pipe must be inclined along its entire length to prevent pockets where water can accumulate, and must be frost-proof.



NOTE

This installation is subject to building regulation approval, notify the local Authority of intention to install.



NOTE

Use only manufacturer's recommended replacement parts.

Waste water from the collection tray and from safety valves is led via an unpressurised overflow pipe to the drain, so hot water splashes cannot cause harm.

The mouth of the overflow pipe must be visible and not placed close to electrical components. In addition, the mouth of the overflow pipe (tundish), drain valves and motorised valves should also be positioned well away from all electrical components. This is the only permitted use of unpressurised overflow pipes. Overflow pipes from tundish (WM3) connected to the expansion relief valve (FL1) must also be connected to the drain in the same way.

The connection for the T&P valve (XL29) must not be used for any other purpose. Valves may not be positioned between the T&P valve (FL5) and the water heater.

Overflow pipes from tundish must be routed with a fall and be at least 300 mm long, before bends or angles in the pipework (see image) and must also be frost-proof.

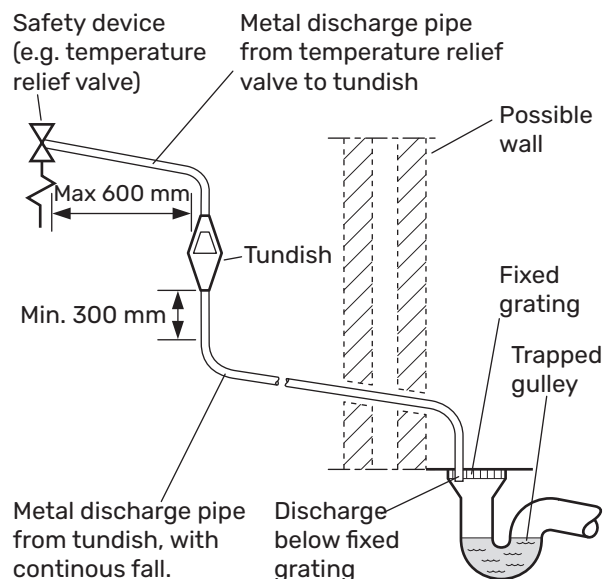

Valve outlet size	Minimum size of discharge pipe	Minimum size of discharge pipe from tundish	Maximum resistance allowed, expressed as a length of straight pipe (i.e. no elbows or bends)	Resistance created by each elbow or bend
G1/2	15 mm	22 mm	up to 9 m	0.8 mm
G1/2	15 mm	28 mm	up to 18 m	1.0 mm
G1/2	15 mm	35 mm	up to 27 m	1.4 mm
G3/4	22 mm	28 mm	up to 9 m	1.0 mm
G3/4	22 mm	35 mm	up to 18 m	1.4 mm

Valve outlet size	Minimum size of discharge pipe	Minimum size of discharge pipe from tundish	Maximum resistance allowed, expressed as a length of straight pipe (i.e. no elbows or bends)	Resistance created by each elbow or bend
G3/4	22 mm	42 mm	up to 27 m	1.7 mm
G1	28 mm	35 mm	up to 9 m	1.4 mm
G1	28 mm	42 mm	up to 18 m	1.7 mm
G1	28 mm	54 mm	up to 27 m	2.3 mm

Table sizing of copper discharge pipe for common temperature relief valve outlet sizes.

HARD WATER AREAS

Normally, there should not normally be any problem installing VVM S320 in hard water areas, as the operating temperature is 50–60°C.

CLEANING THE CLIMATE SYSTEM

When the water heater and the climate system have been filled with water, VVM S320 must operate at maximum normal temperature for at least one hour. Thereafter the system must be drained of water and refilled.

Before installing the heat pump in an existing system, it is important that the system is properly flushed through.

Even if the heat pump is to be installed in a new system, the heat pump and system should be flushed.



NOTE
Ensure that cleaning agent has been removed from the entire system before adding inhibitor.

After flushing an inhibitor should be used for long-term anti-corrosion protection.

NIBE Energy Systems Limited recommends water treatments, supplied by Fernox, specifically designed for heat pumps.

MINIMUM SYSTEM FLOWS



NOTE
An undersized climate system can result in damage to the product and lead to malfunctions.

Each climate system must be dimensioned individually to provide the recommended system flows.

The installation must be dimensioned to provide at least the minimum defrosting flow at 100 % circulation pump operation.

Air/water heat pump	Minimum flow during defrosting 100% circulation pump operation (l/s)	Minimum recommended pipe dimension (DN)	Minimum recommended pipe dimension (mm)
AMS 10-12/ HBS 05-12	0.29	20	22

Air/water heat pump	Minimum flow during defrosting 100% circulation pump operation (l/s)	Minimum recommended pipe dimension (DN)	Minimum recommended pipe dimension (mm)
AMS 20-6/ HBS 20-6	0.19	20	22
AMS 20-10/ HBS 20-10			

Air/water heat pump	Minimum flow during defrosting 100% circulation pump operation (l/s)	Minimum recommended pipe dimension (DN)	Minimum recommended pipe dimension (mm)
F2040-12	0.29	20	22

Air/water heat pump	Minimum flow during defrosting 100% circulation pump operation (l/s)	Minimum recommended pipe dimension (DN)	Minimum recommended pipe dimension (mm)
F2120-8 (1x230V)	0.27	20	22
F2120-12 (1x 30 V)	0.35	25	28

Air/water heat pump	Minimum flow during defrosting 100% circulation pump operation (l/s)	Minimum recommended pipe dimension (DN)	Minimum recommended pipe dimension (mm)
S2125-8 (1x230 V)	0.32	25	28
S2125-12 (1x230 V)			

SYSTEM VOLUME

VVM S320 is equipped with an expansion vessel (CM1).

The volume of the expansion vessel is 10 litres and it is pre-pressurised as standard to 0.5 bar. As a result, the maximum permitted height "H" between the expansion vessel and the highest installed radiator is 5 m, see figure.

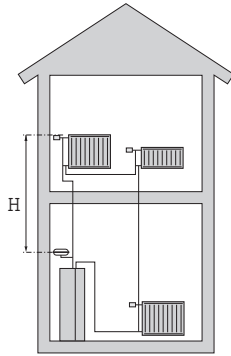

If the pre-pressure is not high enough, it can be increased by filling with air via the valve in the expansion vessel. Any change in the pre-pressure affects the ability of the expansion vessel to handle the expansion of the water.

The maximum system volume, excluding VVM S320, is 220 litres at the above-mentioned pre-pressure.

SYMBOL KEY

Symbol	Meaning
	Shut-off valve
	Tapping valve
	Non-return valve
	Mixing valve
	Circulation pump
	Immersion heater
	Expansion vessel
	Filterball
	Safety valve
	T&P valve
	Trim valve
	Pressure reduction valve
	Tundish
	Reversing valve/shunt
	Overflow valve
	Domestic hot water
	Outdoor module
	Hot water circulation
	Heating system
	Heating system with lower temperature

SYSTEM DIAGRAM

VVM S320 consists of a water heater with charge coil, expansion vessel, immersion heater, circulation pumps, buffer vessel and control system. VVM S320 connects to the climate system.

VVM S320 is intended for connection and communication with a compatible NIBE outdoor unit, and together they constitute a complete heating installation.

When it is cold outdoors, the outdoor unit works with the indoor module, and if the outdoor air temperature falls below the outdoor unit's working range, all heating is performed by the immersion heater.

Requisite safety equipment connected to NIBE air/water heat pump and VVM S320, see section, docking.

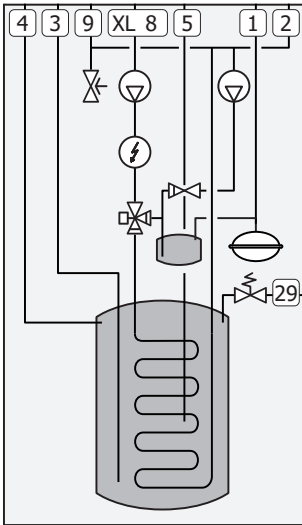

XL1	Connection, heating medium flow line
XL2	Connection, heating medium return line
XL3	Connection, cold water
XL4	Connection, hot water
XL8	Connection, docking from heat pump
XL9	Connection, docking to heat pump
XL29	Connection, T&P valve



Caution

This is a principle of operation. For more detailed information about VVM S320, see section "Indoor module's design".

Dimensions and pipe connections

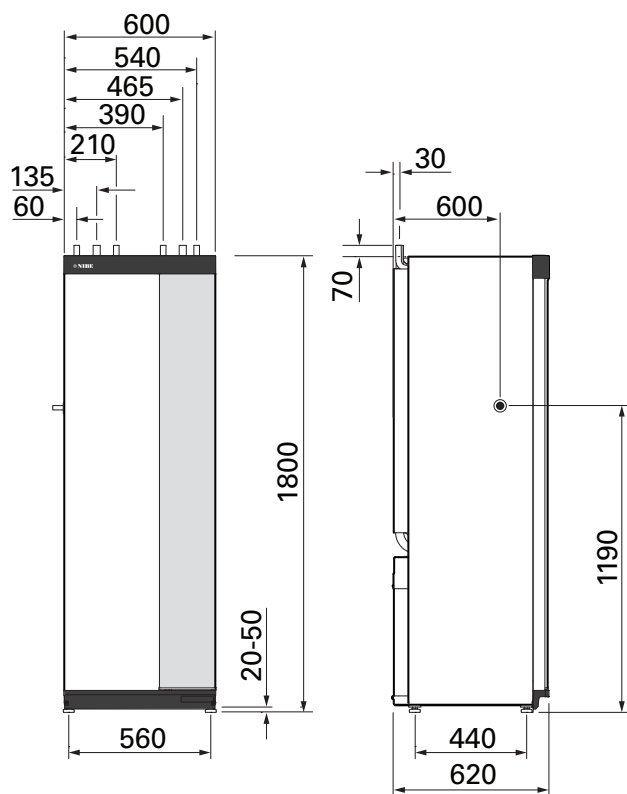
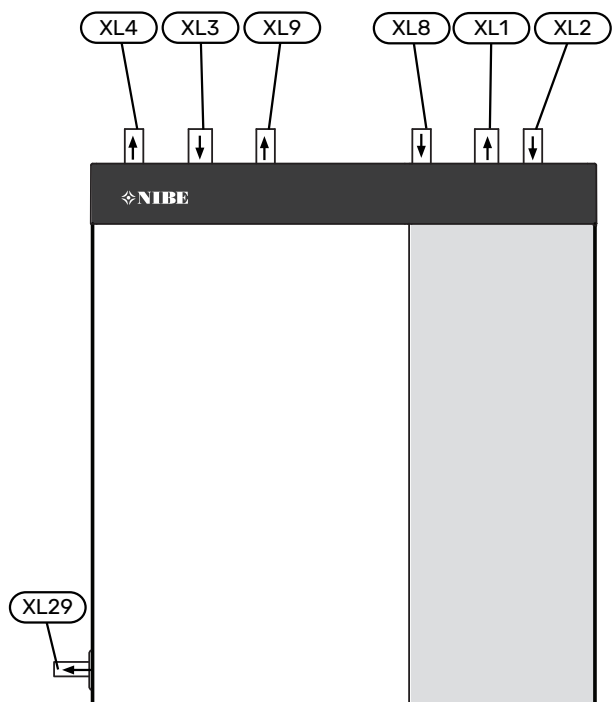

PIPE DIMENSIONS

Connection			
XL1 / XL2	Heating medium supply/return \varnothing	mm	22
XL3 / XL4	Cold/hot water \varnothing	mm	22
XL8 / XL9	Docking connection, supply (from heat pump) / Docking connection, return (to heat pump) \varnothing	mm	22
XL29	T&P valve \varnothing	mm	15

Connecting to air/water heat pump

NIBE recommends installing VVM S320 as close to the heat pump as possible to obtain the optimum comfort.

You can find a list of compatible air/water heat pumps in section "Compatible outdoor modules".

Caution

Also, consult the Installer Manual for your air/water heat pump.

Install as follows:

- pressure relief valve
Some heat pump models have a factory-fitted safety valve.
- drain valve
For draining the heat pump during prolonged power failures. Only for heat pumps that do not have a gas separator.
- non-return valve
A non-return valve is only required in those installations where the placement of the products in relation to each other can cause self-circulation.
If the heat pump is already fitted with a non-return valve, there is no need to install another.
- shut-off valve
To facilitate any future servicing.
- filterball or particle filter
Installed before connection "heating medium return" (XL2) (the lower connection) on the vacuum pump.
In installations with a particle filter, the filter is combined with an additional shut-off valve.

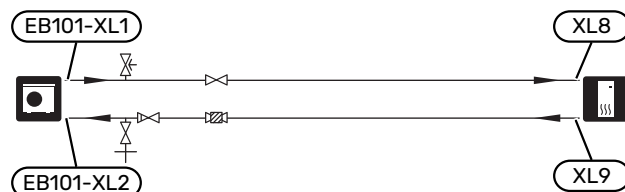

Use without heat pump

The indoor unit can be used without a heat pump, i.e. solely as an electric boiler, for example to produce heat and hot water before the heat pump is installed.

To use the indoor unit as an electric boiler, you need:

1. connect the pipe for docking coming in from the heat pump (XL8) with the pipe out to the heat pump (XL9)
2. To make software settings according to section "Commissioning without heat pump".

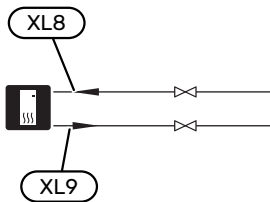

Climate system

A climate system is a system that regulates the indoor temperature with the help of the control system in VVM S320 and, for example, radiators, underfloor heating, underfloor cooling, fan coils, etc.

CONNECTING THE CLIMATE SYSTEM

Install as follows:

- When connecting to a system with thermostats, either a bypass valve must be fitted or, alternatively, some of the thermostats must be removed to ensure there is sufficient flow and heat emission.

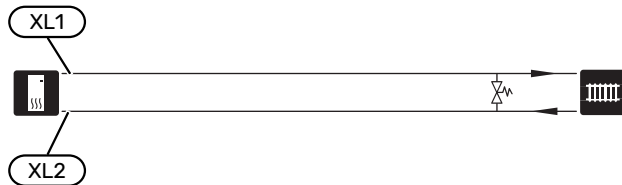

Cold and hot water

The settings for hot water are made in menu 7.1.1 - "Hot water".

Stop temperature for hot water must be at least 60°C.

CONNECTING COLD AND HOT WATER

Install as follows:

- shut-off valve
- mixing valve

A mixing valve must be installed when the factory setting for hot water is changed. National regulations must be observed.
- enclosed valve connector containing pressure relief valve (QN17), expansion relief valve (FL1) and non-return valve (RM1)
- enclosed expansion vessel (CM4)

The expansion vessel (CM4) accommodates expansion that results from heating the water inside the unit. The expansion vessel must be connected between the expansion relief valve (FL1) and the water heater. The location of the expansion vessel should allow access to recharge the pressure when necessary.

- enclosed tundish (WM3)

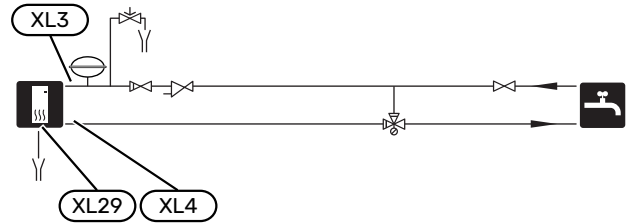

Installation alternative

VVM S320 can be installed in several different ways, some of which are shown here.

Further option information is available at nibe.co.uk and in the respective assembly instructions for the accessories used. See page 65 for a list of the accessories that can be used with VVM S320.

EXTRA CLIMATE SYSTEM

In buildings with several climate systems that require different supply temperatures, the accessory ECS 40/ECS 41 can be connected.

A shunt valve then lowers the temperature to the underfloor heating system, for example.

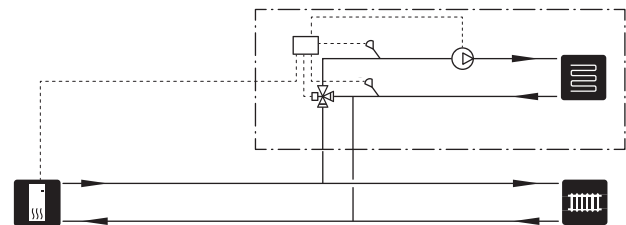

EXTRA HOT WATER HEATERS

The system should be supplemented with an extra water heater, if a large bath tub or other significant consumer of hot water is installed.

Water heater with immersion heater

In a water heater with an immersion heater, the water is initially heated by the heat pump. The immersion heater in the water heater is used for keeping warm and when the heat pump does not have sufficient power.

The water heater's flow is connected after VVM S320.

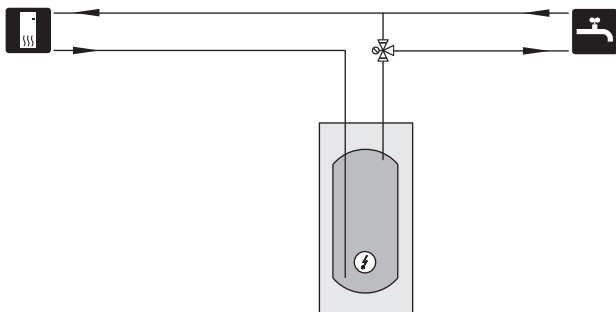

HOT WATER CIRCULATION

A circulation pump can be controlled by VVM S320 to circulate the hot water. The circulating water must have a temperature that prevents bacterial growth and scalding, and national standards must be satisfied.

The HWC return can be connected to XL5 or a freestanding water heater. If an electric water heater is connected after the heat pump, the HWC return must be connected to the water heater.

The expansion vessel (CM4) that is enclosed VVM S320 may need to be replaced with a larger one.

The circulation pump is activated via the AUX output in menu 7.4 - "Selectable in/outputs".

HWC can be supplemented with a hot water sensor for HWC (BT70) and (BT82), which is connected via the AUX input and activated in menu 7.4 - "Selectable in/outputs".

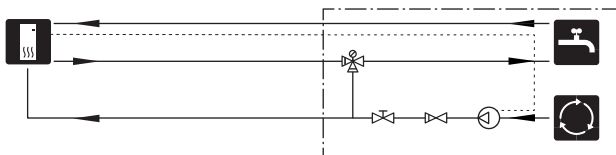

Electrical connections

General

All electrical equipment, except the outdoor temperature sensors and room temperature sensors are ready connected at the factory.

- Electrical installation and wiring must be carried out in accordance with national provisions.
- Disconnect VVM S320 before insulation testing the house wiring.
- If the building is equipped with an earth-fault breaker, VVM S320 should be equipped with a separate one.
- VVM S320 must be installed via an isolator switch. The cable area has to be dimensioned based on the fuse rating used.
- If a miniature circuit breaker is used, this must have at least triggering characteristic "C". See section "Technical specifications" for fuse size.
- Use a screened cable for communication with the heat pump.
- To prevent interference, communication cables to external connections must not be laid in the vicinity of high voltage cables.
- The minimum area of communication and sensor cables to external connections must be 0.5 mm² up to 50 m, for example EKKX, LiYY or equivalent.
- For an electrical wiring diagram for VVM S320, see the "Technical specifications" section.
- When routing a cable into VVM S320, the cable grommets (UB1) and (UB2) must be used.

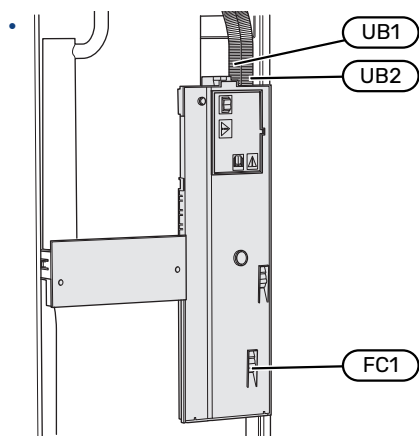

NOTE

If the supply cable is damaged, only NIBE, its service representative or similar authorised person may replace it to prevent any danger and damage.



NOTE

Check the connections, main voltage and phase voltage before the machine is started to prevent damage to the indoor module's electronics.



NOTE

Do not start the system before filling up with water. Components in the system could be damaged.

MINIATURE CIRCUIT-BREAKER

The operating circuit in VVM S320 and some of its internal components are fused internally by a miniature circuit breaker (FC1).

Only VVM S320 1x230 V.



NOTE

Electrical installation and any servicing must be carried out under the supervision of a qualified electrician. Disconnect the current using the circuit breaker before carrying out any servicing.

ACCESSIBILITY, ELECTRICAL CONNECTION

Removing the cover

The hatch is opened using a screwdriver.

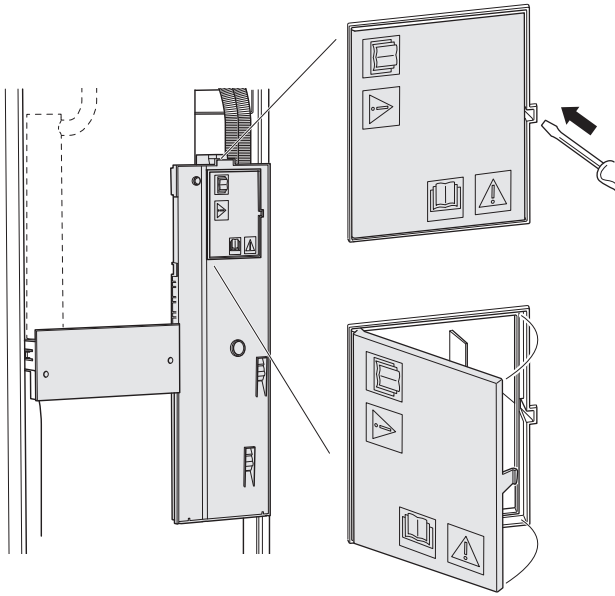

Removing the covers

The cover is opened using a screwdriver.

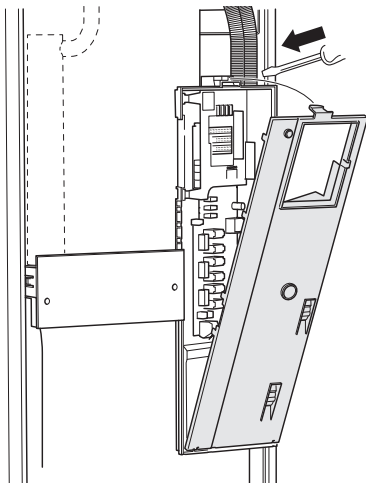

CABLE LOCK

Use a suitable tool to release/lock cables in the indoor module terminal blocks.

Terminal block

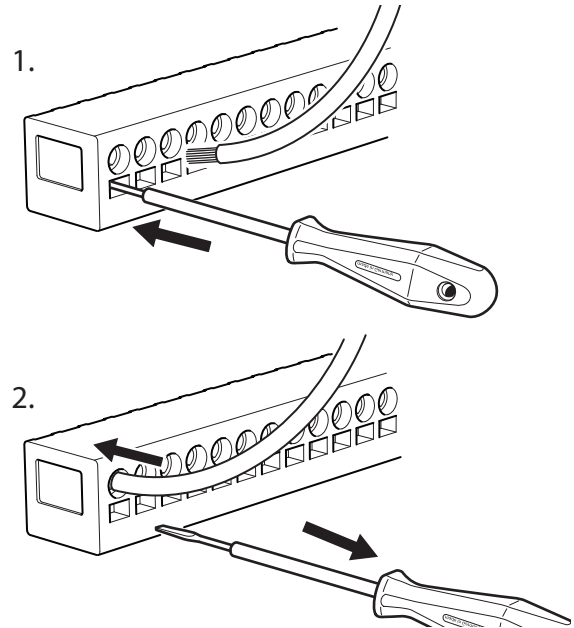

TEMPERATURE LIMITER

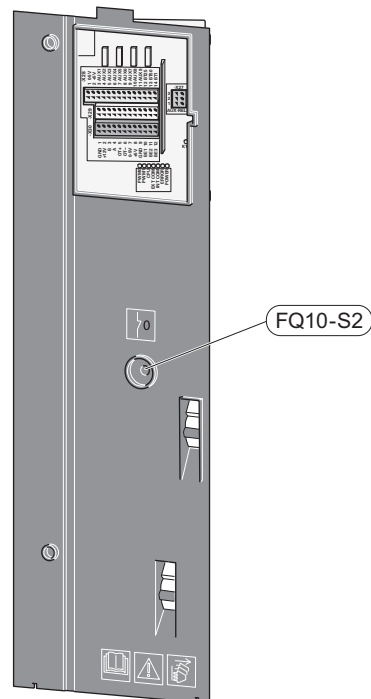

The temperature limiter (FQ10) cuts the power supply to the electric additional heat if the temperature rises above 89 °C and it is reset manually.

Resetting

The temperature limiter (FQ10) is accessed behind the front cover. Reset the temperature limiter by pressing its button (FQ10-S2).

Connections

TERMINAL BLOCKS

The following terminal blocks are used on the base board (AA2).

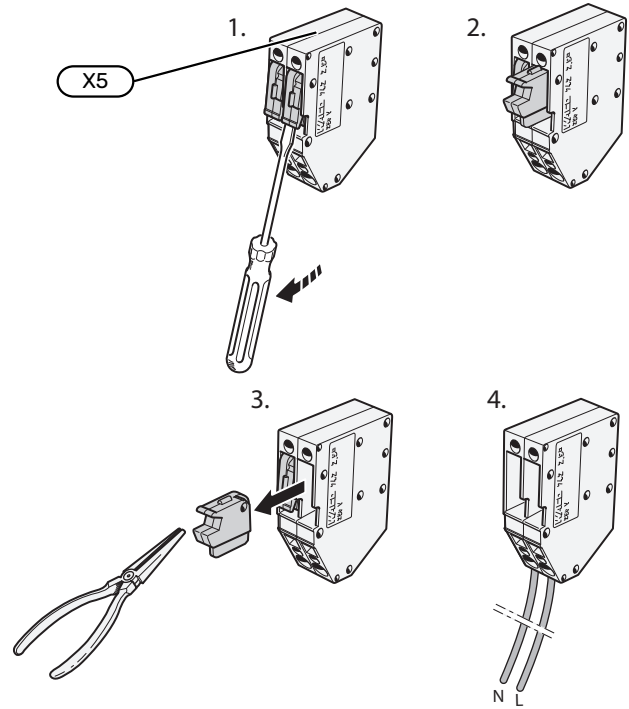
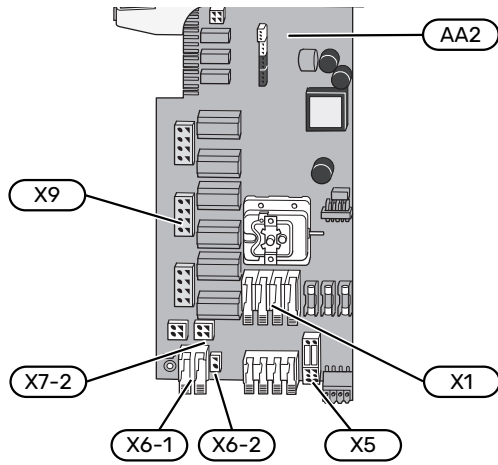

POWER CONNECTION

Supply voltage

Enclosed cable for incoming supply electricity is connected to terminal block X1 and X6-1 on the PCB (AA2).

Connection 1x230 V

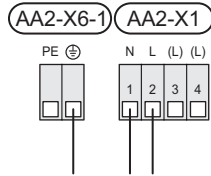

External control voltage for the control system

If the control system will be powered separately from other components in the indoor module (e.g. for tariff control), a separate operating cable must be connected.

NOTE

During service, all supply circuits must be disconnected.

Remove the bridges from terminal block X5.

Control voltage (230 V ~ 50Hz) connects to AA2:X5:N, X5:L and X6-2 (PE).

Enclosed label

The enclosed label is placed on the electrical connection's cover.

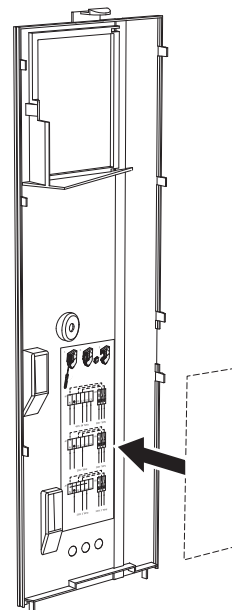

EXTERNAL CONNECTIONS

Connect external connections on terminal blocks X28, X29 and X30 on the base board (AA2).

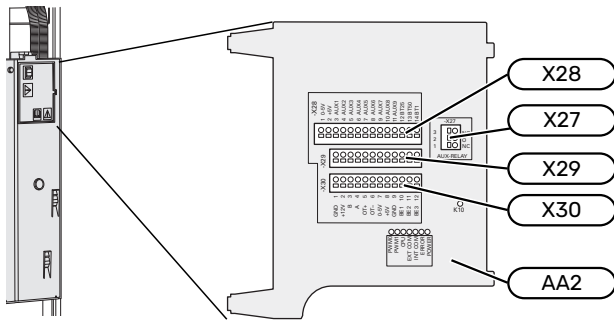

Sensors

Outside sensor

The outdoor temperature sensor (BT1) is placed in the shade on a wall facing north or north-west, so it is unaffected, for example, by the morning sun.

Connect the outdoor temperature sensor to terminal block AA2-X28:14 and AA2-X29:GND.

If a conduit is used it must be sealed to prevent condensation in the sensor capsule.

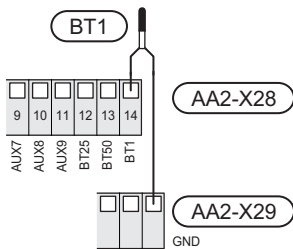

External supply temperature sensor

If an external supply temperature sensor (BT25) needs to be used, connect it to terminal block AA2-X28:12 and to terminal block AA2-X29:GND.

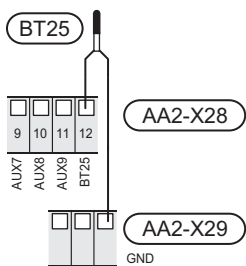

Room sensor

VVM S320 is supplied with an enclosed room sensor (BT50) that makes it possible to display and control the room temperature in the display on VVM S320.

Fit the room sensor in a neutral position where a set temperature is required. A suitable location might be, for example, on a free inner wall in a hall approx. 1.5 m above the floor. It is important that the room sensor is not obstructed from measuring the correct room temperature, for example by being located in a recess, between shelves, behind a curtain,

above or close to a heat source, in a draught from an external door or in direct sunlight. Closed radiator thermostats can also cause problems.

VVM S320 operates without room sensor, but if you want to read the home's indoor temperature from the display on VVM S320, the room sensor must be fitted. Connect the room sensor to terminal block X28:13 and AA2-X29:GND.

If a room sensor is to be used to change the room temperature in °C and/or to fine-tune the room temperature, the sensor must be activated in menu 1.3 - "Room sensor settings".

If a room sensor is used in a room with underfloor heating, it should only have an indicative function, not control of the room temperature.

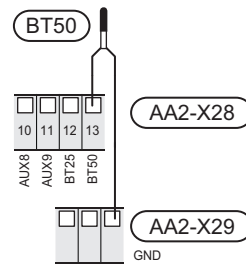

Caution

Changes of temperature in accommodation take time. For example, short time periods in combination with underfloor heating will not give a noticeable difference in room temperature.

Pulse energy meter

Up to two electricity meters or energy meters for heating (BE6, BE7) can be connected to VVM S320 via terminal blocks AA2-X28:1-2 and AA2-X30:7-8.



Caution

The EMK accessory is connected to the same terminal blocks as electricity meters/energy meters.

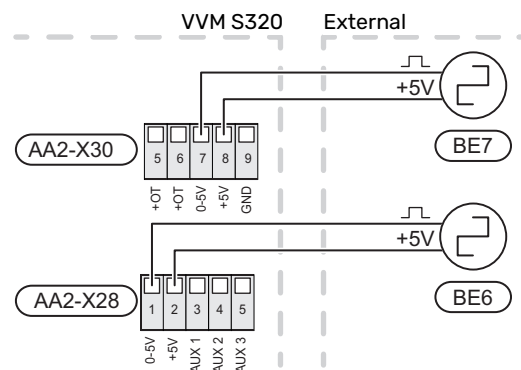

Activate the meter(s) in menu 7.2 - "Accessory settings" and then set the desired value ("Energy per pulse" or "Pulses per kWh") in menu 7.2.19 - "Pulse energy meter".

Load monitor

Integrated load monitor

VVM S320 is equipped with a simple form of integrated load monitor, which limits the power steps for the electric additional heat by calculating whether future power steps can be connected to the relevant phase without exceeding the current for the specified main fuse.

If the current would exceed the specified main fuse, the power step is not permitted. The size of the property's main fuse is specified in menu 7.1.9 - "Load monitor".

COMMUNICATION

Outdoor module

When the air/water heat pump is to be connected to VVM S320, this is connected to terminal block X30:1 (GND), X30:3 (B) and X30:4 (A) on the base board AA2.

VVM S320 and F2040/NIBE SPLIT HBS

VVM S320

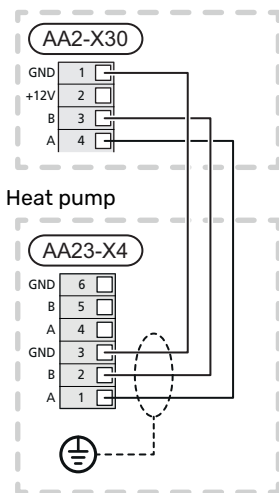

VVM S320 and S2125/F2120

VVM S320

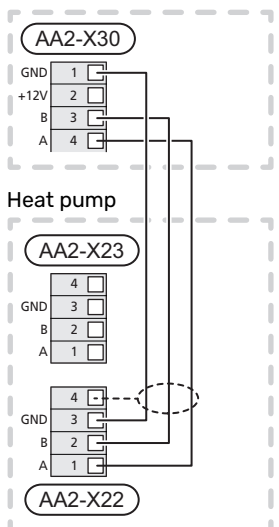

Connecting accessories

Instructions for connecting accessories are provided in the manual accompanying the accessory. See section "Accessories" for a list of the accessories that can be used with VVM S320. Connection for communication with the most common accessories is shown here.

Accessories with accessory board (AA5)

Accessories with accessory board (AA5) connect to terminal block AA2-X30:1, 3, 4 in VVM S320.

If several accessories are to be connected, or are already installed, the boards are connected in series.

Because there can be different connections for accessories with accessory board (AA5), you should always read the instructions in the manual for the accessory that is to be installed.

VVM S320

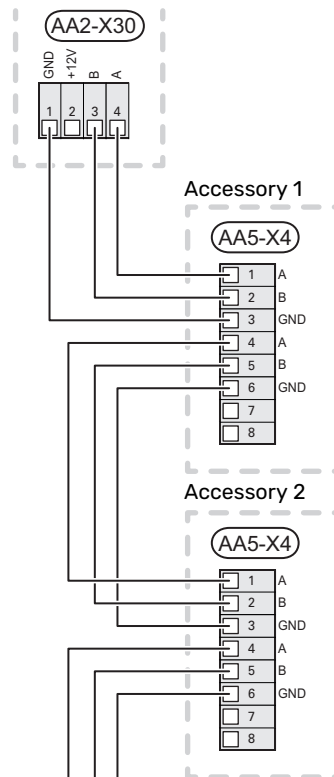

Network cable for myUplink (W130)

In instances when you want to connect to myUplink using a network cable instead of via wifi.

1. Connect the shielded network cable to the display.
2. Route the network cable to the top of VVM S320.
3. Follow the flow meter's cable out at the rear.

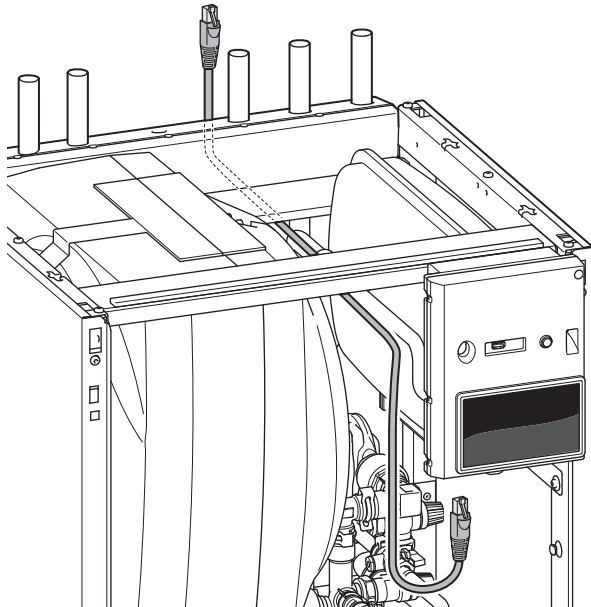

SELECTABLE IN/OUTPUTS

VVM S320 has software-controlled AUX inputs and outputs for connecting the external switch function (contact has to be potential-free) or sensor.

In menu 7.4 - "Selectable in/outputs", you select the AUX connection to which each function has been connected.

For certain functions, accessories may be required.



TIP

Some of the following functions can also be activated and scheduled via menu settings.

Selectable inputs

Selectable inputs on the base board (AA2) for these functions are AA2-X28:3-11. Each function connects to any input and GND (AA2-X29).

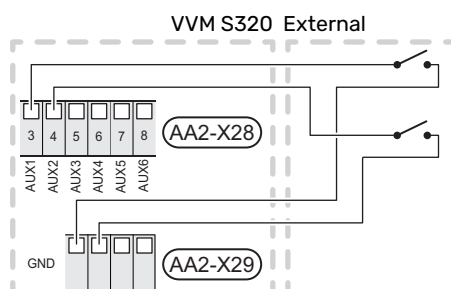

The example above uses the inputs AUX1 (AA2-X28:3) and AUX2 (AA2-X28:4).

Selectable outputs

A selectable output is AA2-X27.

The output is a potential-free switching relay.

If VVM S320 is switched off or in emergency mode, the relay is in C-NC position.

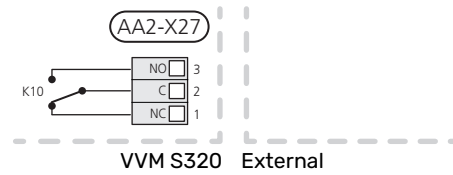

Caution

The relay output may be subjected to a max load of 2 A at resistive load (230 V~).



TIP

The AXC accessory is required if more than one function is to be connected to the AUX output.

Possible selection for AUX inputs

Temperature sensor

Available options are:

- cooling/heating/hot water, determines when it is time to switch between cooling, heating and hot water mode (selectable when the air/water heat pump is permitted to produce cooling).
- displayed hot water sensor for HWC (BT70). Placed on the supply line.
- displayed hot water sensor for HWC (BT82). Placed on the return line.
- six dedicated sensors (BT37.1 – BT37.6) for placing wherever you want.

Monitor

Available options are:

- alarm from external units.
The alarm is connected to the control, which means that the malfunction is shown as an information message in the display. Potential free signal of type NO or NC.
- stove monitor for accessory ERS.
Stove monitor is a thermostat that is connected to the chimney. When the negative pressure is too low, the fans in ERS (NC) are switched off.

External activation of functions

An external switch function can be connected to VVM S320 to activate various functions. The function is activated during the time the switch is closed.

Possible functions that can be activated:

- hot water demand mode "More hot water"

- hot water demand mode "Small"
- "External adjustment"

When the switch is closed, the temperature is changed in °C (if a room sensor is connected and activated). If a room sensor is not connected or not activated, the desired change of "Temperature" ("Offset") is set with the number of steps selected. The value is adjustable between -10 and +10. Setting the value for the change is performed in menu 1.30.3 - "External adjustment".

- activation of one of four fan speeds.

(Can be selected if ventilation accessory is activated.)

The following options are available:

- "Activate fan speed 1 (NO)" - "Activate fan speed 4 (NO)"
- "Activate fan speed 1 (NC)"

The fan speed is activated during the time the switch is closed. Normal speed is resumed when the switch is opened again.

- SG ready



Caution

This function can only be used in mains networks that support the "SG Ready" standard.

"SG Ready" requires two AUX inputs.

In cases where this function is required, it must be connected to terminal block X28 on the base board (AA2).

"SG Ready" is a smart form of tariff control, through which your electricity supplier can affect the indoor, hot water and/or pool temperatures (if applicable) or simply block the additional heating and/or the compressor in the heat pump at certain times of the day (can be selected in menu 4.2.3 after the function has been activated). Activate the function by connecting potential-free switch functions to two inputs selected in menu 7.4 - "Selectable in/outputs" (SG Ready A and SG Ready B).

Closed or open switch means one of the following:

- *Blocking (A: Closed, B: Open)*

"SG Ready" is active. The compressor in the air/water heat pump and additional heat are blocked in the same way as current tariff blocking.

- *Normal mode (A: Open, B: Open)*

"SG Ready" is not active. No effect on the system.

- *Low price mode (A: Open, B: Closed)*

"SG Ready" is active. The system focuses on costs savings and can for example exploit a low tariff from the electricity supplier or over-capacity from any own power source (effect on the system can be adjusted in the menu 4.2.3).

- *Overcapacity mode (A: Closed, B: Closed)*

"SG Ready" is active. The system is permitted to run at full capacity at over capacity (very low price) with the electricity supplier (effect on the system is settable in menu 4.2.3).

(A = SG Ready A and B = SG Ready B)

External blocking of functions

An external switch function can be connected to VVM S320 for blocking various functions. The switch must be potential-free and a closed switch results in blocking.



NOTE

Blocking entails a risk of freezing.

Functions that can be blocked:

- heating (blocking of heating demand)
- hot water (hot water production). Any hot water circulation (HWC) remains in operation.
- compressor in heat pump (EB101)
- internally controlled additional heat
- tariff blocking (additional heat, compressor, heating, cooling and hot water are disconnected)

Possible selections for AUX output

Indications

- alarm
- common alarm
- cooling mode indication
- delayed cooling mode indication
- holiday
- away mode
- low electricity price (Smart Price Adaption)

Control

- circulation pump for hot water circulation
- external heating medium pump



NOTE

The relevant distribution box must be marked with a warning about external voltage.

Connecting external circulation pump

An external circulation pump is connected to the AUX output, as illustrated below.

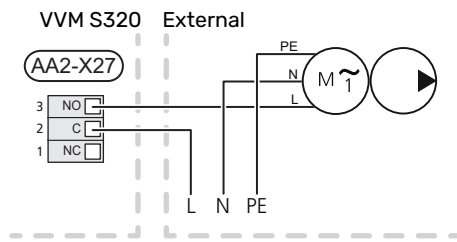

Settings

ELECTRICAL ADDITION - MAXIMUM OUTPUT

The immersion heater is set at the factory to max power.

The immersion heater's power is set in menu 7.1.5.1 - "Int elec add heat".

Power steps of the immersion heater

The table(s) displays the total phase current for the immersion heater.

1x230 V (maximum electrical power, connected on delivery 7 kW)

Electrical addition (kW)	Max L1 (A)
0	0.0
1	4.3
2	8.7
3	13.0
4	17.4
5	21.7
6	26.1
7 ¹	30.4

¹ Factory setting

EMERGENCY MODE

Emergency mode is used in event of operational interference and in conjunction with service.

When VVM S320 is put into emergency mode, the system works as follows:

- VVM S320 prioritises heating production.
- Hot water is produced if possible.
- Max output for the immersion heater in emergency mode, limited according to the setting in menu 7.1.8.2 - "Emergency mode".
- Fixed supply temperature if the system has no value from the outdoor temperature sensor (BT1).

When the emergency mode is active, the status lamp is yellow.

You can activate the emergency mode both when VVM S320 is running and when it is switched off.

To activate when VVM S320 is running: press and hold the on/off button (SF1) for 2 seconds and select "emergency mode" from the shutdown menu.

To activate emergency mode when VVM S320 is switched off: press and hold the on/off button (SF1) for 5 seconds. (Deactivate the emergency mode by pressing once.)

Commissioning and adjusting

Preparations



NOTE

Do not start VVM S320 if there is a risk that the water in the system has frozen.



Caution

Check the miniature circuit-breaker (FC1). It may have tripped during transport.

1. Check that VVM S320 is closed.
2. Check that the externally installed draining valve is fully closed and that the temperature limiter (FQ10) has not tripped. See section "Temperature limiter".

Filling and venting

FILLING THE HOT WATER HEATER

1. Open a hot water tap in the house.
2. Fill the hot water heater through the cold water connection (XL3).
3. When the water that comes out of the hot water tap is no longer mixed with air, the water heater is full and the hot water tap can be closed.

FILLING THE CLIMATE SYSTEM

1. Open the vent valves (QM20, QM22).
2. Open the filling valves (QM11, QM13). VVM S320 and fill the climate system with water.
3. When the water exiting the vent valves (QM20, QM22) is no longer mixed with air, close the valves.
4. After a while, the pressure begins to rise on the pressure gauge (BP5). When the pressure reaches 2.5 bar (0.25 MPa), the safety valve (FL2) starts to release water. Close the filling valves (QM11, QM13).
5. Reduce the climate system pressure to the normal working range (approx. 1 bar) by opening the vent valves (QM20, QM22) or the safety valve (FL2).

VENTING THE CLIMATE SYSTEM



Caution

Insufficient venting can damage internal components in VVM S320.

1. Turn off VVM S320 using the on/off button (SF1).
2. Vent VVM S320 through the vent valves (QM20, QM22) and other climate systems through their relevant vent valves.

3. Keep topping up and venting until all air has been removed and the pressure is correct.

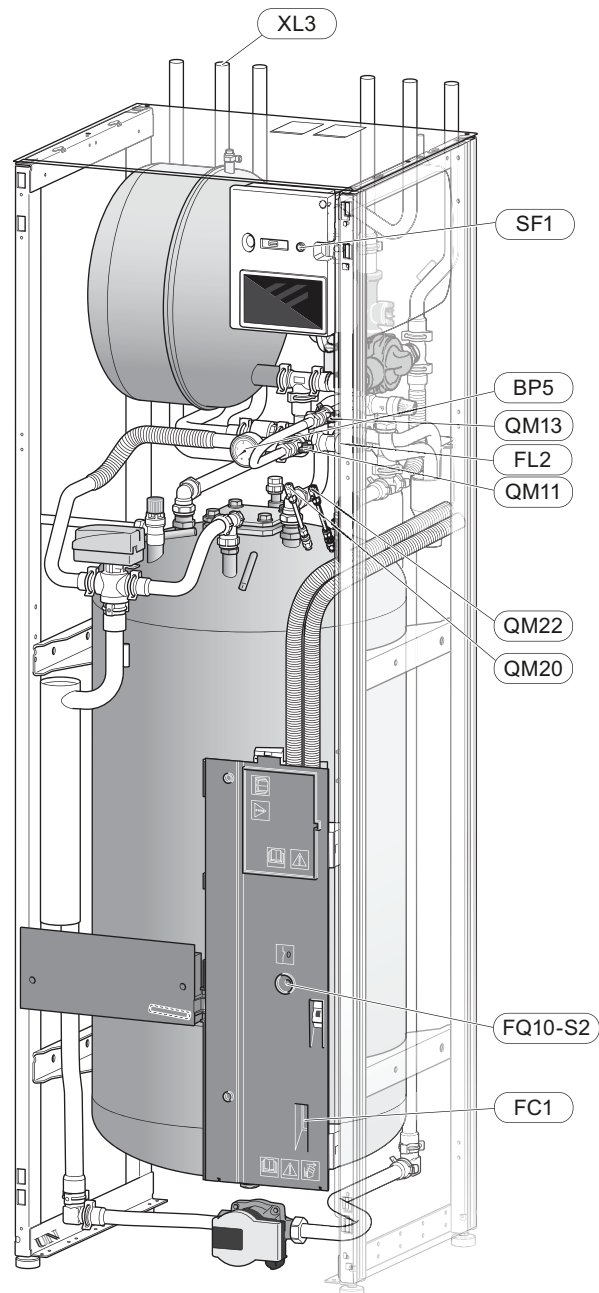

Start-up and inspection

START GUIDE



NOTE

There must be water in the climate system before VVM S320 is started.

1. Power the heat pump.
2. Start VVM S320 by pressing the on/off button (SF1).
3. Follow the instructions in the display's start guide. If the start guide does not start when you start the VVM S320, you can start it manually in menu 7.7.



TIP

See the section "Control - Introduction" for a more detailed introduction to the installation's control system (operation, menus, etc.).

Commissioning

The first time the installation is started a start guide is started. The start guide instructions state what needs to be carried out at the first start together with a run through of the installation's basic settings.

The start guide ensures that the start-up is carried out correctly and, for this reason, cannot be skipped.



Caution

As long as the start guide is active, no function in VVM S320 will start automatically.

Operation in the start guide

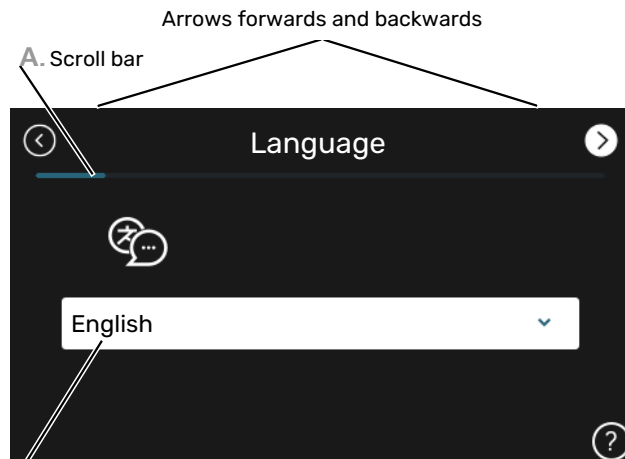

B. Option / setting

A. Scroll bar

Here you can see how far you have come in the start guide.

Drag to the right or left with your finger to browse between the pages.

You can also press the arrows in the top corners to browse.

B. Option / setting

Make settings for the system here.

COMMISSIONING WITHOUT HEAT PUMP

The indoor unit can be used without a heat pump, i.e. solely as an electric boiler, for example to produce heat and hot water before the heat pump is installed.

1. Go to menu 4.1 - "Operating mode" and select "Add. heat only".
2. Go to menu 7.3.2 - "Installed heat pump" and deactivate the heat pump..



Caution

When commissioning without NIBE outdoor unit the "communication error" alarm may appear in the display.

The alarm is reset if the relevant heat pump is deactivated in menu 7.3.2 - "Installed heat pump"



NOTE

Select operating mode "Auto" or "Manual" when the indoor unit is once again to be used with the outdoor unit.

PUMP SPEED

The heating medium pump (GP1) in VVM S320 is frequency controlled and adjusts automatically using control and based on heating demand.

Available pressure, heating medium pump

Available pressure (kPa)

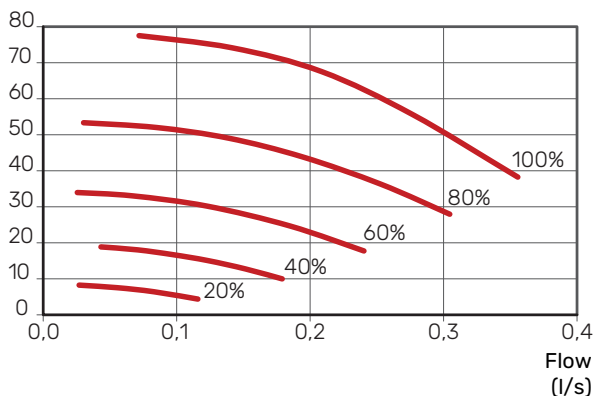

Setting the cooling/heating curve

In the menus "Curve, heating" and "Curve, cooling", you can see the heating and cooling curves for your house. The purpose of the curves is to provide an even indoor temperature, regardless of the outdoor temperature, and thereby energy-efficient operation. Based on these curves, VVM S320 determines the temperature of the water to the climate system (the supply temperature) and thus the indoor temperature.

CURVE COEFFICIENT

The slopes of the heating /cooling curves indicate how many degrees the supply temperature is to be increased/reduced when the outdoor temperature drops/increases. A steeper slope means a higher supply temperature for heating or a lower supply temperature for cooling at a certain outdoor temperature.

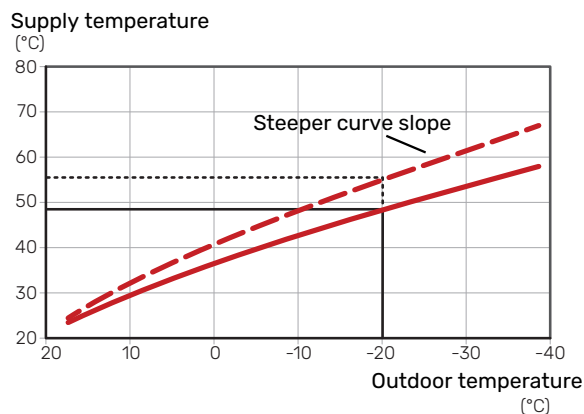

The optimum curve slope depends on the climate conditions in your location, whether the house has radiators, fan coils or underfloor heating and how well insulated the house is.

The heating/cooling curves are set when the heating/cooling system is installed, but may need adjusting later. Thereafter, the curves should not need further adjustment.

CURVE OFFSET

An offset of the heating curve means that the supply temperature changes by the same amount for all outdoor temperatures, e.g. a curve offset of +2 steps increases the supply temperature by 5 °C at all outdoor temperatures. A corresponding change to the cooling curve results in a lowering of the supply temperature.

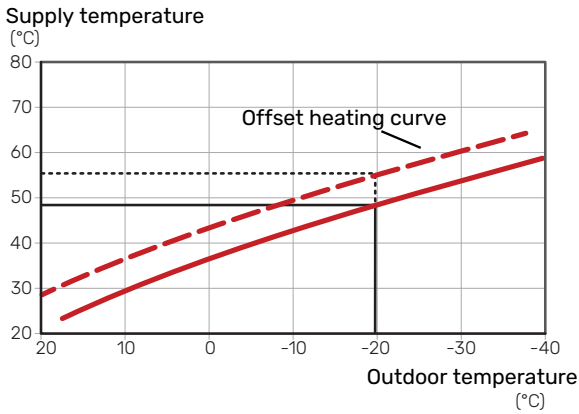

SUPPLY TEMPERATURE - MAXIMUM AND MINIMUM VALUES

Because the supply temperature cannot be calculated higher than the set maximum value or lower than the set minimum value, the curves flatten out at these temperatures.

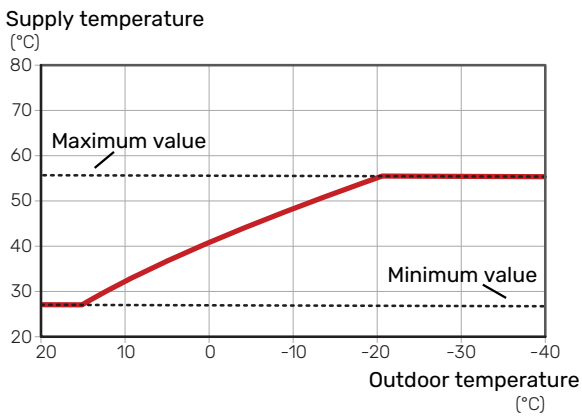

Caution

With underfloor heating systems, the maximum supply temperature is normally set between 35 and 45 °C.



Caution

Must be restricted with underfloor cooling Min. supply temp. cooling to prevent condensation.

ADJUSTMENT OF CURVE

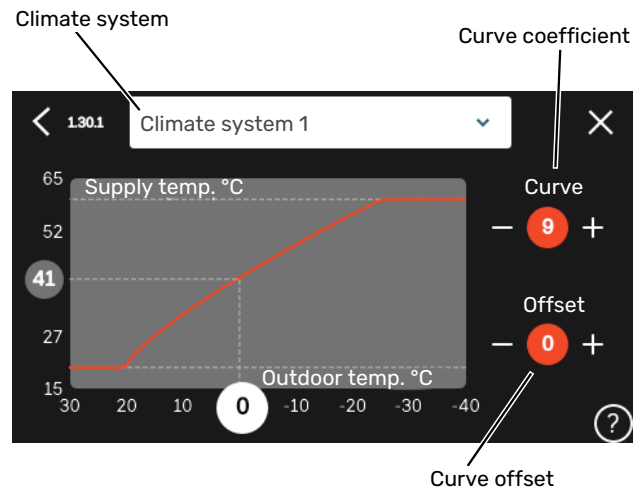

1. Select the climate system (if more than one) for which the curve is to be changed.
2. Select curve and offset.
3. Select max and min supply temperature.



Caution

Curve 0 means that "Own curve" is used. Settings for "Own curve" are made in menu 1.30.7.

TO READ OFF A HEATING CURVE

1. Drag in the circle on the axis with outdoor temperature.
2. Read off the value for supply temperature in the circle on the other axis.

BASIC VALUES FOR THE AUTOMATIC HEATING CONTROL

The values stated on the map apply to "Curve, heating" in menu 1.30.1.

- The first value applies to low temperature radiator systems¹. "Temperature" in menu 1.1 must be set to -2.
- The value in brackets refers to underfloor heating systems² installed in concrete floor structures.
- When the system is installed in a timber floor structure, you can use the number before the brackets, although this value must be reduced by two units. "Temperature" in menu 1.1 is set to -1 in these cases.



Caution

The map's values are usually a good starting point and are intended to produce a room temperature of approximately 20 °C. The values can be adjusted later, if necessary.

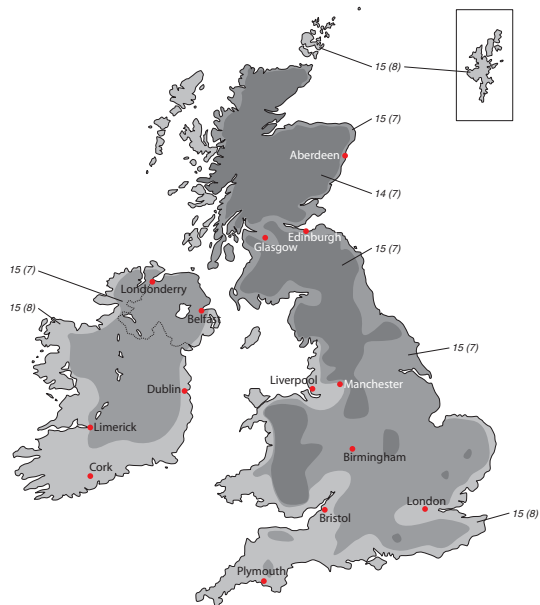

Examples of basic values selection:

- House with low temperature radiator system
London = Area 15 (8).
Set 15 in menu 1.30.1, "Curve, heating" and -2 in menu 1.1 "Temperature".
- House with underfloor heating installed in a concrete floor structure
London = Area 15 (8).
Set 8 in menu 1.30.1, "Curve, heating" and -2 in menu 1.1 "Temperature".
- House with underfloor heating installed in a timber floor structure
London = Area 15 (8).
Set 13 (see third item in the list above) in menu 1.30.1, "Curve, heating" and -1 in menu 1.1 "Temperature".



Caution

An increase in the room temperature can be slowed by the thermostats for the radiators or under floor heating. Therefore, open the thermostat valves fully, except in those rooms where a cooler temperature is required, e.g. bedrooms.

¹ A low-temperature radiator system refers to a system where the supply temperature needs to be 55 °C on the coldest day.

² Underfloor heating may be dimensioned very differently. The above example refers to a system where the supply temperature needs to be approximately 35 – 40 °C or 45 – 50 °C on the coldest day.

myUplink

With myUplink you can control the installation – where and when you want. In the event of any malfunction, you receive an alarm directly to your e-mail or a push notification to the myUplink app, which allows you to take prompt action.

Visit myuplink.com for more information.

Specification

You need the following in order for myUplink to be able to communicate with your VVM S320:

- wireless network or network cable
- Internet connection
- account on myuplink.com

We recommend our mobile apps for myUplink.

Connection

To connect your system to myUplink:

1. Select connection type (wifi/Ethernet) in menu 5.2.1 or 5.2.2.
2. In menu 5.1 you select "Request new connection string".
3. When a connection string has been produced, it is shown in this menu and is valid for 60 minutes.
4. If you do not already have an account, register in the mobile app or on myuplink.com.
5. Use the connection string to connect your installation to your user account on myUplink.

Range of services

myUplink gives you access to various levels of service. The base level is included and, apart from this, you can choose two premium services for a fixed annual fee (the fee varies depending on the functions selected).

Service level	Basic	Premium extended history	Premium change settings
Viewer	X	X	X
Alarm	X	X	X
History	X	X	X
Extended history	-	X	-
Manage	-	-	X

Control - Introduction

Display unit

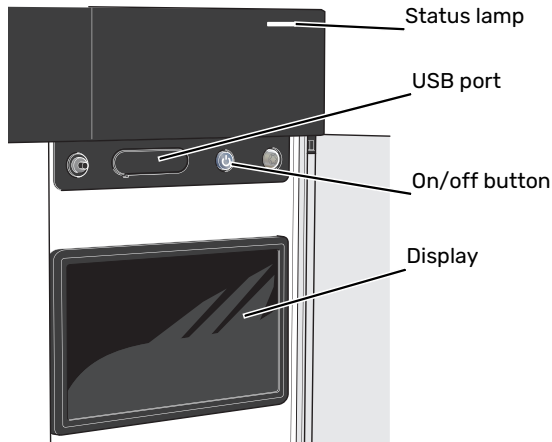

THE STATUS LAMP

The status lamp indicates current operating status. It:

- lights up white during normal operation.
- lights yellow in emergency mode.
- lights red in the event of a deployed alarm.
- flashes white during active notice.
- is blue when VVM S320 is switched off.

If the status lamp is red, you receive information and suggestions for suitable actions on the display.



TIP

You also receive this information via myUplink.

THE USB PORT

Above the display, there is a USB port that can be used e.g. for updating the software. Log into myuplink.com and click the "General" and then "Software" tab to download the latest version of the software for your installation.



TIP

If you connect the product to the network, you can update the software without using the USB port. See section "myUplink".

THE ON/OFF BUTTON

The on/off button (SF1) has three functions:

- start
- switch off
- activate emergency mode

To start: press the on/off button once.

To switch off, restart or activate emergency mode: press and hold the on/off button for 2 seconds. This brings up a menu with various options.

For hard switch off: press and hold the on/off button for 5 seconds.

To activate emergency mode when VVM S320 is switched off: press and hold the on/off button (SF1) for 5 seconds. (Deactivate the emergency mode by pressing once.)

THE DISPLAY

Instructions, settings and operational information are shown on the display.

Navigation

VVM S320 has a touchscreen where you simply navigate by pressing and dragging with your finger.

SELECT

Most options and functions are activated by lightly pressing on the display with your finger.



BROWSE

The dots at the bottom edge show that there are more pages.

Drag to the right or left with your finger to browse between the pages.

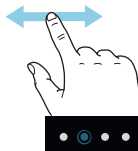

SCROLL

If the menu has several sub-menus, you can see more information by dragging up or down with your finger.



CHANGE A SETTING

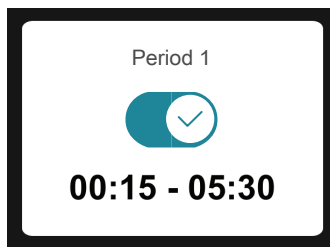

Press the setting you want to change.

If it is an on/off setting, it changes as soon as you press it.

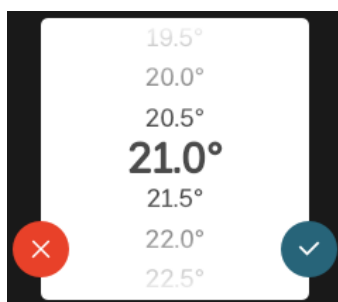

If there are several possible values, a spinning-wheel appears that you drag up or down to find the desired value.



Press  to save your change, or  if you don't want to make a change.

FACTORY SETTING

Factory set values are marked with *.

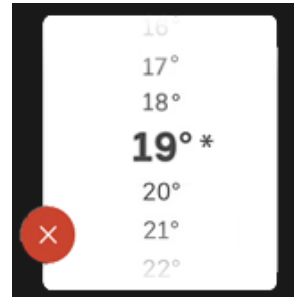

HELP MENU



In many menus there is a symbol that indicates that extra help is available.

Press the symbol to open the help text.

You may need to drag with your finger to see all text.

Menu types

HOME SCREENS

Smartguide

Smartguide helps you both to view information about the current status and to make the most common settings easily. The information that you see depends on the product you have and the accessories that are connected to the product.

Select an option and press it to proceed. The instructions on the screen help you to choose correctly or give you information about what is happening.

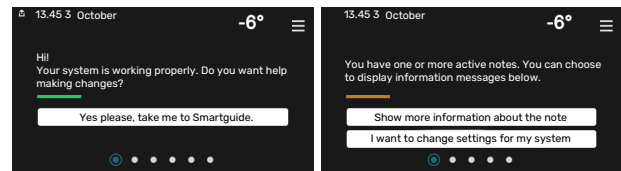

Function pages

On the function pages, you can both view information about the current status and easily make the most common settings. The function pages that you see depend on the product you have and the accessories that are connected to the product.

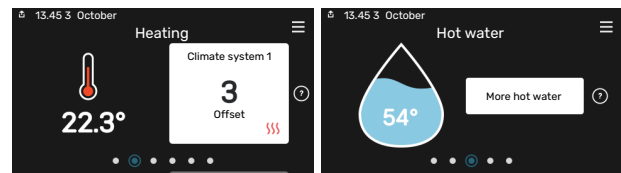

Drag to the right or left with your finger to browse between the function pages.

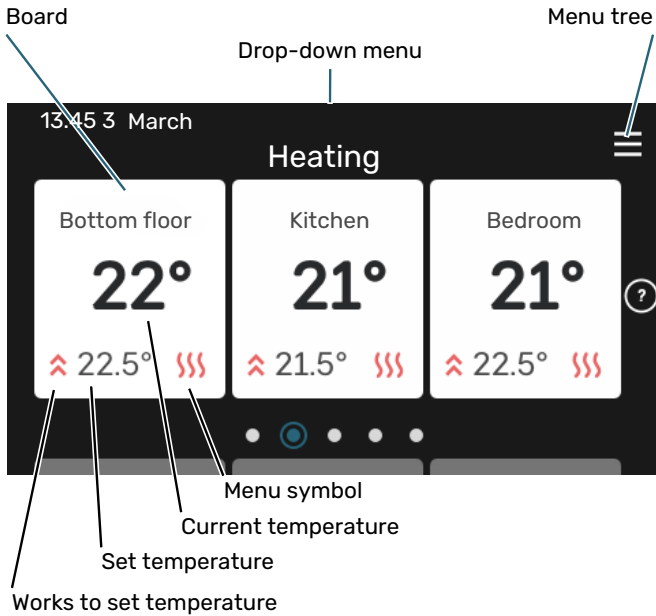

Press the card to adjust the desired value. On certain function pages, drag your finger up or down to obtain more cards.

Product overview

It can be a good idea to have the product overview open during any service cases. You can find it among the function pages.

Here, you can find information about product name, the product's serial number, the version of the software and service. When there is new software to download, you can do it here (provided that VVM S320 is connected to my-Uplink).



TIP

You enter the service details in menu 4.11.1.

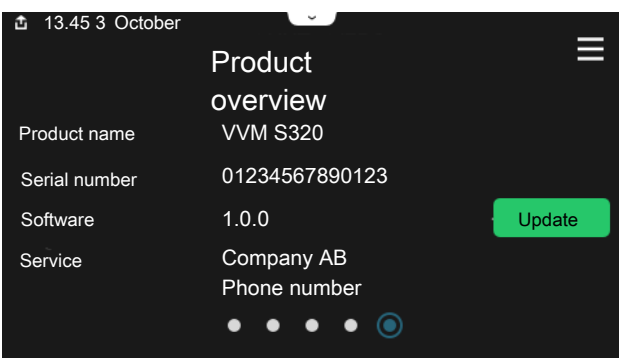

Drop-down menu

From the home screens, you reach a new window containing further information by dragging down a drop-down menu.

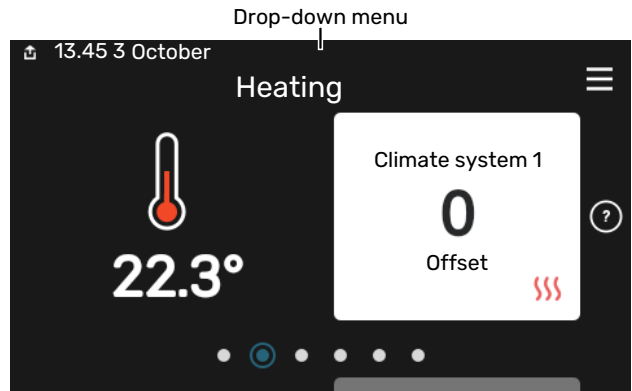

The drop-down menu shows the current status for VVM S320, what is in operation and what VVM S320 is doing at the moment. The functions that are in operation are highlighted with a frame.

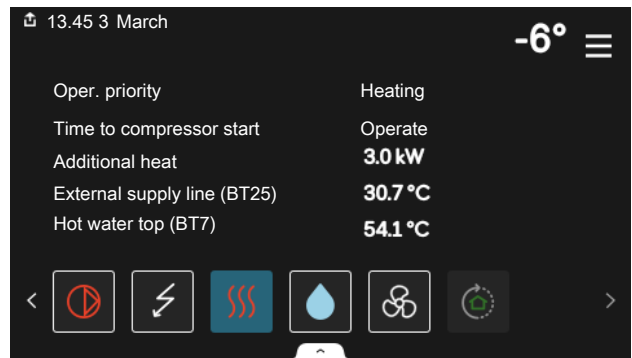

Press the icons on the menu's lower edge for more information about each function. Use the scroll bar to view all information for the selected function.

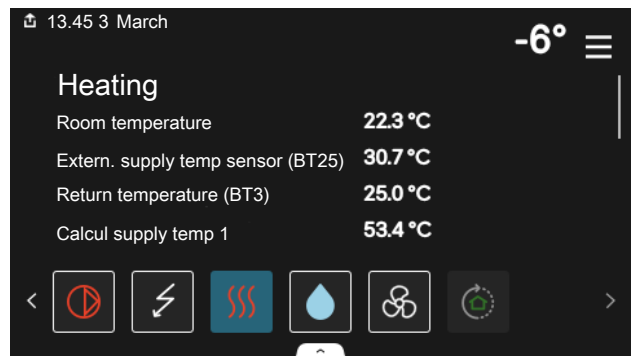

MENU TREE AND INFORMATION

In the menu tree, you can find all menus and can make more advanced settings.

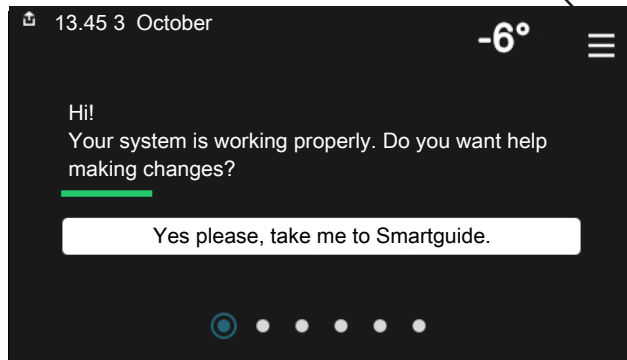

You can always press "X" to return to the home screens.

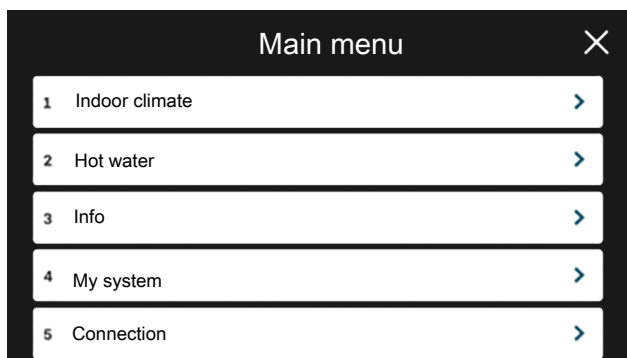

Climate systems and zones

One climate system can contain one or more zones. One zone can be a specific room. It is also possible to divide a large room into several zones, with the help of radiator thermostats.

Each zone can contain one or more accessories, e.g. room sensors or thermostats, both wired and wireless.

A zone can be set with or without the influence of the climate system's supply temperature.

OUTLINE DIAGRAM WITH TWO CLIMATE SYSTEMS AND FOUR ZONES

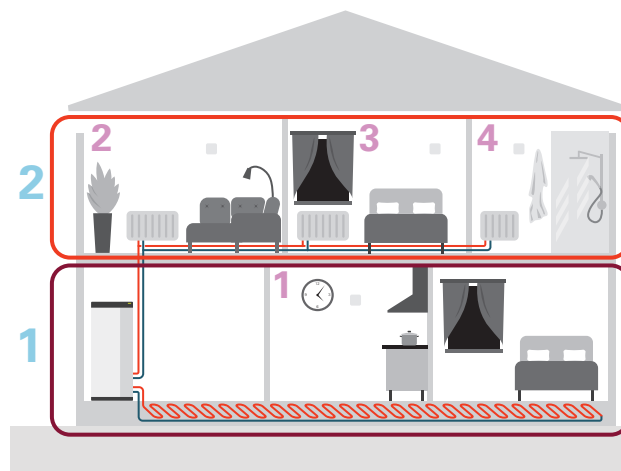

This example shows a property with two climate systems (1 and 2, two separate floors) divided into four zones (1-4, four different rooms). Temperature and demand-controlled ventilation can be controlled individually for each zone (accessory required).

Control – Menus

Menu 1 – Indoor climate

OVERVIEW

1.1 - Temperature	1.1.1 - Heating
	1.1.2 - Cooling
	1.1.3 - Humidity ¹
1.2 - Ventilation ¹	1.2.1 - Fan speed ¹
	1.2.2 - Night cooling ¹
	1.2.4 - Demand controlled ventilation ¹
	1.2.5 - Fan return time ¹
	1.2.6 - Filter cleaning interval ¹
	1.2.7 - Ventilation recovery ¹
	1.3.4 - Zones
1.3 - Room sensor settings	1.3.4 - Zones
1.4 - External influence	
1.5 - Climate system name	
1.30 - Advanced	1.30.1 - Curve, heating
	1.30.2 - Curve, cooling
	1.30.3 - External adjustment
	1.30.4 - Lowest supply heating
	1.30.5 - Lowest supply cooling
	1.30.6 - Highest supply heat
	1.30.7 - Own curve
	1.30.8 - Point offset

¹ Consult the accessory's Installer Manual.

MENU 1.1 - TEMPERATURE

Here, you make temperature settings for your installation's climate system.

If there is more than one zone and/or climate system, the settings are made for each zone/system.

MENU 1.1.1, 1.1.2 - HEATING AND COOLING

Set the temperature (with room sensor installed and activated):

Heating

Setting range: 5 – 30 °C

Cooling³

Setting range: 5 – 35°C

The value in the display appears as a temperature in °C, if the zone is controlled by a room sensor.



Caution

A slow climate system, such as underfloor heating, may be unsuitable for controlling with room sensors.

Setting the temperature (without room sensors activated):

Setting range: -10 – 10

The display shows the set value for heating/cooling (curve offset). To increase or reduce the indoor temperature, increase or reduce the value in the display.

The number of steps the value has to be changed in order to achieve a one degree change to the indoor temperature depends on the climate system. One step is usually enough, but in some cases several steps may be required.

If multiple zones in a climate system do not have activated room sensors, these will have the same curve offset.

Set the desired value. The new value is shown on the right-hand side of the symbol on home screen heating/home screen cooling.

³ Some outdoor units require cooling to be activated in menu 7.3.2.1. Accessories for the indoor unit are needed to run cooling, 4-pipe.



Caution

An increase in the room temperature can be slowed by the thermostats for the radiators or under floor heating. Therefore, open the thermostats fully, except in those rooms where a cooler temperature is required, e.g. bedrooms.



TIP

If the room temperature is constantly too low/high, you increase/decrease the value by one step in menu 1.1.1.

If the room temperature changes when the outdoor temperature changes, you increase/decrease the curve slope by one step in menu 1.30.1.

Wait 24 hours before making a new setting, so that the room temperature has time to stabilise.

MENU 1.3 - ROOM SENSOR SETTINGS

Here, you make your settings for room sensors and zones. The room sensors are grouped by zone.

Here, you select the zone to which a sensor will belong. It is possible to connect multiple room sensors to each zone. Each room sensor can be given a unique name.

The control of heating and cooling is activated by ticking the relevant option. Which options are shown depends on which type of sensor is installed. If control is not activated, the sensor will be the displaying sensor.



Caution

A slow heating system such as underfloor heating may be inappropriate for controlling with room sensors.

If there is more than one zone and/or climate system, the settings are made for each zone/system.

MENU 1.3.4 - ZONES

Here, you add and name zones. You also select the climate system to which a zone is to belong.

MENU 1.4 - EXTERNAL INFLUENCE

Information for the accessories/functions that can affect the indoor climate and that are active is shown here.

MENU 1.5 - CLIMATE SYSTEM NAME

You can give the installation's climate system a name here.

MENU 1.30 - ADVANCED

Menu "Advanced" is intended for the advanced user. This menu has several sub-menus.

"Curve, heating" Setting the heating curve slope.

"Curve, cooling" Setting the cooling curve slope.

"External adjustment" Setting the heating curve offset when the external contact is connected.

"Lowest supply heating" Setting minimum permitted supply temperature during heating operation.

"Lowest supply cooling" Setting minimum permitted supply temperature during cooling operation.

"Highest supply heat" Setting maximum permitted supply temperature for the climate system.

"Own curve" You can create your own heating curve here, if there are special requirements, by setting the desired supply temperatures for different outdoor temperatures.

"Point offset" Select a change in the heating curve at a certain outdoor temperature here. One step is usually enough to change the room temperature by one degree, but in some cases several steps may be required.

MENU 1.30.1 - CURVE, HEATING

Curve, heating

Setting range: 0 - 15

In menu "Curve, heating" you can view the heating curve for your house. The task of the heating curve is to provide an even indoor temperature, regardless of the outdoor temperature. It is from this heating curve that VVM S320 determines the temperature of the water to the climate system, the supply temperature, and therefore the indoor temperature. Here, you can select heating curve and read off how the supply temperature changes at different outdoor temperatures.



TIP

It is also possible to create your own curve. This is done in menu 1.30.7.



Caution

With underfloor heating systems, the maximum supply temperature is normally set between 35 and 45 °C.



TIP

If the room temperature is constantly too low/high, you increase/decrease the curve offset by one step.

If the room temperature changes when the outdoor temperature changes, you increase/decrease the curve slope by one step.

Wait 24 hours before making a new setting, so that the room temperature has time to stabilise.

MENU 1.30.2 - CURVE, COOLING

Curve, cooling

Setting range: 0 - 9

In the "Curve, cooling" menu you can view the cooling curve for your house. The task of the cooling curve is, together with the heating curve, to provide a uniform indoor temperature, regardless of the outdoor temperature, and thereby energy-efficient operation. It is from these curves that VVM S320 determines the temperature of the water to the heating system, the supply temperature, and consequently the indoor temperature. Here, you can select the curve and read how the supply temperature changes at different outdoor temperatures. The number to the right of "system" shows the system for which you have selected the curve.



Caution

Must be restricted with underfloor cooling Min. supply temp. cooling to prevent condensation.

Cooling in 2-pipe system

VVM S320 contains a built-in function for operating cooling in a 2-pipe system down to 17 °C. This requires that the outdoor unit can perform cooling. (See the Installer Manual for your air/water heat pump.) If the outdoor unit can perform cooling, the cooling menus are activated in the display on the indoor unit.

For operating mode "cooling" to be permitted, the average temperature must be above the set value for "start cooling" in menu 7.1.10.2 "Auto mode setting". There is the option to activate cooling by selecting "manual" operating mode in menu 4.1 "Operating mode".

The cooling settings for the climate system are adjusted in the indoor climate menu, menu 1.

MENU 1.30.3 - EXTERNAL ADJUSTMENT

External adjustment

Setting range: -10 – 10

Setting range (if room sensor is installed): 5 – 30 °C

Connecting an external switch, for example a room thermostat or a timer, allows you to raise or lower the room temperature temporarily or periodically. When the switch is on, the heating curve offset is changed by the number of steps selected in the menu. If a room sensor is installed and activated, the desired room temperature (°C) is set.

If there is more than one climate system and/or more than one zone, the setting can be made separately for each system and zone.

MENU 1.30.4 - LOWEST SUPPLY HEATING

Heating

Setting range: 5 – 80 °C

Set the minimum temperature on the supply temperature to the climate system. This means that VVM S320 never calculates a temperature lower than that set here.

If there is more than one climate system the setting can be made separately for each system.

MENU 1.30.5 - LOWEST SUPPLY COOLING

Cooling

Setting range 7 – 30 °C

Alarm, room sensor during cooling operation

Alternative: on/off

Set the minimum temperature on the supply temperature to the climate system. This means that VVM S320 never calculates a temperature lower than that set here.

If there is more than one climate system the setting can be made separately for each system.

Here, you can receive alarms during cooling operation, for example if a room sensor malfunctions.



NOTE

Cooling flow line must be set with regard to which climate system is connected. For example, floor cooling with too low cooling flow line can cause condensation precipitation, which in the worst instance could lead to moisture damage.

MENU 1.30.6 - HIGHEST SUPPLY HEAT

Climate system

Setting range: 5 – 80 °C

Here, you set the highest supply temperature for the climate system. This means that VVM S320 never calculates a temperature higher than the one set here.

If there is more than one climate system the setting can be made separately for each system. Climate systems 2 – 8 cannot be set to a higher max supply temperature than climate system 1.



Caution

With underfloor heating systems, "Maximum supply temperature for heating" should normally be set between 35 and 45°C.

MENU 1.30.7 - OWN CURVE

Own curve, heat

Supply temp

Setting range: 5 – 80 °C



Caution

Curve 0 must be selected for own curve to apply.

You can create your own heating curve here, if there are special requirements, by setting the desired supply temperatures for different outdoor temperatures.

Own curve, cooling

Supply temp

Setting range: 7 – 40 °C



Caution

Curve 0 must be selected for own curve to apply.

You can create your own cooling curve here, if there are special requirements, by setting the desired supply temperatures for different outdoor temperatures.

MENU 1.30.8 - POINT OFFSET

Outdoor temp. point

Setting range: -40 – 30 °C

Change in curve

Setting range: -10 – 10 °C

Select a change in the heating curve at a certain outdoor temperature here. One step is usually enough to change the room temperature by one degree, but in some cases several steps may be required.

The heating curve is affected at $\pm 5^\circ\text{C}$ from set outdoor temp. point.

It is important that the correct heating curve is selected so that the room temperature is experienced as even.



TIP

If it feels cold in the house at e.g. -2°C , "outdoor temp. point" is set to "-2" and "change in curve" is increased until the desired room temperature is maintained.



Caution

Wait 24 hours before making a new setting, so that the room temperature has time to stabilise.

Menu 2 – Hot water

OVERVIEW

2.1 - More hot water

2.2 - Hot water demand

2.3 - External influence

2.4 - Periodic increase

2.5 - Hot water circulation

MENU 2.1 - MORE HOT WATER

Alternatives: 3, 6, 12, 24 and 48 hours, and modes "Off" and "One-time incr."

When there is a temporary increase in hot water demand, this menu can be used to select an increase in the hot water temperature for a selectable time.

If the hot water temperature is already sufficiently high, "One-time incr." cannot be activated.

The function is activated directly when a time period is selected. The remaining time for the selected setting is shown to the right.

When the time has run out, VVM S320 returns to the set demand mode.

Select "Off" to switch off "More hot water".

MENU 2.2 - HOT WATER DEMAND

Alternatives: Small, Medium, Large, Smart control

The difference between the selectable modes is the temperature of the hot tap water. Higher temperature means that the hot water lasts longer.

Small: This mode produces less hot water at a lower temperature than the other alternatives. This mode can be used in smaller households with a small hot water demand.

Medium: Normal mode produces a larger amount of hot water and is suitable for most households.

Large: This mode produces the most hot water at a higher temperature than the other alternatives. In this mode, the immersion heater may be used to partially heat the hot water. In this mode, hot water production is prioritised ahead of heating.

Smart control: With Smart control activated, VVM S320 continuously learns the previous hot water consumption and, in this way, adjusts the temperature in the water heater for the minimum energy consumption and maximum comfort.

MENU 2.3 - EXTERNAL INFLUENCE

Information for the accessories/functions that can affect the hot water operation is shown here.

MENU 2.4 - PERIODIC INCREASE

Period

Setting range: 1 – 90 days

Start time

Setting range: 00:00 – 23:59

Next increase

The date when the next periodic increase will occur is shown here.

To prevent bacterial growth in the water heater, the heat pump and the immersion heater can increase the hot water temperature once at regular intervals.

Here, you can select the length of time between increases in the hot water temperature. The time can be set between 1 and 90 days. Tick/untick "Activated" to start/switch off the function.

MENU 2.5 - HOT WATER CIRCULATION

Operating time

Setting range: 1 – 60 min

Downtime

Setting range: 0 – 60 min

Period

Active days

Alternatives: Monday – Sunday

Start time

Setting range: 00:00 – 23:59

Stop time

Setting range: 00:00 – 23:59

Set hot water circulation for up to five periods per day here. During the set periods, the hot water circulation pump will run according to the settings above.

"Operating time" decide how long the hot water circulation pump must run per operating instance.

"Downtime" decide how long the hot water circulation pump must be stationary between operating instances.

"Period" Here, you set the period of time during which the hot water circulation pump will run, by selecting *Active days*, *Start time* and *Stop time*.



NOTE

Hot water circulation is activated in menu 7.4 "Selectable in/outputs" or via accessory.

Menu 3 - Info

OVERVIEW

3.1 - Operating info
3.2 - Temperature log
3.3 - Energy log
3.4 - Alarm log
3.5 - Product info, summary
3.6 - Licences

MENU 3.1 - OPERATING INFO

Information about the installation's current operating status (e.g. current temperatures) can be obtained here. No changes can be made.

You can also read off operating information from all your connected wireless units.

A QR code appears on one side. This QR code indicates serial number, product name and limited operating data.

MENU 3.2 - TEMPERATURE LOG

Here you can see the average temperature indoors week by week over the past year.

The average outdoor temperature is only shown if a room temperature sensor/room unit is installed.

In installations with ventilation accessories and no room sensors (BT50), the exhaust air temperature is displayed instead.

MENU 3.3 - ENERGY LOG

Number of years

Setting range: 1 - 10 years

Months

Setting range: 1 - 24 months

Here, you can see a diagram showing how much energy VVM S320 supplies and consumes. You can select which parts of the installation will be included in the log. It is also possible to activate display of indoor and/or outdoor temperature.

Number of years: Here, you select how many years will be shown in the diagram.

Months: Here, you select how many months will be shown in the diagram.

MENU 3.4 - ALARM LOG

To facilitate troubleshooting, the installation's operating status at the time of an alarm is stored here. You can see information for the 10 most recent alarms.

To view operating status in the event of an alarm, select the relevant alarm from the list.

MENU 3.5 - PRODUCT INFO, SUMMARY

Here, you can see general information about your system, such as software versions.

MENU 3.6 - LICENCES

You can view licences for open source code here.

Menu 4 - My system

OVERVIEW

4.1 - Operating mode	
4.2 - Plus functions	4.2.2 - Solar electricity ¹
	4.2.3 - SG Ready
	4.2.5 - Smart Price Adaption™
4.3 - Profiles ¹	
4.4 - Weather control	
4.5 - Away mode	
4.6 - Smart Energy Source™	
4.7 - Energy price	4.7.1 - Variable electricity price
	4.7.3 - Shunt-controlled additional heat ¹
	4.7.4 - Step-controlled additional heat ¹
	4.7.6 - External additional heat ¹
4.8 - Time and date	
4.9 - Language	
4.10 - Country	
4.11 - Tools	4.11.1 - Installer details
	4.11.2 - Sound when pressing button
	4.11.3 - Fan de-icing ¹
	4.11.4 - Home screen
4.30 - Advanced	4.30.4 - Fact. settings user

¹ Consult the accessory's Installer Manual.

MENU 4.1 - OPERATING MODE

Operating mode

Alternative: Auto, Manual, Add. heat only

Manual

Alternative: Compressor, Add. heat, Heating, Cooling

Add. heat only

Alternative: Heating

The operating mode for VVM S320 is normally set to "Auto". It is also possible to select operating mode "Add. heat only". Select "Manual" to choose that functions will be activated.

If "Manual" or "Add. heat only" is selected, selectable options are shown further down. Tick the functions you want to activate.

Operating mode "Auto"

In this operating mode, VVM S320 automatically selects which functions are permitted.

Operating mode "Manual"

In this operating mode you can select what functions are permitted.

"Compressor" is the unit that produces hot water, heating and cooling for the home. You cannot deselect "compressor" in manual mode.

"Add. heat" is the unit that helps the compressor to heat the home and/or the hot water when it cannot manage the entire requirement alone.

"Heating" means you obtain heating in the home. You can deselect the function when you do not wish to have the heating on.

"Cooling" means that you obtain cooling in the home in hot weather. You can deselect this function when you do not wish to have the cooling running.



Caution

If you deselect "Add. heat" it may mean that insufficient hot water and/or heating in the accommodation is achieved.

Operating mode "Add. heat only"

In this operating mode the compressor is not active, only additional heat is used.



Caution

If you choose mode "Add. heat only" the compressor is deselected and there is a higher operating cost.



Caution

You should not change from only additional heat, if you do not have a heat pump connected (see menu 7.3.1 - "Configure").

MENU 4.2 - PLUS FUNCTIONS

Settings for any additional functions installed in VVM S320 can be made in the sub menus.

MENU 4.2.3 - SG READY

Here, you set the part of your climate system (e.g. room temperature) that will be affected on activation of "SG Ready". The function can only be used in mains networks that support the "SG Ready" standard.

Affect room temperature

With low price mode on "SG Ready", the parallel offset for the indoor temperature is increased by "+1". If a room sensor is installed and activated, the desired room temperature is increased instead by 1 °C.

With overcapacity mode on "SG Ready", the parallel offset for the indoor temperature is increased by "+2". If a room sensor is installed and activated, the desired room temperature is increased by 2 °C instead.

Affect hot water

With low price mode on "SG Ready", the stop temperature for the hot water is set as high as possible with compressor operation only (immersion heater not permitted).

In the case of overcapacity mode on "SG Ready", the hot water is set to large demand mode (immersion heater permitted).

Affect cooling

With low price mode of "SG Ready" and cooling operation the indoor temperature is not affected.

With overcapacity mode on "SG Ready" and cooling operation, the parallel offset for the indoor temperature is decreased by "-1". If a room sensor is installed and activated, the desired room temperature is decreased by 1 °C instead.



NOTE

The function must be connected to two AUX inputs and be activated in menu 7.4 "Selectable in/outputs".

MENU 4.2.5 - SMART PRICE ADAPTION™

Range

Alternative: on/off

Affect room temp heating

Alternative: on/off

Degree of effect

Setting range: 1 – 10

Affect hot water

Alternative: on/off

Degree of effect

Setting range: 1 – 4

Deactivate Smart control (HW)

Alternative: on/off⁴

Affect cooling

Alternative: on/off

Degree of effect

Setting range: 1 – 10

This function can only be used if your electricity supplier supports Smart price adaption™, if you have an hourly tariff agreement and an active myUplink account.

Smart price adaption™ adjusts some of the installation's consumption during the day to those periods with the cheapest electricity tariff, which can provide savings if you are on an hourly rate based electricity contract. The function is based on downloading hourly rates for the next day via myUplink, and for this reason an Internet connection and an account for myUplink are required.

Range: Contact your electricity supplier for information about which area (zone) the installation belongs to.

Degree of effect: You can choose which parts of the installation will be affected by the electricity price and to what extent; the higher value you select, the greater the effect the electricity price has.



NOTE

A value that is set high may result in increased savings, but may also affect the comfort.

MENU 4.4 - WEATHER CONTROL

Activate weath. contr.

Alternative: on/off

Factor

Setting range: 0 – 10

You can select whether you want VVM S320 to adjust the indoor climate based on the weather forecast here.

You can set factor for outdoor temperature. The higher the value, the greater the effect from the weather forecast.

⁴ See menu 2.2 for more information about Smart Control.



Caution

This menu is only visible if the installation is connected to myUplink.

MENU 4.5 - AWAY MODE

In this menu, you activate/deactivate "Away mode".

When away mode is activated, the following functions are affected:

- the setting for heating is lowered slightly
- the setting for cooling is raised slightly
- the hot water temperature is lowered if demand mode "large" or "medium" is selected
- The AUX function "Away mode" is activated.

If you want, you can select for the following functions to be affected:

- ventilation (accessory is required)
- hot water circulation (accessory or use of AUX is required)

MENU 4.6 - SMART ENERGY SOURCE™



NOTE

Smart Energy Source™ requires external additional heat.

Smart Energy Source™

Alternative: on/off

Control method

Setting options: Price per kWh / CO2

If Smart Energy Source™ is activated, VVM S320 prioritises how/to what extent each docked energy source will be used. Here, you can select whether the system will use the energy source that is cheapest at the time or the one that is most carbon dioxide neutral at the time.



Caution

Your choices in this menu affect menu 4.7 - "Energy price".

MENU 4.7 - ENERGY PRICE

Here you can use tariff control for your additional heat.

Here you can choose whether the system is to exercise control based on the spot price, tariff control or a set price. The setting is made for each individual energy source. Spot price can only be used if you have an hourly tariff agreement with your electricity supplier.

Set the lower tariff periods. It is possible to set two different date periods per year. Within these periods, it is possible to set up to four different periods on weekdays (Monday to Friday) or four different periods on weekends (Saturdays and Sundays).



Caution

This menu is only visible if Smart Energy Source is activated.

MENU 4.7.1 - VARIABLE ELECTRICITY PRICE

Here you can use tariff control for the electric additional heat.

Set the lower tariff periods. It is possible to set two different date periods per year. Within these periods, it is possible to set up to four different periods on weekdays (Monday to Friday) or four different periods on weekends (Saturdays and Sundays).

MENU 4.8 - TIME AND DATE

Set time and date, display mode and time zone here.



TIP

Time and date are set automatically if connected to myUplink. To obtain the correct time, the time zone must be set.

MENU 4.9 - LANGUAGE

Choose the language that you want the information to be displayed in here.

MENU 4.10 - COUNTRY

Here, you specify the country in which the product has been installed. This allows access to country-specific settings in your product.

Language settings can be made regardless of this selection.



NOTE

This option locks after 24 hours, restart of display or program updating. Afterwards, it is not possible to change the country selected in this menu without first replacing components in the product.

MENU 4.11 - TOOLS

Here, you can find tools for use.

MENU 4.11.1 - INSTALLER DETAILS

The installer's name and telephone number are entered in this menu.

Afterwards, the details are visible in the home screen, "Product overview".

MENU 4.11.2 - SOUND WHEN PRESSING BUTTON

Alternative: on/off

Here you choose if you want to hear a sound when you press buttons on the display.

MENU 4.11.4 - HOME SCREEN

Alternative: on/off

Here, you choose which home screens you want to be displayed.

The number of options in this menu varies depending on which products and accessories are installed.

MENU 4.30 - ADVANCED

Menu "Advanced" is intended for advanced users.

MENU 4.30.4 - FACT. SETTINGS USER

All settings that are available to the user (including advanced menus) can be reset to default values here.



Caution

After the factory setting, personal settings such as the heating curve must be reset.

Menu 5 - Connection

OVERVIEW

5.1 - myUplink	
5.2 - Network settings	5.2.1 - wifi
	5.2.2 - Ethernet
5.4 - Wireless units	
5.10 - Tools	5.10.1 - Direct connection

MENU 5.1 - MYUPLINK

Here, you obtain information about the installation's connection status, serial number and how many users and service partners are connected to the installation. A connected user has a user account in myUplink, which has been given permission to control and/or monitor your installation.

You can also manage the installation's connection to myUplink and request a new connection string.

It is possible to switch off all users and service partners who are connected to the installation via myUplink.



NOTE

After disconnecting all users none of them can monitor or control your installation via myUplink without requesting a new connection string.

MENU 5.2 - NETWORK SETTINGS

Here, you choose whether your system connects to the Internet via wifi (menu 5.2.1) or via a network cable (Ethernet) (menu 5.2.2).

Here, you can set TCP/IP settings for your installation.

To set the TCP/IP settings with the aid of DHCP, activate "Automatic".

During manual setting, select "IP address" and enter the correct address using the keyboard. Repeat the procedure for "Network mask", "Gateway" and "DNS".



Caution

The installation cannot connect to the Internet without the correct TCP/IP settings. If you are unsure about applicable settings, use the "Automatic" mode or contact your network administrator (or equivalent) for further information.



TIP

All settings made since opening the menu can be reset by selecting "Reset".

MENU 5.4 - WIRELESS UNITS

In this menu you connect wireless units, and manage settings for connected units.

Add the wireless unit by pressing "Add unit". For the quickest identification of a wireless unit, it is recommended that you put your master unit in search mode first. Then put the wireless unit in identification mode.

MENU 5.10 - TOOLS

As the installer, you can e.g. connect an installation via an app here, by activating an access point for direct connection to a mobile phone.

MENU 5.10.1 - DIRECT CONNECTION

You can activate direct connection via Wi-Fi here. This means that the installation will lose communication with the relevant network, and that you instead make settings on your mobile unit that you connect to the installation.

Menu 6 - Scheduling

OVERVIEW

6.1 - Holiday

6.2 - Scheduling

MENU 6.1 - HOLIDAY

In this menu, you schedule longer changes in heating and hot water temperature.

You can also schedule settings for certain installed accessories.

If a room sensor is installed and activated, the desired room temperature (°C) is set during the time period.

If a room sensor is not activated, the desired offset of the heating curve is set. One step is usually enough to change the room temperature by one degree, but in some cases several steps may be required.



TIP

Stop the holiday setting about a day before your return so that room temperature and hot water have time to return to their usual levels.



Caution

Holiday settings finish on the selected date. If you want to repeat the holiday setting once the end date has passed, go into the menu and change the date.

MENU 6.2 - SCHEDULING

In this menu, you schedule repeated changes of heating and hot water, for example.

You can also schedule settings for certain installed accessories.



Caution

A schedule repeats according to the selected setting (e.g. every Monday) until you go into the menu and switch it off.

A mode contains settings that will apply to scheduling. Create a mode with one or more settings by pressing "New mode".

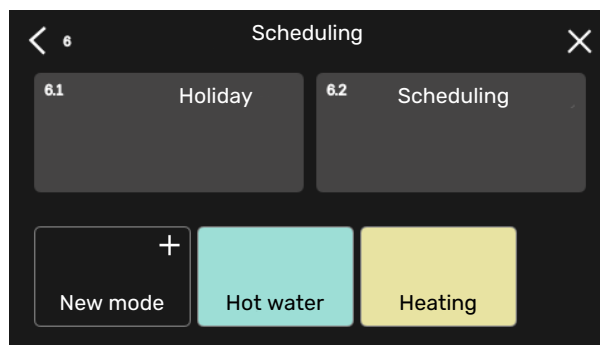

Select the settings that the mode will contain. Drag to the left with your finger to select mode name and colour to make it unique and to distinguish it from other modes.

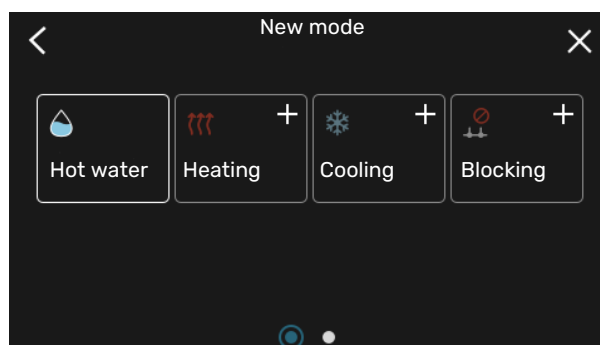

Select an empty row and press it to schedule a mode, and adjust as required. You can enter a tick, if a mode is to be active during the day or overnight.

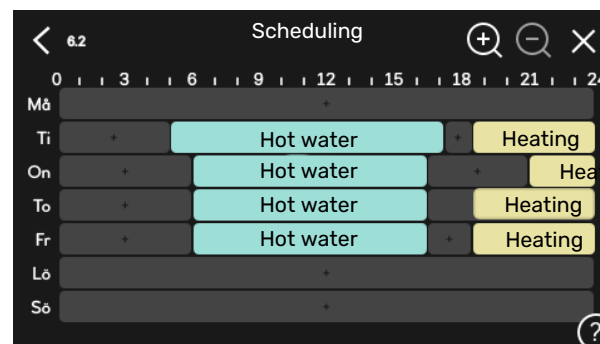

If a room sensor is installed and activated, the desired room temperature (°C) is set during the time period.

If a room sensor is not activated, the desired offset of the heating curve is set. One step is usually enough to change the room temperature by one degree, but in some cases several steps may be required.

Menu 7 - Service

OVERVIEW

7.1 - Operating settings	7.1.1 - Hot water	7.1.1.1 - Temperature setting
	7.1.2 - Circulation pumps	7.1.2.1 - Op. mode HM pump GP1
		7.1.2.2 - Pp sp. heating medium GP1
	7.1.4 - Ventilation ¹	7.1.4.1 - Fan speed, exhaust air ¹
		7.1.4.2 - Fan speed, supply air ¹
		7.1.4.3 - Fine-tuning the ventilation ¹
		7.1.4.4 - Demand contr. ventilation ¹
	7.1.5 - Add. heat	7.1.5.1 - Int elec add heat
	7.1.6 - Heating	7.1.6.1 - Max diff supply temp
		7.1.6.2 - Flow settings, climate sys
		7.1.6.3 - Power at DOT
	7.1.7 - Cooling ¹	7.1.7.1 - Cooling settings ¹
		7.1.7.2 - Humidity control ¹
		7.1.7.3 - System settings cooling ¹
	7.1.8 - Alarms	7.1.8.1 - Alarm actions
		7.1.8.2 - Emergency mode
	7.1.9 - Load monitor	
	7.1.10 - System settings	7.1.10.1 - Operating prioritisation
		7.1.10.2 - Auto mode setting
		7.1.10.3 - Degree minute settings
7.2 - Accessory settings ¹	7.2.1 - Add/remove accessories	
	7.2.19 - External energy meter	
7.3 - Multi-installation	7.3.1 - Configure	
	7.3.2 - Installed heat pump	
	7.3.3 - Name heat pump	
	7.3.5 - Serial number	
7.4 - Selectable in/outputs		
7.5 - Tools	7.5.1 - Heat pump, test	7.5.1.1 - Test mode
	7.5.2 - Underfloor drying function	
	7.5.3 - Forced control	
	7.5.8 - Screen lock	
	7.5.9 - Modbus TCP/IP	
	7.5.10 - Change pump model	
7.6 - Factory setting service		
7.7 - Start guide		
7.8 - Quick start		
7.9 - Logs	7.9.1 - Change log	
	7.9.2 - Extended alarm log	
	7.9.3 - Black box	

¹ Consult the accessory's Installer Manual.

MENU 7.1 - OPERATING SETTINGS

Make operating settings for the system here.

MENU 7.1.1 - HOT WATER

This menu contains advanced settings for hot water operation.

MENU 7.1.1.1 - TEMPERATURE SETTING

Start temperature

Demand mode, small/medium/large

Setting range: 5 – 70 °C

Stop temperature

Demand mode, small/medium/large

Setting range: 5 – 70 °C

Stop temp. periodic increase

Setting range: 55 – 70 °C

Start temp. and stop temp. demand mode, small/medium/large: Here, you set the start and stop temperature of the hot water for the different demand modes (menu 2.2).

Stop temp. periodic increase: Here, you set the stop temperature for periodic increase (menu 2.4).

MENU 7.1.2 - CIRCULATION PUMPS

This menu contains sub-menus where you can make advanced circulation pump settings.

MENU 7.1.2.1 - OP. MODE HM PUMP GP1

Operating mode

Options: Auto, Intermittent

Auto: The heating medium pump runs according to the current operating mode for VVM S320.

Intermittent: The heating medium pump starts approx. 20 seconds before and stops 20 seconds after the compressor.

MENU 7.1.2.2 - PP SP. HEATING MEDIUM GP1

Heating

Auto

Alternative: on/off

Manual speed

Setting range: 1 - 100 %

Minimum permitted speed

Setting range: 1 - 50 %

Maximum permitted speed

Setting range: 80 - 100 %

Speed in wait mode

Setting range: 1 - 100 %

Hot water

Auto

Alternative: on/off

Manual speed

Setting range: 1 - 100 %

Cooling

Speed during active cooling

Setting range: 1 - 100 %

Auto

Alternative: on/off

Manual speed

Setting range: 1 - 100 %

Pool

Auto

Alternative: on/off

Manual speed

Setting range: 1 - 100 %

Make settings here for the heating medium pump's speed in the current operating mode, for example in heating or hot water operation. Which operating modes can be changed depends on which accessories are connected.

Heating

Auto: Here, you set whether the heating medium pump is to be regulated automatically or manually.

Manual speed: If you have opted to control the heating medium pump manually, you set the desired pump speed here.

Minimum permitted speed: Here, you can restrict the pump speed to ensure that the heating medium pump is not allowed to operate at a lower speed in auto mode than the set value.

Maximum permitted speed: Here, you can restrict the pump speed to ensure that the heating medium pump is not allowed to operate at a higher speed than the set value.

Speed in wait mode: Here, you set the speed the heating medium pump will have in standby mode. Standby mode occurs when heating or cooling operation is permitted but there is no need for either compressor operation or electric additional heat.

Hot water

Auto: Here, you set whether the heating medium pump is to be regulated automatically or manually in hot water mode.

Manual speed: If you have opted to control the heating medium pumps manually, you set the desired pump speed here in hot water mode.

Cooling

Speed during active cooling: Here, you set the desired pump speed for active cooling.

Auto: Here, you set whether the heating medium pump is to be regulated automatically or manually.

Manual speed: If you have opted to control the heating medium pump manually, you set the desired pump speed here.

Pool

Auto: Here, you set whether the heating medium pump is to be regulated automatically or manually during pool charging.

Manual speed: If you have opted to control the heating medium pumps manually, you set the desired pump speed here during pool charging.

MENU 7.1.5 - ADD. HEAT

This menu contains sub-menus where you can make advanced additional heat settings.

MENU 7.1.5.1 - INT ELEC ADD HEAT

Max. set electrical power

Setting range 1x230 V: 0 – 7 kW

Max set el power (SG Ready)

Setting range 1x230V: 0 – 7 kW

Here you set the max electrical power for the internal electric additional heat in VVM S320, during normal operation and in overcapacity mode (SG Ready).

If electric additional heating has been switched from 7 kW to 9 kW, this is set in "Max. connected el. power".

MENU 7.1.6 - HEATING

This menu contains sub-menus where you can make advanced settings for heating operation.

MENU 7.1.6.1 - MAX DIFF SUPPLY TEMP

Max diff compressor

Setting range: 1 – 25 °C

Max diff additional heat

Setting range: 1 – 24 °C

BT12 offset heat pump 1

Setting range: -5 – 5 °C

Here you set the maximum permitted difference between the calculated and actual supply temperature in the event of compressor or additional heat mode respectively. Max difference additional heat can never exceed max difference compressor

Max diff compressor: If the current supply temperature exceeds the calculated supply line by the set value, the degree minute value is set to 1. The compressor stops when there is only a heating demand.

Max diff additional heat: If "Additional heat" is selected and activated in menu 4.1 and the current supply temperature exceeds the calculated temperature by the set value, the additional heat is forced to stop.

BT12 offset: If there is a difference between external supply temperature sensor (BT25) and condenser sensor, supply (BT12), you can set a fixed offset here to compensate for the difference.

MENU 7.1.6.2 - FLOW SETTINGS, CLIMATE SYS

Setting

Options: Radiator, Underfl heating, Rad + Und. heat., Own setting

DOT

Setting range DOT: -40.0 – 20.0 °C

Delta temp at DOT

Setting range dT at DOT: 1.0 – 25.0 °C

The type of heating distribution system the heating medium pump works towards is set here.

dT at DOT is the difference in degrees between supply and return temperatures at design outdoor temperature.

MENU 7.1.6.3 - POWER AT DOT

Manually selected power at DOT

Alternative: on/off

Power at DOT

Setting range: 1 – 1,000 kW

Here, you set the power the property requires at DOT (dimensioned outdoor temperature).

If you choose not to activate "Manually selected power at DOT", the setting is made automatically, i.e. VVM S320 calculates suitable power at DOT.

MENU 7.1.8 - ALARMS

In this menu, you make settings for the safety measures that VVM S320 will implement in the event of any operational disruption.

MENU 7.1.8.1 - ALARM ACTIONS

Reduce room temperature

Alternative: on/off

Stop producing HW

Alternative: on/off

Audio signal on alarm

Alternative: on/off

Select how you want the VVM S320 to alert you that there is an alarm in the display here.

The different alternatives are that VVM S320 stops producing hot water and/or reduces the room temperature.



Caution

If no alarm action is selected, this can result in higher energy consumption in the event of a malfunction.

MENU 7.1.8.2 - EMERGENCY MODE

Immersion heater output

Setting range: 4 – 7 kW

Settings are made in this menu for how the additional heat will be controlled in emergency mode.



Caution

In emergency mode, the display is switched off. If you feel the selected settings are insufficient in emergency mode, you will not be able to change these.

MENU 7.1.9 - LOAD MONITOR

Fuse size

Setting range: 1 – 400 A

Transformer ratio

Setting range: 300 – 3,000

Here, you set fuse size and transformer ratio for the system. The transformer ratio is the factor that is used to convert the metered voltage to current.

MENU 7.1.10 - SYSTEM SETTINGS

You make your various system settings for your installation here.

MENU 7.1.10.1 - OPERATING PRIORITISATION

Auto mode

Alternative: on/off

Min

Setting range: 0 – 180 minutes

Here, you select how long the installation will work with each demand, if there are several simultaneous demands.

"Operating prioritisation" is normally set in "Auto", but it is also possible to set prioritisation manually.

Auto: In auto mode, VVM S320 optimises operating times between different requirements.

Manual: You select how long the installation will work with each demand, if there are several demands at the same time.

If there is only one demand, the installation works with that demand.

If 0 minutes are selected, this means that the demand is not prioritised, but will instead only be activated when there is no other demand.

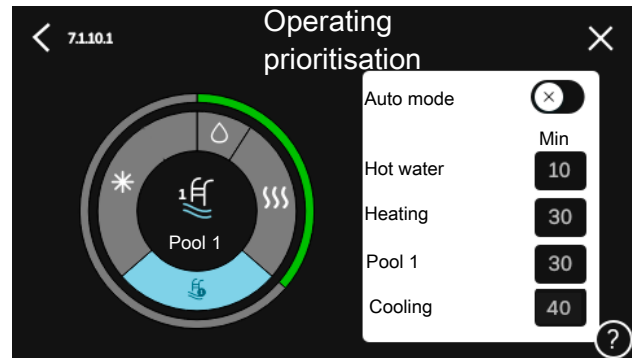

MENU 7.1.10.2 - AUTO MODE SETTING

Start cooling

Setting range: 15 – 40 °C

Setting range, cooling, 4-pipe: 15 – 40°C

Stop heating

Setting range: -20 – 40 °C

Stop additional heat

Setting range: -25 – 40 °C

Filtering time heating

Setting range: 0 – 48 h

Filtering time, cooling

Setting range: 0 – 48 h

Time betw. cooling and heating

Setting range: 0 – 48 h

Cooling/heat sensor

Setting range: None, BT74, Zone 1 - x

Set point value cool/heat sensor

Setting range: 5 – 40 °C

Heating at subnormal room temp

Setting range: 0.5 – 10.0 °C

Cooling at excess room temp

Setting range: 0.5 – 10.0 °C

Stop heating, Stop additional heat: In this menu, you set the temperatures that the system will use for control in auto mode.

Filtering time: You can set the time over which the average outdoor temperature is calculated. If you select 0, the current outdoor temperature is used.

Time betw. cooling and heating: Here, you can set how long VVM S320 will wait before it returns to heating mode when the cooling demand has ceased or vice versa.

Cooling/heat sensor

Here, you select the sensor that will be used for cooling/heating. If BT74 is installed, it will be preselected and no other option is possible.

Set point value cool/heat sensor: Here, you can set the indoor temperature at which VVM S320 will shift between heating and cooling operation.

Heating at subnormal room temp: Here, you can set how far the room temperature may drop below the desired temperature before VVM S320 switches to heating operation.

Cooling at excess room temp: Here, you can set how high the room temperature may increase above the desired temperature before VVM S320 switches to cooling operation.

MENU 7.1.10.3 - DEGREE MINUTE SETTINGS

Current value

Setting range: -3,000 – 3,000 DM

Heating, auto

Alternative: on/off

Start compressor

Setting range: -1,000 – (-30) DM

Relative DM start additional heat

Setting range: 100 – 2,000 DM

Diff. between add heat steps

Setting range: 10 – 1,000 DM

Cooling, auto

Alternative: on/off

Degree minutes cooling

Alternatives: -3,000 – 3,000 DM

Start active cooling

Alternatives: 10 – 300 DM

DM = degree minutes

Degree Minutes (DM) are a measurement of the current heating/cooling demand in the house and determine when the compressor or additional heat will start/stop.



Caution

Higher value on "Start compressor" gives more compressor starts, which increase wear on the compressor. Too low value can give uneven indoor temperatures.

Start active cooling: Here, you set when active cooling will start.

MENU 7.2 - ACCESSORY SETTINGS

The operating settings for accessories that are installed and activated are made in the sub-menus for this.

MENU 7.2.1 - ADD/REMOVE ACCESSORIES

Here, you tell VVM S320 which accessories are installed.

To identify connected accessories automatically, select "Search for accessories". It is also possible to select accessories manually from the list.

MENU 7.2.19 - PULSE ENERGY METER

Activated

Alternative: on/off

Set mode

Alternatives: Energy per pulse / Pulses per kWh

Energy per pulse

Setting range: 0 – 10000 Wh

Pulses per kWh

Setting range: 1 – 10000

Up to two electricity meters or energy meters (BE6-BE7) can be connected to VVM S320.

Energy per pulse: Here you set the amount of energy to which each pulse will correspond.

Pulses per kWh: Here, you set the number of pulses per kWh that are sent to VVM S320.



TIP

"Pulses per kWh" is set and presented in whole numbers. If a higher resolution is required, use "Energy per pulse".

MENU 7.3 - MULTI-INSTALLATION

You make settings for the heat pump that is connected to VVM S320 in the sub-menus.

MENU 7.3.1 - CONFIGURE

Search installed heat pumps: Here, you can search for, activate or deactivate the connected heat pump.

MENU 7.3.2 - INSTALLED HEAT PUMP

Here, you make settings that are specific for the installed heat pump. To see what settings you can make, see the Installer Manual for the heat pump.

MENU 7.3.3 - NAME HEAT PUMP

Here, you name the heat pump that is connected to VVM S320.

MENU 7.3.5 - SERIAL NUMBER

Here you allocate the installation's air/water heat pump a serial number, e.g. after replacing the circuit board.



Caution

This menu is only shown if the connected heat pump does not have a serial number. (This may be the case during service visits.)

MENU 7.4 - SELECTABLE IN/OUTPUTS

Here, you state where the external switch function has been connected, either to one of the AUX inputs on terminal block X28 or to the AUX output on terminal block X27.

MENU 7.5 - TOOLS

Here, you can find functions for maintenance and service work.

MENU 7.5.1 - HEAT PUMP, TEST



NOTE

This menu and its sub-menus are intended for testing the heat pump.

Use of this menu for other reasons may result in your installation not functioning as intended.

MENU 7.5.2 - UNDERFLOOR DRYING FUNCTION

Length period 1 - 7

Setting range: 0 - 30 days

Temperature period 1 - 7

Setting range: 15 - 70 °C

Set the function for under floor drying here.

You can set up to seven time periods with different calculated supply temperatures. If fewer than seven periods are to be used, set the remaining periods to 0 days.

When the underfloor drying function has been activated, a counter is displayed showing the number of full days the function has been active. The function counts degree minutes in the same way as during normal heating operation, but for the supply temperatures that are set for the respective period.



TIP

If the operating mode "Additional heat only" is to be used, select it in menu 4.1.

For a more even supply temperature, the additional heat can be started earlier by setting "relative DM start additional heat" in menu 7.1.10.3 to -80. When set underfloor drying periods have finished, reset the menus 4.1 and 7.1.10.3 as per previous settings.

MENU 7.5.3 - FORCED CONTROL

Here you can force control the various components in the installation. The most important safety functions remain active however.



NOTE

Forced control is only intended to be used for troubleshooting purposes. Using the function in any other way may cause damage to the components in your installation.

MENU 7.5.8 - SCREEN LOCK

Here, you can choose to activate the screen lock for VVM S320. During activation, you will be asked to enter the required code (four digits). The code is used when:

- deactivating the screen lock.
- changing the code.
- starting up the display when it has been inactive.

- restarting/starting up VVM S320.

MENU 7.5.9 - MODBUS TCP/IP

Alternative: on/off

Here, you activate Modbus TCP/IP. Read more on page 62.

MENU 7.5.10 - CHANGE PUMP MODEL

Here, you select the model of circulation pump that is connected to the installation.

MENU 7.6 - FACTORY SETTING SERVICE

Here, you can reset all settings (including settings available to the user) to factory values

You can also choose to reset the connected heat pump to the factory settings here.



NOTE

When resetting, the start guide is displayed the next time VVM S320 restarts.

MENU 7.7 - START GUIDE

When VVM S320 is started for the first time, the start guide is automatically activated. From this menu, you can start it manually.

MENU 7.8 - QUICK START

You can quick start the compressor here.

One of the following demands for the compressor must exist for quick start:

- heating
- hot water
- cooling
- pool (accessory is required)



Caution

Too many quick starts in a short space of time may damage the compressor and its auxiliary equipment.

MENU 7.9 - LOGS

Under this menu, there are logs that collect information about alarms and changes made. The menu is intended to be used for troubleshooting.

MENU 7.9.1 - CHANGE LOG

Read off any previous changes to the control system here.



NOTE

The change log is saved at restart and remains unchanged after factory setting.

MENU 7.9.2 - EXTENDED ALARM LOG

This log is intended to be used for troubleshooting.

MENU 7.9.3 - BLACK BOX

Via this menu, it is possible to export all logs (Change log, Extended alarm log) to USB. Connect a USB memory and select the log(s) you want to export.

Service

Service actions



NOTE

Servicing should only be carried out by persons with the necessary expertise.

When replacing components on VVM S320 only replacement parts from NIBE may be used.



NOTE

If an electrical connection has been disconnected and is connected, ground must be checked using a suitable multimeter.



NOTE

An immersion heater without a temperature limiter is not allowed to be installed.



NOTE

After servicing, complete the relevant Service Interval Record section of the Benchmark Checklist located at the back of this document.

Completion of the Service Interval Record is a condition of warranty. For full terms and conditions of warranty, please see our website nibe.co.uk.

MAINTENANCE

General inspection

Check the following:

1. Condition of casing.
2. Electrical connections.
3. Pipe connections.
4. Alarm log.

Correct any fault before continuing.

Water heater

Check the following:

1. Hot water start and stop temperature.
2. Pressure controlled bypass valve.
3. T&P valve.
4. Overflow pipe.
5. Pressure expansion vessel.

Correct any fault before continuing.

Climate system

Check the following:

1. Climate system start and stop temperature.
2. Heating curve settings.
3. Function of the room sensor (if installed).
4. System pressure.
5. Flow and return temperature. The difference must be 5 - 10 °C.

Correct any fault before continuing.

EMERGENCY MODE



NOTE

Do not start the system before filling up with water. Components in the system could be damaged.

Emergency mode is used in event of operational interference and in conjunction with service.

When the emergency mode is active, the status lamp is yellow.

You can activate the emergency mode both when VVM S320 is running and when it is switched off.

To activate when VVM S320 is running: press and hold the on/off button (SF1) for 2 seconds and select "emergency mode" from the shutdown menu.

To activate emergency mode when VVM S320 is switched off: press and hold the on/off button (SF1) for 5 seconds. (Deactivate the emergency mode by pressing once.)

When VVM S320 is put in emergency mode, the display is switched off and the most basic functions are active:

- The immersion heater works to maintain the calculated supply temperature. If there is no outdoor temperature sensor (BT1), the immersion heater works to maintain the maximum supply temperature, set in menu 1.30.6 - "Highest supply heat".
- Only the circulation pumps and electric additional heat are active. Max output for the immersion heater in emergency mode, limited according to the setting in menu 7.1.8.2 - "Emergency mode".

DRAINING THE HOT WATER HEATER

The siphon principle is used to empty the hot water heater. This can be done either via the drain valve on the incoming cold water pipe or by inserting a hose into the cold water connection.

DRAINING THE CLIMATE SYSTEM

In order to carry out service on the climate system, it may be easier to drain the system first.



NOTE

There may be some hot water, risk of scalding.

1. Connect a hose to the lower filling valve for heating medium (QM11).
2. Open the valve to drain the climate system.

DATA FOR TEMPERATURE SENSOR IN THE INDOOR UNIT

Temperature (°C)	Resistance (kOhm)	Voltage (VDC)
-10	56.20	3.047
0	33.02	2.889
10	20.02	2.673
20	12.51	2.399
30	8.045	2.083
40	5.306	1.752
50	3.583	1.426
60	2.467	1.136
70	1.739	0.891
80	1.246	0.691

USB SERVICE OUTLET

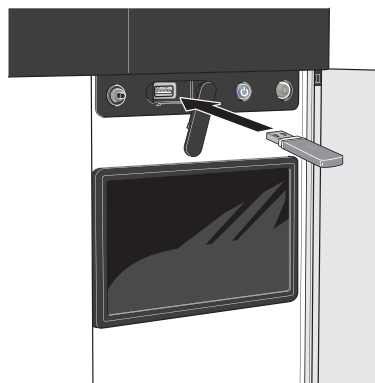

When a USB memory is connected, a new menu (menu 8) appears in the display.

Menu 8.1 - "Update the software"

You can update the software with a USB memory in menu 8.1 - "Update the software".



NOTE

In order to update using a USB memory, the memory must contain a file with software for VVM S320 from NIBE.

Software for VVM S320 can be downloaded from <https://myuplink.com>.

One or more files are shown in the display. Select a file and press "OK".



TIP

A software update does not reset the menu settings in VVM S320.



Caution

If the update is interrupted before it is complete (e.g. during a power cut), the software is automatically restored to the previous version.

Menu 8.2 - Logging

Interval

Setting range: 1 s – 60 min

Here you can choose how current measurement values from VVM S320 should be saved onto a log file on the USB memory.

1. Set the desired interval between loggings.
2. Select "Start logging".
3. The relevant measurement values from VVM S320 are now saved in a file on the USB memory at the set interval until you select "Stop logging".



Caution

Select "Stop logging" before removing the USB memory.

Logging floor drying

Here you can save a floor drying log on the USB memory and in this way see when the concrete slab reached the correct temperature.

- Make sure that "Underfloor drying function" is activated in menu 7.5.2.
- A log file is now created, where the temperature and the immersion heater output can be read off. Logging continues until "Underfloor drying function" is stopped.



Caution

Close "Underfloor drying function" before removing the USB memory.

Menu 8.3 - Manage settings

Save settings

Alternative: on/off

Display backup

Alternative: on/off

Restore settings

Alternative: on/off

In this menu, you save/upload menu settings to/from a USB memory stick.

Save settings: Here, you save menu settings in order to restore them later or to copy the settings to another VVM S320.

Display backup: Here, you save both menu settings and measurement values, e.g. energy data.



Caution

When you save menu settings to the USB memory, you replace any previously saved settings on the USB memory.

Restore settings: Here, you upload all menu settings from the USB memory stick.



Caution

Resetting of menu settings from the USB memory cannot be undone.

Manual restoring of software

If you want to restore the software to the previous version:

1. Switch off VVM S320 via the shutdown menu. The status lamp goes out, off/on button light up blue.
2. Press the on/off button once.

3. When the on/off button changes colour from blue to white, press and hold the on/off button.
4. When the status lamp changes to green, release the on/off button.



Caution

If the status lamp should turn yellow at any time, VVM S320 has ended up in emergency mode and the software has not been restored.



TIP

If you have a previous version of the software on your USB memory, you can install that instead of manually restoring the version.

Menu 8.5 - Export energy logs

From this menu, you can save your energy logs to a USB memory.

MODBUS TCP/IP

VVM S320 has built-in support for Modbus TCP/IP, which is activated in menu 7.5.9 - "Modbus TCP/IP".

TCP/IP settings are set in menu 5.2 - "Network settings".

Modbus protocol uses port 502 for communication.

Readable	ID	Description
Read	0x04	Input Register
Read writable	0x03	Holding Register
Writable multiple	0x10	Write multiple registers
Writable single	0x06	Write single register

Available registers are shown in the display for the current product and its installed and activated accessories.

Export register

1. Insert a USB memory.
2. Go to menu 7.5.9 and choose "Export most used registers" or "Export all registers". These will then be stored on the USB memory in CSV format. (These options is only shown when a USB memory in inserted in the display).

Disturbances in comfort

In most cases, VVM S320 notes a malfunction (a malfunction can lead to disruption in comfort) and indicates this with alarms, and instructions for action, in the display.

Info-menu

All the indoor module's measured values are gathered under menu 3.1 - "Operating info" in the indoor module's menu system. Examining the values in this menu can often make it easier to identify the source of the fault.

Manage alarm

In the event of an alarm, a malfunction has occurred and the status lamp shines with a steady red light. You receive information about the alarm in the smartguide on the display.

ALARM

In the event of an alarm with a red status lamp, a malfunction has occurred that VVM S320 cannot remedy itself. On the display, you can see what type of alarm it is and reset it.

In many cases, it is sufficient to select "Reset alarm and try again" for the installation to revert to normal operation.

If a white light comes on after selecting "Reset alarm and try again", the alarm has been remedied.

"Auxiliary operation" is a type of emergency mode. This means that the installation tries to produce heat and/or hot water, even though there is some kind of problem. This could mean that the compressor is not in operation. In this case, any electric additional heating produces heat and/or hot water.



Caution

To select "Auxiliary operation", an alarm action must be selected in menu 7.1.8.1 - "Alarm actions".



Caution

Selecting "Auxiliary operation" is not the same as correcting the problem that caused the alarm. The status lamp will therefore remain red.

Troubleshooting

If the operational interference is not shown in the display the following tips can be used:

BASIC ACTIONS

Start by checking the following items:

- Group and main fuses of the accommodation.
- The property's earth circuit breaker.
- Indoor unit's RCD.
- Miniature circuit breaker for VVM S320 (FC1).
- Temperature limiter for VVM S320 (FQ10).
- Correctly set load monitor.

LOW HOT WATER TEMPERATURE OR A LACK OF HOT WATER

- Closed or throttled externally mounted filling valve for the hot water.
 - Open the valve.
- Mixing valve (if there is one installed) set too low.
 - Adjust the mixer valve.
- VVM S320 in incorrect operating mode.
 - Enter menu 4.1 - "Operating mode". If "Auto" mode is selected, select a higher value for "Stop additional heat" in menu 7.1.10.2 - "Auto mode setting".
 - Hot water is produced with VVM S320 in "Manual" mode. If there is no air/water heat pump, "Additional heat" must be activated.
- Large hot water consumption.
 - Wait until the hot water has heated up. Temporarily increased hot water capacity can be activated in the "Hot water" home screen, in menu 2.1 - "More hot water" or via myUplink.
- Too low hot water setting.
 - Enter menu 2.2 - "Hot water demand" and select a higher demand mode.
- Low hot water access with the "Smart Control" function active.
 - If the hot water usage has been low for an extended period of time, less hot water than normal will be produced. Activate "More hot water" via the "Hot water" home screen, in menu 2.1 - "More hot water" or via myUplink.
- The supply temperature for the hot water is set too low.
 - Adjust the supply temperature in menu 7.1.1.3 - Domestic hot water settings.

- Too low or no operating prioritisation of hot water.
 - Enter menu 7.1.10.1 - "Operating prioritisation" and increase the time for when hot water is to be prioritised. Note that, if the time for hot water is increased, the time for heating production is reduced, which can give lower/uneven room temperatures.
- "Holiday" activated in menu 6.
 - Enter menu 6 and deactivate.

LOW ROOM TEMPERATURE

- Closed thermostats in several rooms.
 - Set the thermostats to max in as many rooms as possible. Adjust the room temperature via the "Heating" home screen, rather than turning down the thermostats.
- VVM S320 in incorrect operating mode.
 - Enter menu 4.1 - "Operating mode". If "Auto" mode is selected, select a higher value for "Stop heating" in menu 7.1.10.2 - "Auto mode setting".
 - If mode "Manual" is selected, select "Heating". If this is not enough, also select "Additional heat".
- Too low set value on the automatic heating control.
 - Adjust via the smart guide or home screen "Heating"
 - If the room temperature is only low in cold weather, the curve slope in menu 1.30.1 - "Curve, heating" may need to be adjusted upwards.
- Too low or no operating prioritisation of heat.
 - Enter menu 7.1.10.1 - "Operating prioritisation" and increase the time for when heating is to be prioritised. Note that if the time for heating is increased, the time for hot water production is reduced, which can give a smaller amount of hot water.
- "Holiday" activated in menu 6 - "Scheduling".
 - Enter menu 6 and deactivate.
- External switch for changing room temperature activated.
 - Check any external switches.
- Air in the climate system.
 - Vent the climate system.
- Closed valves to the climate system.
 - Open the valves.

HIGH ROOM TEMPERATURE

- Too high set value on the automatic heating control.
 - Adjust via the smart guide or home screen "Heating"
 - If the room temperature is only high in cold weather, the curve slope in menu 1.30.1 - "Curve, heating" may need to be adjusted downwards.
- External switch for changing room temperature activated.
 - Check any external switches.

UNEVEN ROOM TEMPERATURE.

- Incorrectly set heating curve.
 - Fine-tune the heating curve in menu 1.30.1.
- Too high set value on "dT at DOT"..
 - Go to menu 7.1.6.2 (flow set. climate system) and reduce the value of "DOT".
- Uneven flow over the radiators.
 - Adjust the flow distribution between the radiators.

LOW SYSTEM PRESSURE

- Not enough water in the climate system.
 - Fill the climate system with water and check for leaks (see chapter "Filling and venting").

THE OUTDOOR UNIT'S COMPRESSOR DOES NOT START

- There is no heating or hot water demand, nor cooling demand.
 - VVM S320 does not call on heating, hot water or cooling.
- Compressor blocked due to the temperature conditions.
 - Wait until the temperature is within the product's working range.
- Minimum time between compressor starts has not been reached.
 - Wait for at least 30 minutes and then check if the compressor has started.
- Alarm tripped.
 - Follow the display instructions.

Accessories

Detailed information about the accessories and complete accessories list available at nibe.co.uk.

Not all accessories are available on all markets.

ACTIVE COOLING ACS 310¹

ACS 310 is an accessory that enables VVM S320 to control the production of cooling.

Part no. 067 248

¹ The accessory requires that NIBE outdoor unit is installed.

ENERGY MEASUREMENT KIT EMK 300

This accessory is installed externally and used to measure the amount of energy that is supplied for the pool/hot water/heating/cooling for the house.

Part no. 067 314

ENERGY MEASUREMENT KIT EMK 500

This accessory is installed externally and used to measure the amount of energy that is supplied for the pool, hot water, heating and cooling in the building.

Part no. 067 178

EXTERNAL ELECTRIC ADDITIONAL HEAT ELK

These accessories require accessories card AXC 40 (step controlled addition).

ELK 5

Electric heater
5 kW, 1 x 230 V
Part no. 069 025

ELK 8

Electric heater
8 kW, 1 x 230 V
Part no. 069 026

EXTRA SHUNT GROUP ECS

This accessory is used when VVM S320 is installed in houses with two or more different heating systems that require different supply temperatures.

ECS 40 (Max 80 m²)

Part no 067 287

ECS 41 (approx. 80-250 m²)

Part no 067 288

HUMIDITY SENSOR HTS 40

This accessory is used to show and regulate humidity and temperatures during both heating and cooling operation.

Part no. 067 538

EXHAUST AIR UNIT S135¹

S135 is an exhaust air module specially designed to combine recovery of mechanical exhaust air with an air/water heat pump. Indoor module/control module controls S135.

Part no. 066 161

¹ The accessory requires that NIBE outdoor unit is installed.

HRV UNIT ERS

This accessory is used to supply the accommodation with energy that has been recovered from the ventilation air. The unit ventilates the house and heats the supply air as necessary.

ERS S10-400¹

Part no. 066 163

ERS 20-250¹

Part no. 066 068

ERS 30-400¹

Part no. 066 165

ERS S40-350

Part no. 066 166

¹ A preheater may be required.

BASE EXTENSION EF 45

This accessory can be used to create a larger area under VVM S320.

Part no. 067 152

AUXILIARY RELAY HR 10

Auxiliary relay HR 10 is used to control external 1 to 3 phase loads such as oil burners, immersion heaters and pumps.

Part no 067 309

COMMUNICATION MODULE FOR SOLAR ELECTRICITY EME 20

EME 20 is used to enable communication and control between inverters for solar cells from NIBE and VVM S320.

Part no. 057 215

POOL HEATING POOL 310¹

POOL 310 is an accessory that enables pool heating with VVM S320.

Part no. 067 247

¹The accessory requires the NIBE outdoor unit to be installed.

ROOM UNIT RMU S40

The room unit is an accessory with a built-in room sensor, which allows the control and monitoring of VVM S320 to be carried out in a different part of your home to where it is located.

Part no. 067 650

SOLAR PACKAGE NIBE PV

NIBE PV is a modular system comprising solar panels, assembly parts and inverters, which is used to produce your own electricity.

ACCESSORY CARD AXC 40

This accessory is used to enable connection and control of shunt-controlled additional heat, step-controlled additional heat or external circulation pump.

Part no. 067 060

WIRELESS ACCESSORIES

It is possible to connect wireless accessories to VVM S320, e.g. room, humidity, CO₂ sensors.

For more information, as well as a complete list of all available wireless accessories, see myuplink.com.

BUFFER VESSEL UKV

A buffer vessel is an accumulator tank that is suitable for connection to a heat pump or another external heat source, and can have several different applications.

UKV 40

Part no. 088 470

UKV 100

Part no. 088 207

UKV 500

Part no. 080 114

UKV 200 Cooling

Part no. 080 321

UKV 300 Cooling

Part no. 080 330

TOP CABINET TOC 30

Top cabinet, which conceals any pipes/ventilation ducts.

Height 245 mm

Part no. 067 517

Height 345 mm

Part no. 067 518

Height 385-635 mm

Part no. 067 519

Technical data

Dimensions

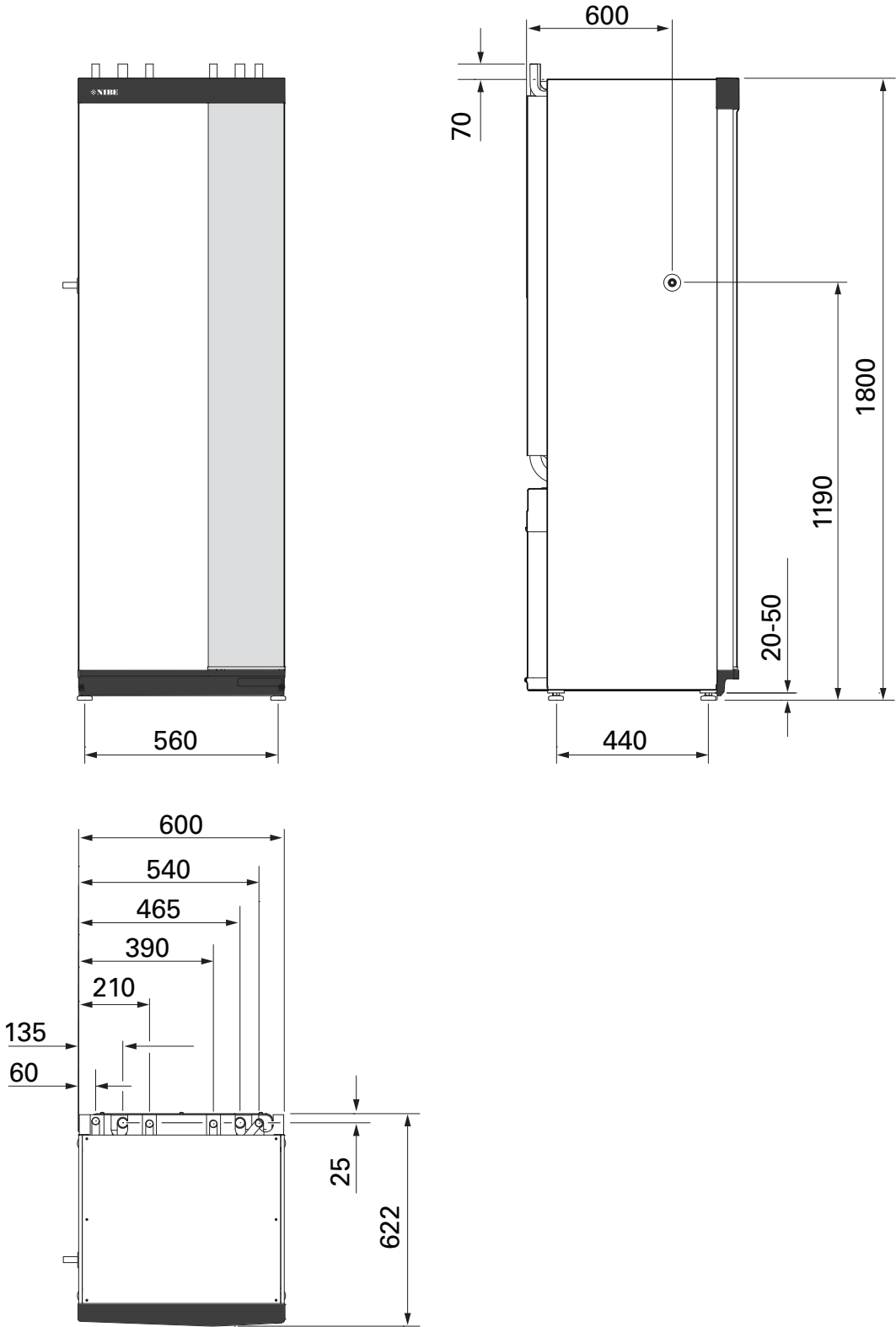

Technical specifications

Voltage		1 x 230 V
Electrical data		
Max power, immersion heater (factory setting)	kW	7 (7)
Rated voltage		230 V ~ 50 Hz
Max operating current	A	32
Fuse	A	32
Output, heating medium pump (GP1)	W	2 - 75
Power, heating medium pump 2 (GP6)	W	2 - 45
Enclosure class		IPX1B
Equipment Compliant with IEC 61000-3-12		
For Connection Design Purposes, Compliant with IEC 61000-3-3 technical requirements		
WLAN		
2.412 - 2.484 GHz max power	dbm	11
Wireless units		
2.405 - 2.480 GHz max power	dbm	4
Heating medium circuit, hot water coil		
Max system pressure heating medium	MPa (bar)	0.3 (3)
Min system pressure heating medium	MPa (bar)	0.05 (0.5)
Cut-off pressure, heating medium	MPa (bar)	0.25 (2.5)
Operating pressure (heating medium)	MPa (bar)	0.3 (3)
Max temperature, supply line (factory setting)	°C	70
Pipe connections		
Heating medium ext Ø	mm	22
Hot water connection ext Ø	mm	22
Cold water connection ext Ø	mm	22
Heat pump connections ext Ø	mm	22
Hot water and heating section		
Volume, hot water heater (Rf)	litre	173
Volume coil (Rf)	litre	7.7
Volume primary, Heating medium coil	litre	8
Volume, total indoor	litre	206
Volume buffer vessel	litre	22
Max. permitted pressure in hot water heater	MPa (bar)	1.0 (10)
Min. permitted pressure in hot water heater	MPa (bar)	0.01 (0.1)
Cut-off pressure in hot water heater	MPa (bar)	0.9 (9)
Capacity, hot water heating according to EN16147		
Tap volume 40 °C (comfort mode Medium) - Rf	litre	207
Tested according to EN 12897:2016		
Maximum water supply pressure	MPa (bar)	1.6 (16)
Operating pressure, tap water	MPa (bar)	0.6 (6.0)
Expansion vessel, tap water, precharge pressure	MPa (bar)	0.35 (3.5)
Volume expansion vessel (external)	litre	25
Pressure relief valve, setting	MPa (bar)	0.35 (3.5)
Opening pressure T&P-valve	MPa (bar)	0.7 (7.0)
Max operating temperature T&P-valve	°C	95
Discharge capacity of T&P-valve	kW	25
Set opening pressure expansion relief valve	MPa (bar)	0.6 (6.0)
Cut out, temperature limiter	C	89
Reheating time VVM S320	min.	19
Capacity charge coil, 10 °C to 60 °C, primary flow 900 l/h	kW	29.89
Pressure drop at 0.25 l/s	kPa	13
Equivalent amount of hot water (40 °C)	litre	271
Idle loss	kWh/24 h	2.71
Dimensions and weight		
Width	mm	600
Depth	mm	615
Height	mm	1,800
Required ceiling height ¹	mm	1,960
Net weight (excl. packaging and without water)	kg	123

Voltage		1 x 230 V
Mass unit, filled with water (filled with water)	kg	330
Part no.		
Part no.		069 199

¹ With feet removed, the height is approx. 1,940 mm.

Electrical circuit diagram

1X230 V

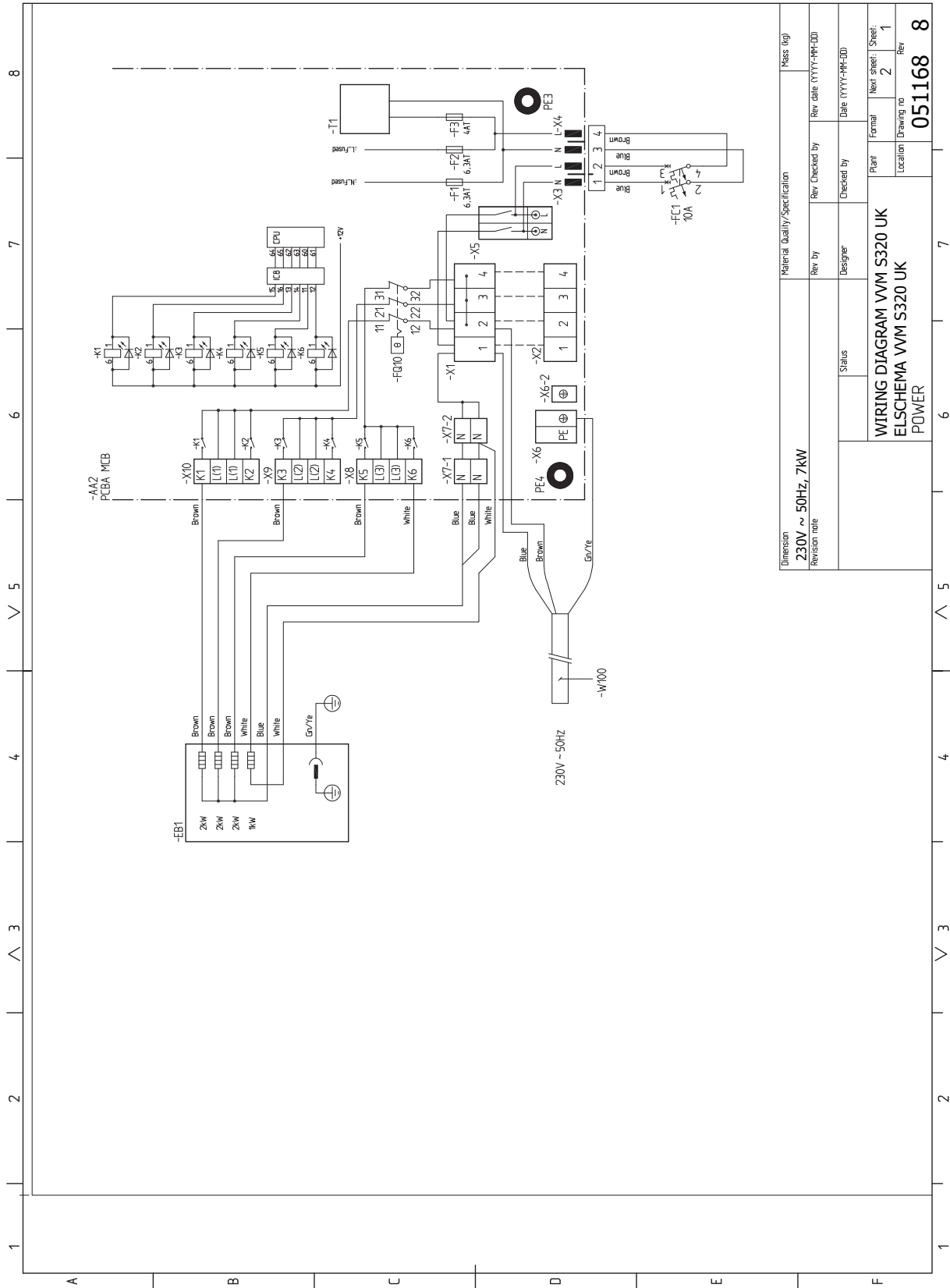

Dimension	Material Quality/Specification		Mass (kg)
Revision note	230V ~ 50Hz, 7kW		
Rev. by	Rev. checked by	Rev. date (YYYY-MM-DD)	
Status	Designer	Checked by	Date (YYYY-MM-DD)
WIRING DIAGRAM VVM S320 UK ELSCHEMA VVM S320 UK POWER			
Plant	Format	Next sheet	Sheet
Location	Drawing no	051168	8

1

2

3

4

5

6

7

8

A

B

C

D

E

F

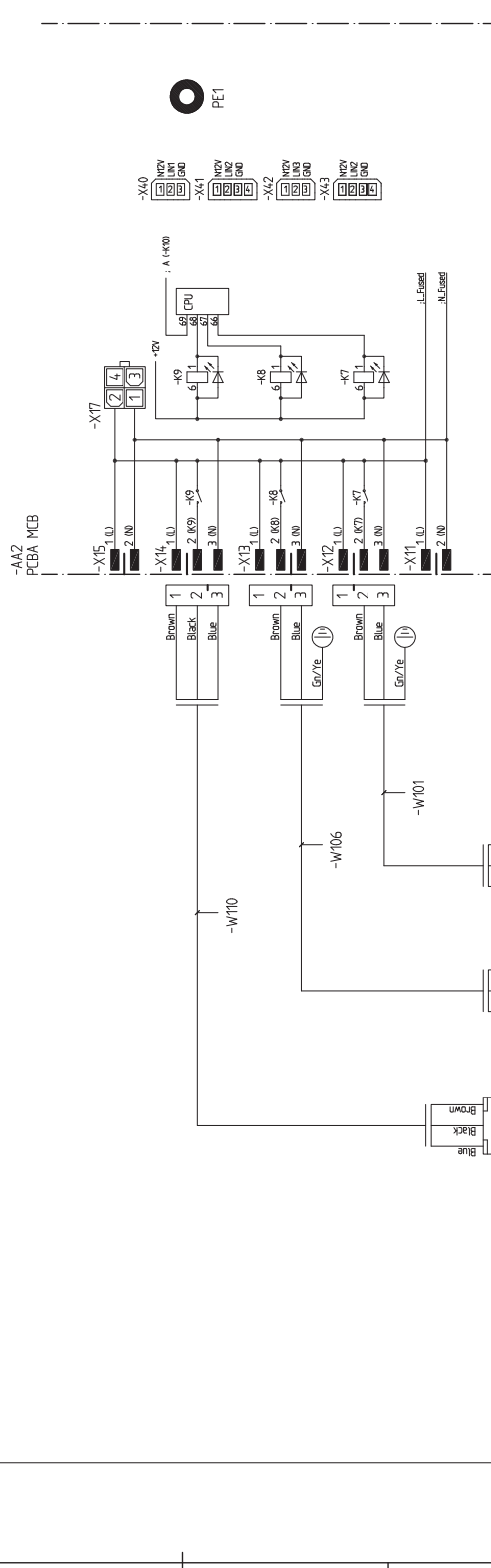

Material Quality Specification		Mass (kg)	
Rev	Checked by	Rev	Date (YYYY-MM-DD)
1	Designer	1	2018-03-23
2	Checked by	2	2018-03-23
3	Checked by	3	2018-03-23

Dimension		Revision note	
Dimension	Revision note	Dimension	Revision note
230V ~ 50Hz, 7kW			

WIRING DIAGRAM VVM S320 UK		ELSCHEMA VVM S320 UK	
Status	Plant	Formal	Next sheet: Sheet
	Wiring	3	2
	Location	Drawing no	Rev
		051168	8

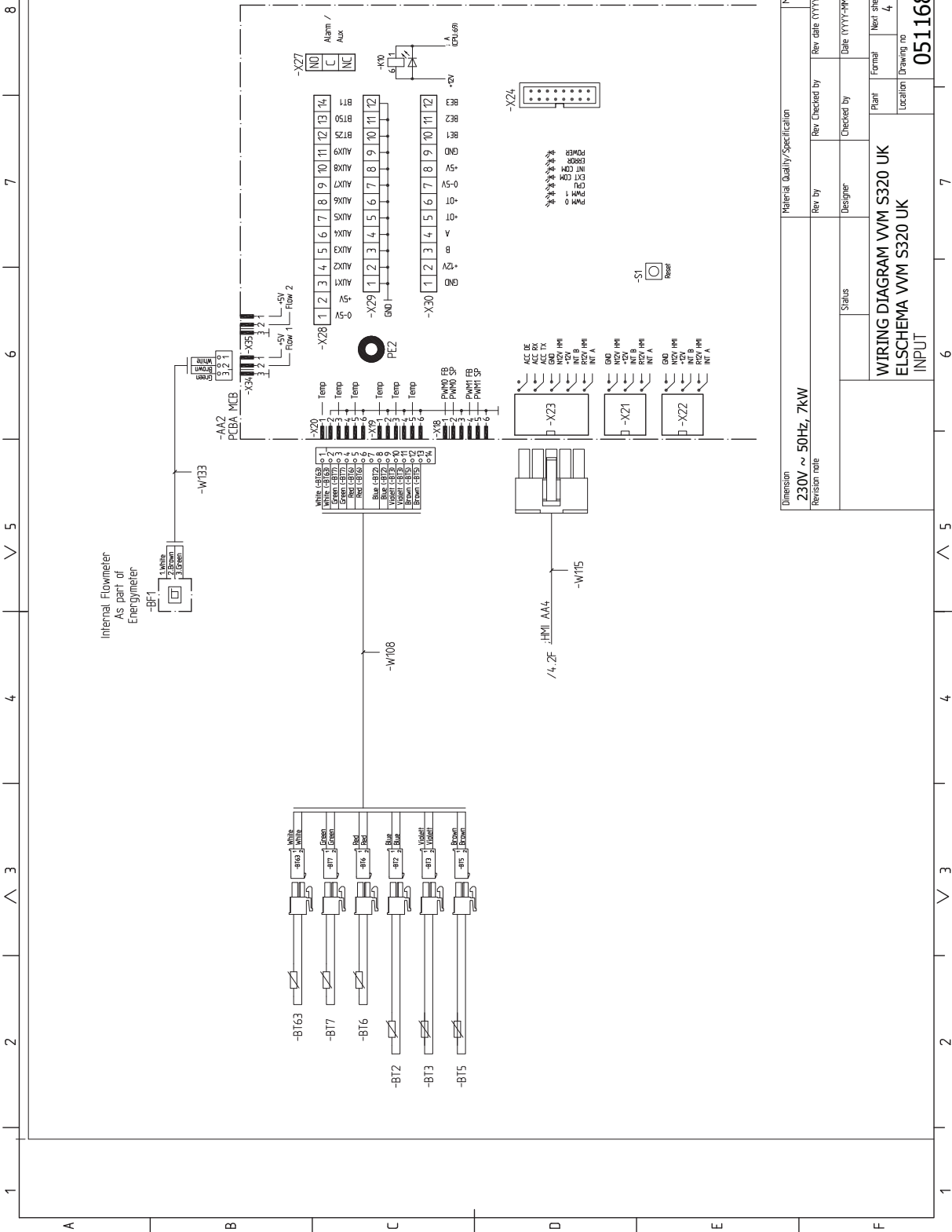

Material Quality/Specification		Mass (kg)	
Dimension	230V ~ 50Hz, 7kW	Rev by	Rev date (YYYY-MM-DD)
Revision note		Designer	Checked by
Status		Plant	Formal
WIRING DIAGRAM WVM S320 UK		Location	Next sheet: Sheet: 3
ELSCHEMA WVM S320 UK		Drawing no	Rev
INPUT		051168	8

8

7

6

5

4

3

2

1

A

B

C

D

E

F

-AA4
PCBA HMI

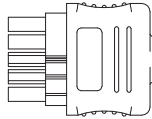
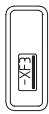
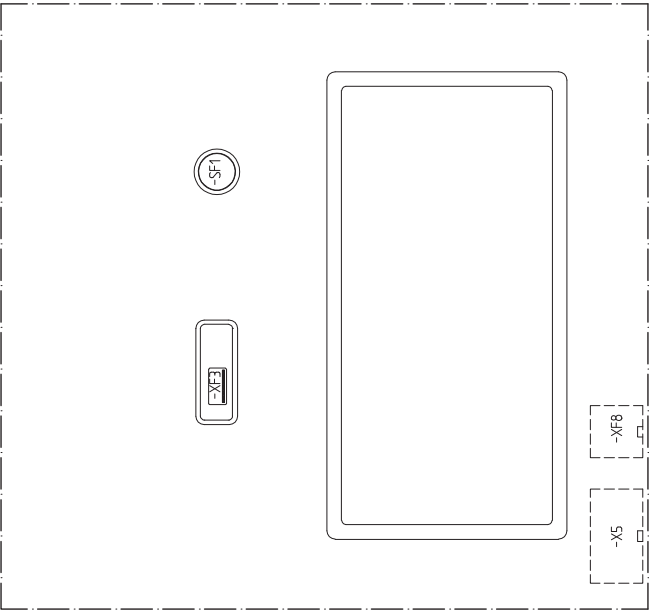

-W15
/3.40 HMI AA4

Dimension	Material Quality/Specification		Mass (kg)
230V ~ 50Hz, 7kW	Rev by	Rev Checked by	Rev date (YYYY-MM-DD)
Revision note	Status	Checked by	Date (YYYY-MM-DD)
	Designer	Plant	Formal
		Location	Next sheet: Sheet: 4
			Drawing no
			Rev
			051168
			8

Item register

- A**
- Accessories, 65
- Alarm, 63
- Areas with hard water, 16
- Assembly, 8
- C**
- Cleaning the climate system, 16
- Climate system, 20
- Climate systems and zones, 39
 - Control - Introduction, 39
- Cold and hot water, 20
 - Connecting cold and hot water, 20
- Commissioning and adjusting, 30
 - Commissioning without heat pump, 32
 - Filling and venting, 30
 - Preparations, 30
 - Setting the cooling/heating curve, 32
 - Start guide, 31
 - Start-up and inspection, 31
- Commissioning without heat pump, 32
- Communication, 26
- Compatible outdoor units, 7
- Connecting accessories, 26
- Connecting external operating voltage for the control system, 24
- Connecting hot water circulation, 21
- Connecting sensors, 25
- Connecting the climate system, 20
- Connections, 24
- Control, 36
 - Control - Introduction, 36
- Control - Introduction, 36
- Control - Menus
 - Menu 1 - Indoor climate, 40
 - Menu 2 - Hot water, 44
 - Menu 3 - Info, 46
 - Menu 4 - My system, 47
 - Menu 5 - Connection, 51
 - Menu 6 - Scheduling, 52
 - Menu 7 - Service, 53
- Country specific information, 5
- D**
- Delivery and handling, 8
 - Assembly, 8
 - Installation area, 8
 - Removing the covers, 10
 - Supplied components, 9
 - Transport, 8
- Dimensions, 67
- Disruption to comfort
 - Info menu, 63
- Disturbances in comfort, 63
 - Alarm, 63
 - Manage alarm, 63
 - Troubleshooting, 63
- Docking alternatives
 - Two or more climate systems, 20
- Draining the climate system, 61
- Draining the hot water heater, 60
- E**
- Electrical addition - maximum output, 29
 - Power steps of the immersion heater, 29
- Electrical circuit diagram, 70
- Electrical connection, 22
 - General, 22
- Electrical connections, 22
 - Communication, 26
 - Connecting accessories, 26
 - Connecting external operating voltage for the control system, 24
 - Connecting sensors, 25
 - Connections, 24
 - Electrical addition - maximum output, 29
 - External connection options, 27
 - External connections, 25
 - External energy meter, 25
 - External supply temperature sensor, 25
 - Load monitor, 26
 - Outdoor sensor, 25
 - Outdoor units, 26
 - Power connection, 24
 - Room sensor, 25
 - Settings, 29
 - Supply voltage, 24
- External connection options, 27
 - Possible selection for AUX inputs, 27
 - Possible selection for AUX output (potential free variable relay), 28
- External connections, 25
- External energy meter, 25
- External supply temperature sensor, 25
- F**
- Filling , 30
- Filling and venting, 30
 - Filling , 30
 - Filling the hot water heater, 30
 - Venting the climate system, 30
- Filling the hot water heater, 30
- H**
- Heating medium side, 20
- Help menu, 37
- I**
- Important information, 4
 - Compatible outdoor units, 7
 - Country specific information, 5
 - Inspection of the installation, 6
 - Marking, 4
 - Safety information, 4
 - Symbols, 4
- Indoor module's design, 12
 - Component locations, 12
- Info menu, 63
- Inspection of the installation, 6
- Installation alternative, 20
 - Connecting hot water circulation, 21
 - Water heater with immersion heater, 21
- Installation area, 8
- L**
- Load monitor, 26
- M**
- Manage alarm, 63
- Marking, 4
- Menu 1 - Indoor climate, 40

- Menu 2 - Hot water, 44
- Menu 3 - Info, 46
- Menu 4 - My system, 47
- Menu 5 - Connection, 51
- Menu 6 - Scheduling, 52
- Menu 7 - Service, 53
- Modbus TCP/IP, 62
- myUplink, 35
- N**
- Navigation
 - Help menu, 37
- O**
- Outdoor modules, 26
- Outdoor sensor, 25
- P**
- Pipe and ventilation connections
 - Climate system, 20
 - Connecting the climate system, 20
- Pipe connections, 15
 - Boiler and radiator volumes, 17
 - Cold and hot water
 - Connecting cold and hot water, 20
 - General
 - Areas with hard water, 16
 - Cleaning the climate system, 16
 - General pipe connections, 15
 - Heating medium side, 20
 - Installation alternative, 20
 - Pipe coupling, heating medium, 19
 - Symbol key, 17
 - System diagram, 18
 - Use without heat pump, 20
- Pipe coupling, heating medium, 19
- Possible selection for AUX inputs, 27
- Possible selection for AUX output (potential free variable relay), 28
- Power connection, 24
- Preparations, 30
- Pump speed, 32
- R**
- Removing the covers, 10
- Room sensor, 25
- S**
- Safety information, 4
 - Marking, 4
 - Serial number, 4
 - Symbols, 4
 - Warranty information, 5
- Serial number, 4
- Service, 60
 - Service actions, 60
- Service actions, 60
 - Draining the climate system, 61
 - Draining the hot water heater, 60
 - Modbus TCP/IP, 62
 - Standby mode, 60
 - Temperature sensor data, 61
 - USB service outlet, 61
- Settings, 29
 - Emergency mode, 29
- Setting the cooling/heating curve, 32
- Standby mode, 29, 60
- Start guide, 31
- Start-up and inspection, 31
 - Pump speed, 32
- Supplied components, 9
- Supply voltage, 24
- Symbol key, 17
- Symbols, 4
- System diagram, 18
- T**
- Technical data, 67
 - Dimensions, 67
 - Electrical circuit diagram, 70
 - Technical Data, 68
- Technical Data, 68
- Temperature sensor data, 61
- Transport, 8
- Troubleshooting, 63
- U**
- USB service outlet, 61
- Use without heat pump, 20
- V**
- Venting the climate system, 30
- W**
- Warranty information, 5

SERVICE RECORD

It is recommended that your hot water system is serviced regularly and that the appropriate Service Record is completed.

Service Provider

Before completing the appropriate Service Record below, please ensure you have carried out the service as described in the manufacturer's instructions.

SERVICE 1 Date

Engineer Name

Company Name

Telephone Number

Comments

Signature

SERVICE 2 Date

Engineer Name

Company Name

Telephone Number

Comments

Signature

SERVICE 3 Date

Engineer Name

Company Name

Telephone Number

Comments

Signature

SERVICE 4 Date

Engineer Name

Company Name

Telephone Number

Comments

Signature

SERVICE 5 Date

Engineer Name

Company Name

Telephone Number

Comments

Signature

SERVICE 6 Date

Engineer Name

Company Name

Telephone Number

Comments

Signature

SERVICE 7 Date

Engineer Name

Company Name

Telephone Number

Comments

Signature

SERVICE 8 Date

Engineer Name

Company Name

Telephone Number

Comments

Signature

SERVICE 9 Date

Engineer Name

Company Name

Telephone Number

Comments

Signature

SERVICE 10 Date

Engineer Name

Company Name

Telephone Number

Comments

Signature

NIBE Energy Systems Ltd
3C Broom Business Park,
Bridge Way, S41 9QG Chesterfield
Tel: +44 (0)330 311 2201
info@nibe.co.uk
nibe.co.uk

IHB EN 2327-1 631815

This is a publication from NIBE Energy Systems. All product illustrations, facts and data are based on the available information at the time of the publication's approval.

NIBE Energy Systems makes reservations for any factual or printing errors in this publication.

©2023 NIBE ENERGY SYSTEMS

