



Ground source heat pump

NIBE S1156

NIBE S1156 is an intelligent, inverter-controlled ground source heat pump with new, more climate friendly refrigerant. The product is without integrated hot water heater, which makes it easy to place under low ceiling heights. Separate hot water heater is selected depending on hot water demand. S1156 helps you with not using more energy than you need since the heat pump adapt automatically after your need of heat. With a long experience of ground source heat pumps and innovative technology it is our most energy-efficient ground source heat pump.

NIBE S1156 has a high seasonal performance factor up to 6,22 in SCOP which results in high effective climate unit resulting in low operating costs and hot water with high performance. The heat pump is suitable for house up to circa 400 m² and is available in three different output sizes: 1,5–8 kW, 3–13 kW and 4–18 kW. NIBE S1156 is designed for low noise level and is suitable for both new builds and replacing existing heat sources.

NIBE S-series with integrated wifi and the possibility to use wireless accessories is a natural part of your connected home. The smart technology adjusts the indoor climate automatically while you are in complete control from your phone or tablet. Giving high comfort and low energy consumption, while doing nature a favour at the same time.

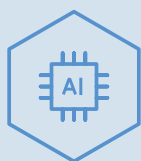

- **Our most energy-efficient ground source heat pump with a seasonal performance factor up to 6,22 in SCOP.**
- **New, more climate friendly refrigerant, high hot water capacity and low noise level.**
- **User-friendly touch control and integrated wireless connectivity with energy saving smart technology for high comfort.**

This is how S1156 works

Installation method

Rock

S1156 collects a proportion of the rock's stored solar energy via a collector in a borehole in the rock.

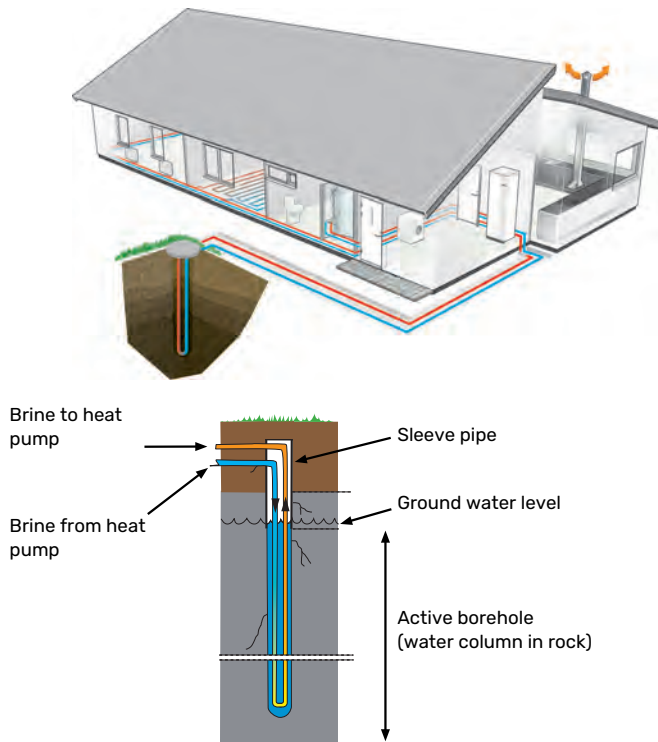

Lake

S1156 collects a proportion of the water's stored solar energy via a lake collector that is anchored on the lake bed.

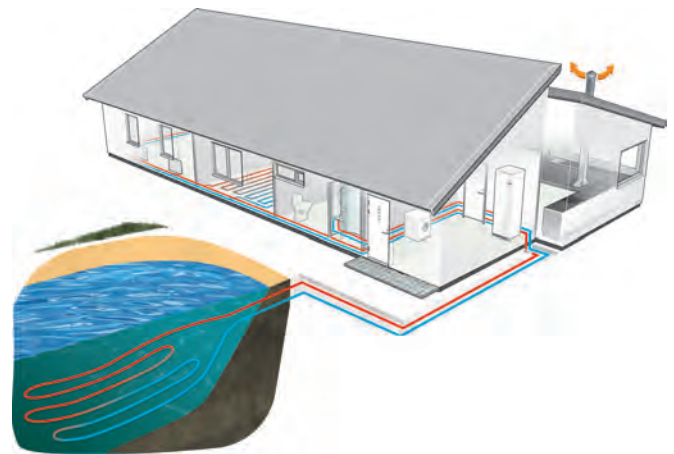

Ground

S1156 collects a proportion of the ground's stored solar energy via a buried ground collector.

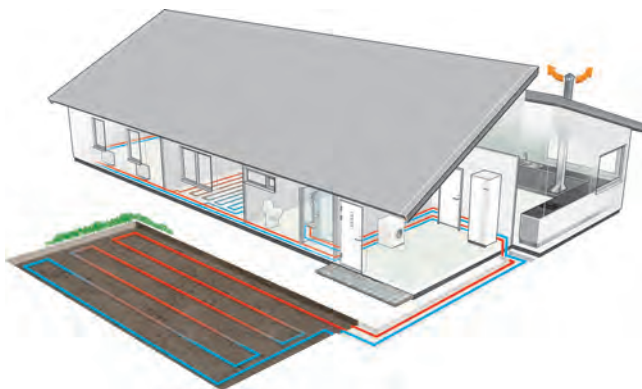

Design

S1156 has no integrated water heater, but is available as an accessory with corrosion protection made of copper, enamel or stainless steel. S1156 has an integrated immersion heater of 7 kW, with seven steps that engage automatically as necessary. This can be switched to four steps of 9 kW.

S1156 is constructed on a robust frame with durable panels and effective soundproofing for the best possible comfort. All panels are easy to remove to facilitate installation and for any servicing.

Principle of operation

S1156 consists of heat pump, immersion heater, circulation pumps and control system. S1156 is connected to the brine and heating medium circuits.

The heat from the heat source (rock, soil, lake) is taken up via a closed brine system in which a mixture of water and antifreeze circulates. In some cases, the ground water can also be used as a heat source. An intermediate heat exchanger should be used to protect the heat pump in such cases.

In the heat pump evaporator, the brine (water mixed with anti-freeze, glycol or ethanol) releases its energy to the refrigerant, which is vaporised in order to be compressed in the compressor. The refrigerant, of which the temperature has now been raised, is passed to the condenser where it gives off its energy to the heating medium circuit and, if necessary, to any docked water heater. If there is a greater need for heating/hot water than the compressor can provide there is an integrated immersion heater.

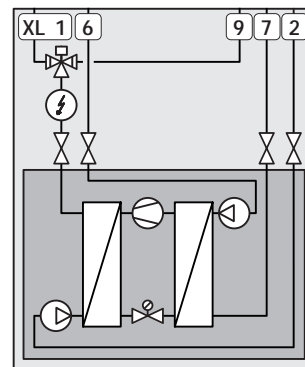

XL1	Connection, heating medium flow
XL2	Connection, heating medium return
XL6	Connection, brine in
XL7	Connection, brine out
XL9	Connection, hot water heater

Good to know about S1156

Transport and storage

S1156 should be transported and stored vertically in a dry place. When being moved into a building, S1156 may be leant back 45 °.

The product can be tail heavy.

If the cooling module is pulled out and transported upright, S1156 can be transported on its back.

Remove the outer panels in order to protect them when moving in confined spaces inside buildings.

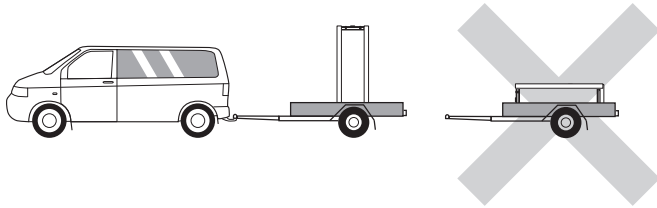

EXTRACTING THE COOLING MODULE

To simplify transport and service, the heat pump can be separated by pulling the cooling module out from the cabinet.

See section "Service" in the installer manual for comprehensive instructions about the separation.

Installation and positioning

- Position S1156 on a solid foundation indoors that withstands water and the weight of the product.
- Since water comes from S1156, the area where S1156 is located must be equipped with floor drainage.
- Install with its back to an outside wall, ideally in a room where noise does not matter, in order to eliminate noise problems. If this is not possible, avoid placing it against a wall behind a bedroom or other room where noise may be a problem.
- Wherever the unit is located, walls to sound sensitive rooms should be fitted with sound insulation.
- Route pipes so they are not fixed to an internal wall that backs on to a bedroom or living room.

INSTALLATION AREA

Leave a free space of 800 mm in front of the product. Approx. 50 mm free space is required on each side, to allow the side panels to be removed (see image). All service on S1156 can be carried out from the front, however the right-hand panel may need to be removed. Leave free space between the heat pump and the wall behind (and any routing of supply cables and pipes), to reduce the risk of any vibrations being propagated.

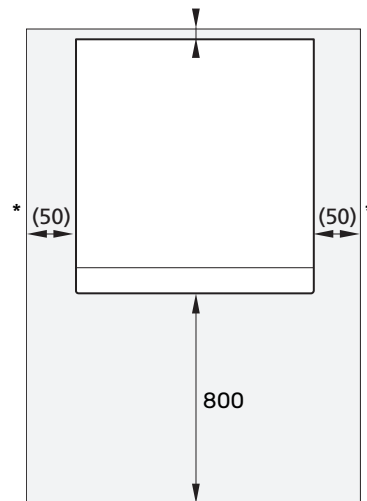

* A normal installation needs 300 – 400 mm (any side) for connection equipment, e.g. level vessel, valves and electrical equipment.

Supplied components

Local differences in the enclosed kit may occur. See relevant installer manual for more information.

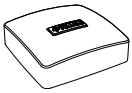

Outdoor temperature sensor
1 x



Room sensor
1 x



Current sensor¹
3 x



O-rings
8 x



Temperature sensor
3 x

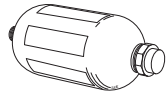

Level vessel¹
1 x



Aluminium tape
1 x

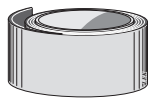

Insulation tape
1 x



Safety valve
0.3 MPa (3 bar)¹
1 x



Filterball
8 kW
1 x G1
1 x G3/4
13 kW
1 x G1
1 x G1 1/4
18 kW
1 x G1
1 x G1 1/4



Compression ring
couplings
8 kW
2 x (ø28 x G25)
3 x (ø22 x G20)
13 kW
5 x (ø28 x G25)
18 kW
5 x (ø28 x G25)

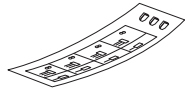

Label for external control voltage for the control system
1 x

¹ Not Italy and the DACH countries.

Installation

Inspection of the installation

Current regulations require the heating installation to be inspected before it is commissioned. The inspection must be carried out by a suitably qualified person.

Pipe installation

Pipe installation must be carried out in accordance with current norms and directives. S1156 can operate with a return temperature of up to 58 °C and an outgoing temperature from the heat pump of 70 (65 °C with only the compressor).

S1156 is not equipped with external shut off valves; these must be installed to facilitate any future servicing.

Water may drip from the safety valve's overflow pipe. The overflow pipe must be routed to a suitable drain, to prevent hot water splashes from causing harm. The overflow pipe must be inclined along its entire length to prevent pockets where water can accumulate, and must be frost-proof. The overflow pipe must be at least the same size as the safety valve. The overflow pipe must be visible and its mouth must be open and not placed close to electrical components.

BRINE



The brine transports energy from a source to the heat pump using a liquid consisting of water mixed with antifreeze. The brine must be mixed to ensure that the freezing point is lower than -15 °C.

Insulate all indoor brine pipes against condensation.

Mark the brine system with the antifreeze that is used.

Install as follows:

- enclosed level vessel /expansion vessel

The level vessel must be installed as the highest point in the brine system on the incoming pipe before the brine pump (Alternative 1). If the level vessel cannot be placed at the highest point, an expansion vessel must be used (Alternative 2).

Note that condensation may drip from the level vessel. Position the vessel so that this does not harm other equipment.

- enclosed safety valve

The safety valve is fitted below the level vessel.

- pressure gauge

The pressure gauge is only required if an expansion vessel is used.

- shut-off valve

Install the shut-off valve as close to S1156 as possible.

- enclosed filterball

Install the filterball as close to S1156 as possible.

If filling connection KB25/KB32 is used, the enclosed filterball does not need to be fitted.

- vent valve

When necessary you should install venting valves in the brine system.

In the case of connection to an open groundwater system, an intermediate frost-protected circuit must be provided, because of the risk of dirt and freezing in the evaporator. This requires an extra heat exchanger.

Side connection

It is possible to angle the brine connections, for connection to the side instead of top connection.

CLIMATE SYSTEM



A climate system is a system that regulates indoor comfort with the help of the control system in S1156 and for example radiators, underfloor heating/cooling, fan convectors etc.

- Install all necessary safety devices, shut-off valves (as close to the heat pump as possible) and the enclosed filterball.
- Install safety valve. The recommended opening pressure is 0.25 MPa (2.5 bar). For information about max. opening pressure, see the technical specifications.
- When connecting to a system with thermostats on all radiators (or underfloor heating coils), either a bypass valve must be fitted or some of the thermostats must be removed to ensure there is sufficient flow.

COLD AND HOT WATER



If S1156 is not docked to a water heater, the connection for the water heater must be plugged.

Any docked hot water heater must be fitted with

- necessary set of valves.
- A mixer valve must also be installed, if the factory setting for hot water is changed. National regulations must be observed.
- The safety valve must have max. 1.0 MPa (10.0 bar) opening pressure, and be installed on the incoming domestic water line.

Ensure that incoming water is clean. When using a private well, it may be necessary to supplement with an extra water filter.

For more information see nibe.eu.

Guideline values for collectors

The length of the collector hose varies depending on the rock/soil conditions, climate zone and on the climate system (radiators or underfloor heating) and the building's power requirement. Each installation must be sized individually. The brine pump's capacity must be taken into consideration when sizing the collector.

In those cases where it is necessary to have several collectors, these should be connected in parallel with the possibility for adjusting the flow of the relevant coil.

For surface soil heat, the hose should be buried at a depth determined by local conditions and the distance between the hoses should be at least 1 metre.

For several bore holes, the distance between the holes must be determined according to local conditions.

Ensure the collector hose rises constantly towards the heat pump to avoid air pockets. If this is not possible, airvents should be used.

Because the temperature of the brine system can fall below 0 °C, it must be protected against freezing down to -15 °C. When making the volume calculation, use 1 litres of ready mixed brine per metre of collector hose (applies when using PEM-hose 40x2.4 PN 6.3) as a guide value.

Installation alternative

VENTILATION RECOVERY



The installation can be supplemented with the exhaust air module NIBE FLM S45 to provide ventilation recovery. FLM S45 is equipped with a built-in fan specially designed to combine recovery of mechanical exhaust air with an energy collector in rock or in the ground.

- Pipes and other cold surfaces must be insulated with diffusion-proof material to prevent condensation.
- The brine system must be supplied with a pressure expansion vessel. If there is a level vessel this should be replaced.

FREE COOLING



The accessory PCS 44 allows the connection of passive cooling, for example with fan coils. The cooling system is connected to the heat pump brine circuit, whereby cooling is supplied from the collector or via a circulation pump and shunt valve.

- Pipes and other cold surfaces must be insulated with diffusion-proof material to prevent condensation.
- Where the cooling demand is high, fan convectors with drip trays and drain connection are needed.
- The brine system must be supplied with a pressure expansion vessel. If there is a level vessel this should be replaced.

TWO OR MORE CLIMATE SYSTEMS



In buildings with several climate systems that require different supply temperatures, the accessory ECS 40/ECS 41 can be connected.

A shunt valve then lowers the temperature to the underfloor heating system, for example.

POOL



With the POOL 40 accessory, you can heat the pool with your system.

During pool heating, the heating medium circulates between the S1156 and the pool exchanger using the heat pump's internal circulation pump.

Functions

Control, general

The indoor temperature depends on several different factors. Sunlight and heat emissions from people and household machines are normally sufficient to keep the house warm during the warm seasons. When it gets colder outside, the climate system needs to help heat the house. The colder it is outside, the warmer radiators and underfloor heating systems have to be.

The heat pump is controlled by built-in supply and return brine temperature sensors (collector). Brine return temperatures can, if necessary, be limited to a minimum e.g. for ground water systems.

Control of the heat production is performed based on the "floating condensing" principle, which means that the temperature level needed for heating at a specific outdoor temperature is produced based on collected values from the outdoor and supply temperature sensors. The room sensor can also be used to compensate the deviation in room temperature.

Heat production



The supply of heat to the house is regulated in accordance with the selected heating curve setting. After adjustment, the correct amount of heat for the current outdoor temperature is supplied. The supply temperature will oscillate around the theoretically desired value.

OWN CURVE

S1156 has pre-programmed non-linear heating curves. It is also possible to create your own defined curve. This is an individual linear curve with a number of break points. You select break points and the associated temperatures.

Hot water production



If the water heater is docked to S1156 and there is a hot water demand, the heat pump's software control prioritizes the hot water charging mode with optimal heat pump power.

Hot water charging starts when the temperature has fallen to the set start temperature. Hot water charging stops when the hot water temperature at the hot water sensor has been reached.

For temporary higher hot water demand, there is a function that allows the temperature to be raised temporarily for up to 12 hours or by a one time increase (can be selected in the menu system).

With the Smart Control function activated, S1156 learns how much hot water is used and when. The Smart Control function memorises the previous week's hot water consumption and adapts the hot water temperature for the coming week to ensure minimal energy consumption.

It is also possible to set S1156 in holiday mode, which means that the lowest possible temperature is achieved without the risk of freezing.

Multi-installation



Several heat pumps can be interconnected by selecting one heat pump as the main unit and the others as subordinate heat pumps.

Ground source heat pumps with multi-installation functionality from NIBE can be connected to S1156.

A further eight heat pumps can be connected to the main unit. In systems with several heat pumps, each pump must have a unique name. Only one heat pump can be "Main unit" and only one can be, for example, "Heat pump 5".

External temperature sensors and control signals must only be connected to the main unit, except for external control of the compressor module.

Additional heat only



S1156 can be used exclusively as an additional heater, (max 9 kW) to produce heat and any hot water, for example before the collector system is complete.

Alarm indications



In the event of an alarm, a malfunction has occurred and the status lamp shines with a steady red light. You receive information about the alarm in the smartguide on the display.

Floor drying



S1156 has an integrated underfloor drying function. This allows for controlled drying of concrete slabs. It is possible to create your own program or to follow a pre-programmed time and temperature schedule.

Brine control



For users who are going to replace an existing heat pump.

The risk of over-exploiting the collector system is reduced with the smart integrated brine control. This function can be used when replacing older heat pump systems where the collector may be undersized for a modern heat pump with a higher COP and SCOP.

An undersized collector can result in additional heat being required to assist on the coldest days of the year.

myUplink



With myUplink you can control the installation – where and when you want. In the event of any malfunction, you receive an alarm directly to your e-mail or a push notification to the myUplink app, which allows you to take prompt action.

Visit myuplink.com for more information.

SPECIFICATION

You need the following in order for myUplink to be able to communicate with your S1156:

- wireless network or network cable
- Internet connection
- account on myuplink.com

We recommend our mobile apps for myUplink.

RANGE OF SERVICES

myUplink gives you access to various levels of service. The base level is included and, apart from this, you can choose two premium services for a fixed annual fee (the fee varies depending on the functions selected).

Service level	Basic	Premium extended history	Premium change settings
Viewer	X	X	X
Alarm	X	X	X
History	X	X	X
Extended history	-	X	-
Manage	-	-	X

MOBILE APPS FOR MYUPLINK

The mobile apps can be downloaded free of charge from where you usually download your mobile apps. Logging into the mobile app is performed using the same account details as on myuplink.com.

NIBE SMART PRICE ADAPTION™



Smart Price Adaption is not available in all countries. Contact your NIBE dealer for more information.

Smart Price Adaption adjusts the system's consumption according to the time of day when electricity prices are lowest. This allows for savings, provided that an hourly rate subscription has been signed with the electricity supplier.

The function is based on hourly rates for the coming day being downloaded via myUplink. To use the function, an Internet connection and account on myUplink are necessary.

WIRELESS UPDATES



When the heat pump is connected, there is the option to receive wireless updates. This provides the heat pump with new functions, giving a better experience. To receive wireless updates, you have to create an account on myUplink.

SMART HOME

When you have a smart home system that can communicate with myUplink, you can control the installation via an app by activating the "smart home" function.

By allowing connected units to communicate with myUplink, your heating system becomes a natural part of your homesmart home and gives you the opportunity to optimise the operation.

Remember that the "smart home" function requires myUplink in order to work.

NIBE SMART ENERGY SOURCE™



Smart Energy Source™ prioritises how / to what extent each docked energy source will be used.

Here you can choose if the system is to use the energy source that is cheapest at the time. You can

also choose if the system is to use the energy source that is most carbon neutral at the time.

Wireless accessories



To benefit from S1156's full potential, the wireless accessories are the solution. This means new opportunities for you, and provides a more demand-adapted indoor comfort and lower energy consumption.

With a S1156 connected, you are already able to control and monitor your heating system easily via myUplink. With the new smart accessories, you can enjoy an even better and more comfortable life.

The display



S1156 is controlled using a clear and easy to use display.

Instructions, settings and operational information are shown on the display. You can easily navigate between the different menus and options to set the comfort or obtain the information you require.

Technical data

Dimensions

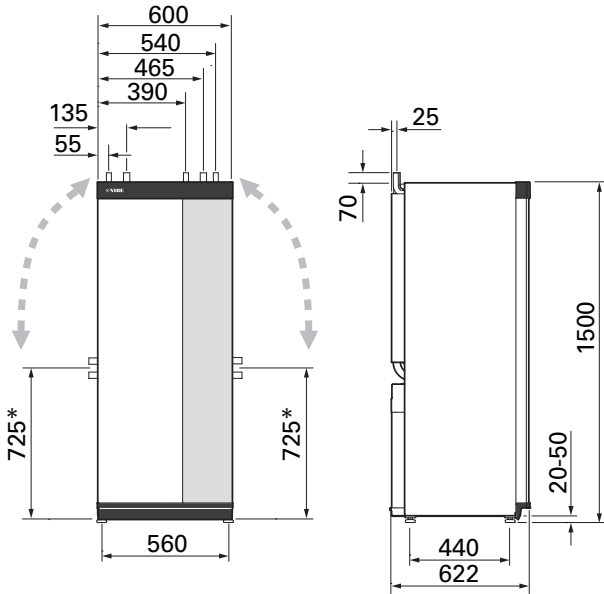

* Can be angled for side connection

Pipe connections

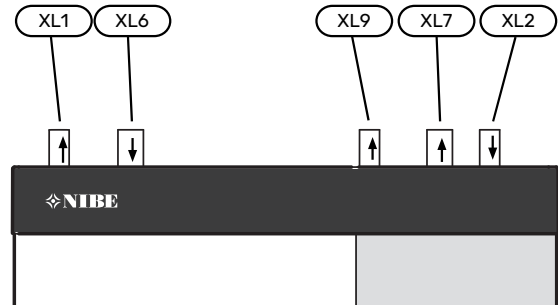

PIPE DIMENSIONS

Connection		8 kW	13 kW	18 kW
(XL1)/(XL2) Heating medium supply/return ext. Ø	(mm)	22		28
(XL9) Connection water heater ext. Ø	(mm)	22		28
(XL6)/(XL7) Brine in/out ext. Ø	(mm)		28	

Technical specifications

ELECTRICAL DATA

1x230 V

S1156-8		
Rated voltage		230V ~ 50Hz
Max operating current including 0 kW immersion heater (Recommended fuse rating).	A _{rms}	14(16)
Max operating current including 0.5 kW immersion heater (Recommended fuse rating).	A _{rms}	16(16)
Max operating current including 1.5 kW immersion heater (Recommended fuse rating).	A _{rms}	20(20)
Max operating current including 2.5 kW immersion heater (Recommended fuse rating).	A _{rms}	24(25)
Max operating current including 4 kW immersion heater (Recommended fuse rating).	A _{rms}	31(32)
Max operating current including 4.5 kW immersion heater (Recommended fuse rating).	A _{rms}	33(40)
Additional power	kW	0.5/1/1.5/2/2.5/3 /3.5/4/4.5

S1156-13		
Rated voltage		230 V ~ 50 Hz
Max operating current including 0 kW immersion heater (Recommended fuse rating).	A _{rms}	22(25)
Max operating current including 1 kW immersion heater (Recommended fuse rating).	A _{rms}	26(32)
Max operating current including 2 kW immersion heater (Recommended fuse rating).	A _{rms}	30(32)
Max operating current including 4 kW immersion heater (Recommended fuse rating).	A _{rms}	39(40)
Max operating current including 6 kW immersion heater (Recommended fuse rating).	A _{rms}	48(50)
Max operating current including 7 kW immersion heater (Recommended fuse rating).	A _{rms}	52(63)
Additional power	kW	1/2/3/4/5/6/7

3x230 V

S1156-8		
Rated voltage		230V 3 ~ 50Hz
Max operating current including 0 kW immersion heater (Recommended fuse rating).	A _{rms}	14(16)
Max operating current including 0.5 kW immersion heater (Recommended fuse rating).	A _{rms}	16(16)
Max operating current including 1.5 kW immersion heater (Recommended fuse rating).	A _{rms}	20(20)
Max operating current including 2.5 kW immersion heater (Recommended fuse rating).	A _{rms}	23(25)
Max operating current including 4 kW immersion heater (Recommended fuse rating).	A _{rms}	21(25)
Max operating current including 4.5 kW immersion heater (Recommended fuse rating).	A _{rms}	25(25)
Additional power	kW	0.5/1/1.5/2/2.5/3 /3.5/4/4.5

S1156-13		
Rated voltage		230V 3 ~ 50Hz
Max operating current including 0 kW immersion heater (Recommended fuse rating).	A _{rms}	22(25)
Max operating current including 2 kW immersion heater (Recommended fuse rating).	A _{rms}	28(32)
Max operating current including 4 kW immersion heater (Recommended fuse rating).	A _{rms}	28(32)
Max operating current including 6 kW immersion heater (Recommended fuse rating).	A _{rms}	37(40)
Max operating current including 9 kW immersion heater (Recommended fuse rating).	A _{rms}	46(50)
Additional power	kW	2/4/6/9

3x400 V

S1156-8		
Rated voltage		400V 3N ~ 50Hz
Max operating current including 0 kW immersion heater (Recommended fuse rating).	A _{rms}	12(16)
Max operating current including 0.5 – 6.5 kW immersion heater (Recommended fuse rating).	A _{rms}	16(16)
Additional power	kW	0.5 – 6.5

S1156-13		
Rated voltage		400V 3N ~ 50Hz
Max operating current including 0 kW immersion heater (Recommended fuse rating).	A _{rms}	8(10)
Max operating current including 1 kW immersion heater (Recommended fuse rating).	A _{rms}	11(16)
Max operating current including 2 – 4 kW immersion heater (Recommended fuse rating).	A _{rms}	16(20)
Max operating current including 5 – 7 kW immersion heater (Recommended fuse rating).	A _{rms}	20(25)
Max operating current including 9 kW immersion heater, requires reconnection (Recommended fuse rating).	A _{rms}	22,5(25)
Additional power	kW	1 – 9

S1156-18		
Rated voltage		400V 3N ~ 50Hz
Max operating current including 0 kW immersion heater (Recommended fuse rating).	A_{rms}	10(10)
Max operating current including 1 kW immersion heater (Recommended fuse rating).	A_{rms}	13(16)
Max operating current including 2 – 4 kW immersion heater (Recommended fuse rating).	A_{rms}	18(20)
Max operating current including 5 – 7 kW immersion heater (Recommended fuse rating).	A_{rms}	22(25)
Max operating current including 9 kW immersion heater, requires reconnection (Recommended fuse rating).	A_{rms}	24(25)
Additional power	kW	1 – 9
Short circuit power (Ssc) ¹	MVA	2.35

¹ This equipment complies with IEC 61000-3-12, on the condition that the short circuit power Ssc is greater than or equal to 2.35 MVA at the connection point between the customer installation's electrical supply and the mains network. It is the responsibility of the installer or user of the equipment to ensure, through consultation with the distribution network operator if required, that the equipment is only connected to a supply with a short circuit power Ssc equal to or greater than 2.35 MVA.

The following data only applies to S1156 3x400 V. S1156 is also available with passive cooling, and in voltage versions 1x230 V and 3x230 V. Contact your NIBE dealer for more information.

Model		S1156-8	S1156-13	S1156-18
Output data according to EN 14511				
Heating capacity (P_H)	kW	1.5 - 8	3 - 13	4 - 18
0/35 nominal				
Heating capacity (P _H)	kW	2.85	5.12	6.80
Supplied power (P _E)	kW	0.56	1.01	1.33
COP		5.05	5.06	5.10
0/45 nominal				
Heating capacity (P _H)	kW	2.62	4.81	6.45
Supplied power (P _E)	kW	0.69	1.26	1.65
COP		3.80	3.81	3.91
10/35 nominal				
Heating capacity (P _H)	kW	3.84	7.07	9.32
Supplied power (P _E)	kW	0.54	0.96	1.30
COP		7.05	7.38	7.18
10/45 nominal				
Heating capacity (P _H)	kW	3.57	6.58	8.75
Supplied power (P _E)	kW	0.71	1.27	1.69
COP		5.07	5.18	5.19
SCOP according to EN 14825				
Rated heating output (P _{designh})	kW	7.5	11	15.1
SCOP cold climate, 35 °C / 55 °C		5.95 / 4.44	6.13 / 4.46	6.22 / 4.60
SCOP average climate, 35 °C / 55 °C		5.67 / 4.26	5.88 / 4.29	5.94 / 4.42
Energy rating, average climate				
The product's room heating efficiency class 35 °C / 55 °C ¹		A+++ / A+++	A+++ / A+++	A+++ / A+++
The system's room heating efficiency class 35 °C / 55 °C ²		A+++ / A+++	A+++ / A+++	A+++ / A+++
Efficiency class hot water heating / declared tap profile with water heater ³		A+ / XL VPB S300	A+ / XL VPB S300	A+ / XXL VPB S300
Noise				
Sound power level (L _{WA}) _{EN 12102} at 0/35	dB(A)	36 - 43	36 - 47	36 - 47
Sound pressure level (L _{pA}) calculated values according to EN ISO 11203 at 0/35 and 1m range	dB(A)	21 - 28	21 - 32	21 - 32
Electrical data				
Output, Brine pump	W	2 - 75	2 - 180	2 - 180
Output, Heating medium pump	W	2 - 63	2 - 63	2 - 75
Enclosure class			IPX1B	
Equipment Compliant with IEC 61000-3-12				
For Connection Design Purposes, Compliant with IEC 61000-3-3 technical requirements				
WLAN				
2.412 - 2.484 GHz max power	dbm		15	
Wireless units				
2.405 - 2.480 GHz max power	dbm		5	
Refrigerant circuit				
Type of refrigerant			R454B	
GWP refrigerant			466	
Fill amount	kg	1.15	1.45	1.75
CO ₂ equivalent	ton	0.54	0.68	0.82
Brine circuit				
Min/max system pressure brine	MPa (bar)	0.05 (0.5) / 0.45 (4.5)		
Flow at P _{designh} ^{4 5}	l/s	0.43	0.67	0.68
Max external available pressure at P _{designh} ⁵	kPa	33	69	70
Min/Max incoming Brine temp	°C	see diagram		
Min. outgoing brine temp.	°C	-12		
Heating medium circuit				
Min/Max system pressure heating medium	MPa (bar)	0.05 (0.5) / 0.45 (4.5)		
Flow at P _{designh} ^{5 6}	l/s	0.18	0.27	0.36
Max external available pressure at P _{designh} ⁵	kPa	71	72	65
Min/max HM-temp	°C	see diagram		
Pipe connections				
Brine ext diam. CU pipe	mm	28	28	28
Heating medium ext diam. CU pipes	mm	22	28	28

Model		S1156-8	S1156-13	S1156-18
Connection, hot water heater ext diam	mm	22	28	28
Compressor oil				
Oil type		POE		
Oil volume	l	0.45	0.90	0.90
Dimensions and weight				
Width x Depth x Height	mm	600 x 620 x 1,500		
Ceiling height ⁷	mm	1,670		
Weight complete heat pump	kg	165	179	184
Weight only cooling module	kg	83	93.5	98.5
Part number, 1x230 V		065 694	065 708	-
Part number, 3x230 V		065 693	065 707	-
Part number, 3x400 V T		-	065 709	-
Part number, 3x400 V		065 692	065 706	065 717

1 Scale for the product's efficiency class room heating: A+++ to D.

2 Scale for the system's efficiency class room heating: A+++ to G. Reported efficiency for the system takes the product's temperature regulator into account.

3 Scale for efficiency class hot water: A+ to F.

4 For 18 kW, the value is given at Delta T=4°C, for others at Delta T=3°C

5 Brine in 0°C / Water out 45°C²

6 At Delta T=10°C

7 With feet removed, the height is approx. 1,650 mm.

WORKING RANGE HEAT PUMP, COMPRESSOR OPERATION

The compressor provides a supply temperature up to 65 °C at -5 °C incoming brine temperature.

The compressor's speed is limited in certain parts of the working range.

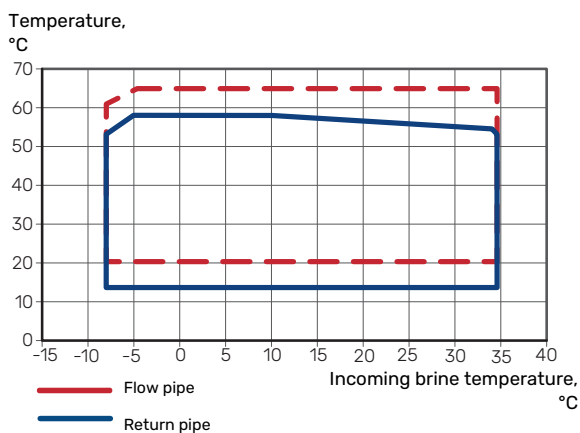

DIAGRAM, DIMENSIONING COMPRESSOR SPEED

Heating operation 35 °C and 55 °C

Diagram for dimensioning a heat pump.

S1156-8

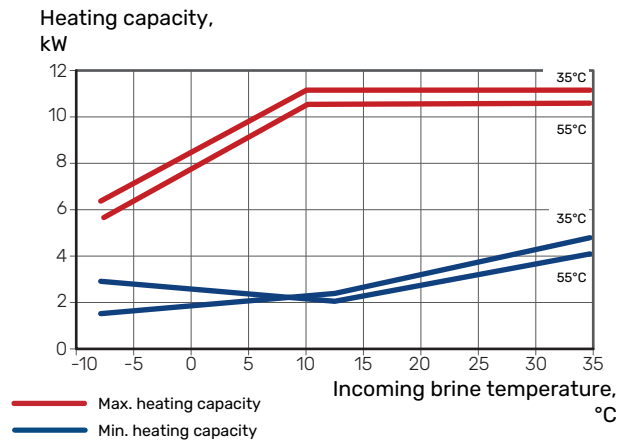

S1156-13

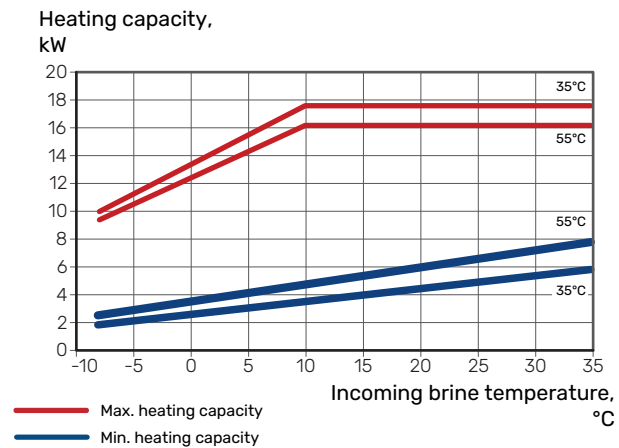

S1156-18

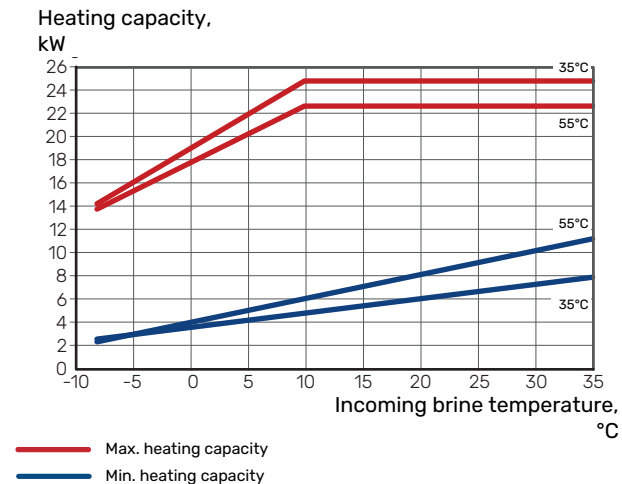

Cooling operation (accessories are required)

To dimension heating dump, see the diagram for heating operation.

Cooling capacity at supply temperature 35 °C and 55 °C

S1156-8

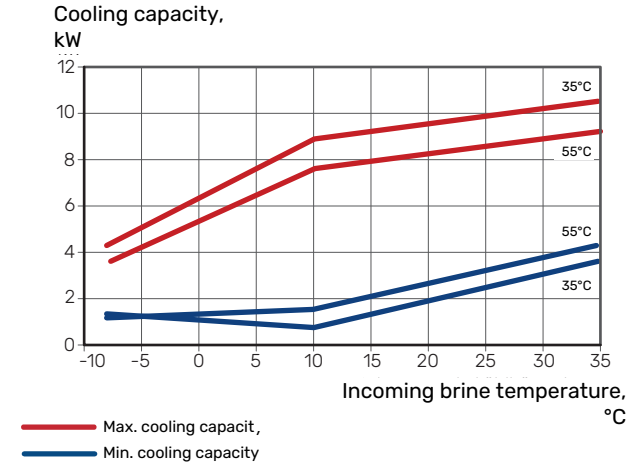

S1156-13

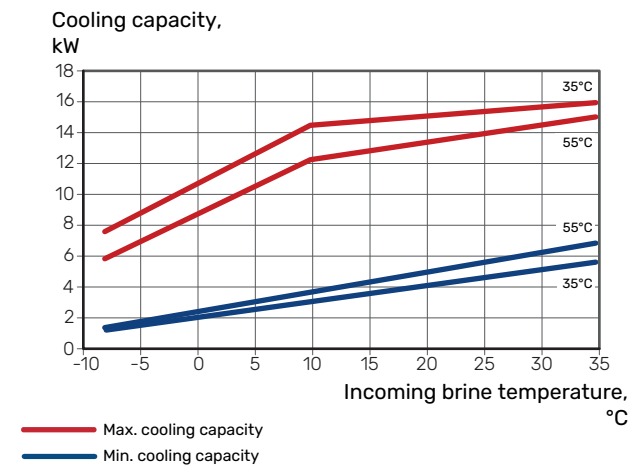

S1156-18

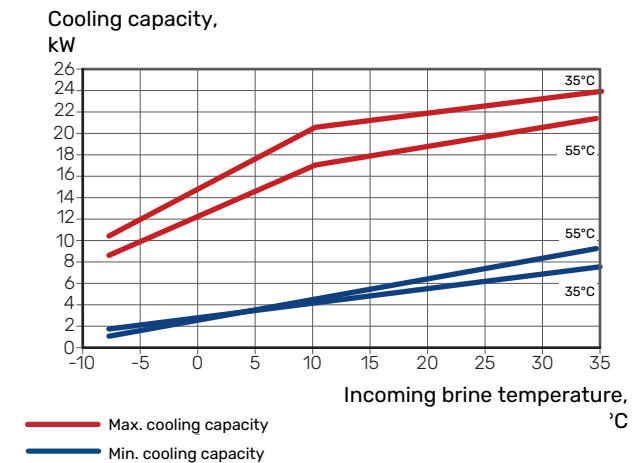

PUMP CAPACITY DIAGRAM

Brine side

To set the correct flow in the brine system, the brine pump must run at the correct speed. S1156 has a brine pump that is controlled automatically in standard mode.

For optimum operation when several heat pumps are installed in a multi-installation, all heat pumps should have the same compressor size.

— Available pressure, kPa
— Electrical output, W

S1156 8 kW

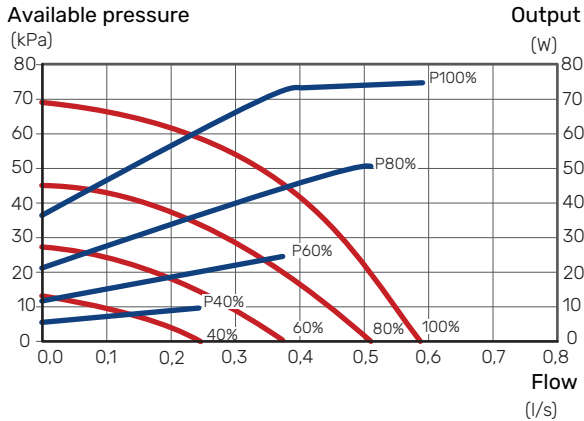

S1156 13 kW

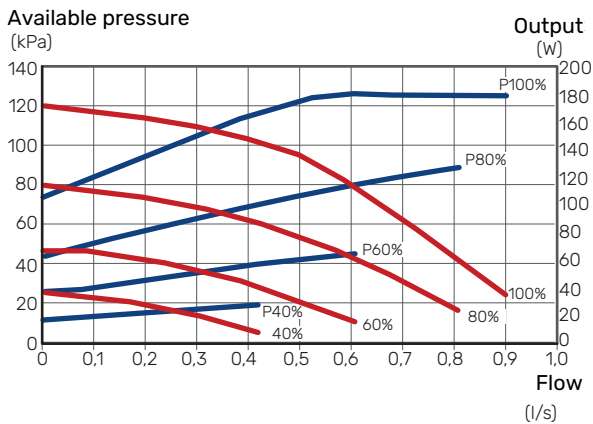

S1156 18 kW

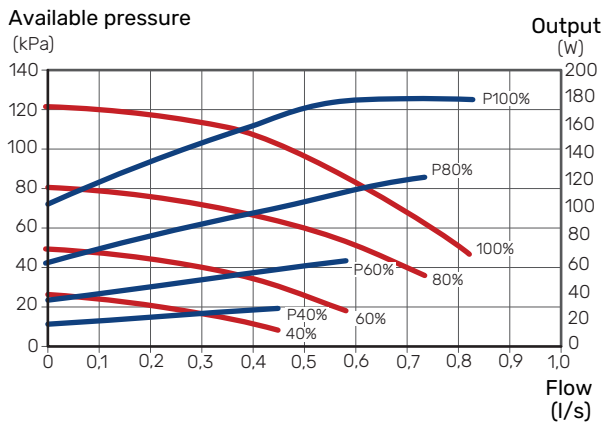

Climate system

To set the correct flow in the climate system, the heating medium pump must run at the correct speed. S1156 has a heating medium pump that can be automatically controlled in standard mode.

— Available pressure, kPa
— Electrical output, W

S1156 8 kW

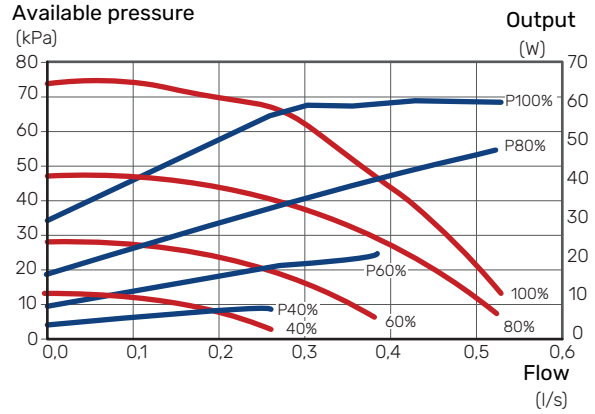

S1156 13 kW

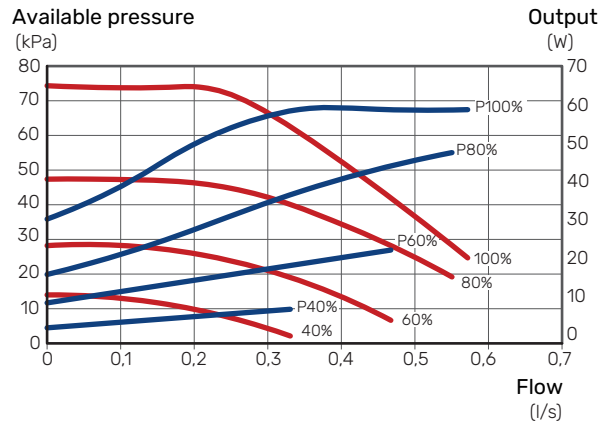

S1156 18 kW

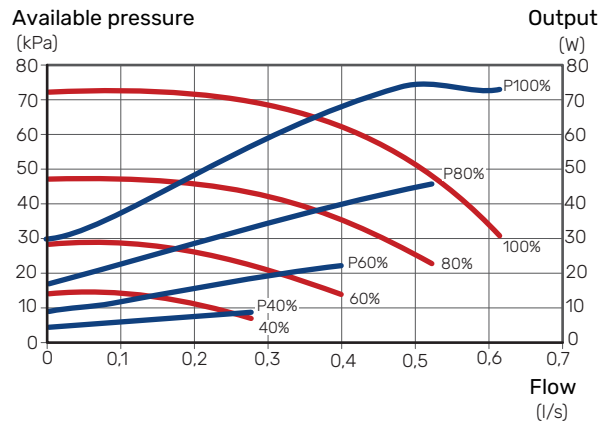

Accessories

Not all accessories are available on all markets.

Detailed information about the accessories and complete accessories list available at nibe.eu.

ACTIVE/PASSIVE COOLING HPAC S40

The accessory HPAC S40 is a climate exchange module that is to be included in a system with S1156.

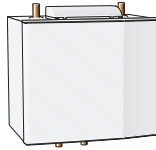

EXTRA SHUNT GROUP ECS

This accessory is used when S1156 is installed in houses with two or more different heating systems that require different supply temperatures.

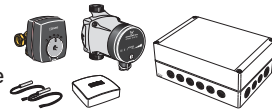

FREE COOLING PCS 44

This accessory is used when S1156 is installed in an installation with passive cooling.

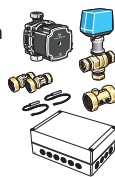

EXHAUST AIR MODULE FLM S45

FLM S45 is an exhaust air module designed to combine recovery of mechanical exhaust air with ground source heating.

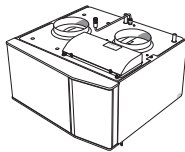

HRV UNIT ERS

This accessory is used to supply the accommodation with energy that has been recovered from the ventilation air. The unit ventilates the house and heats the supply air as necessary.



ERS 30-400¹

¹ A preheater may be required.

BASE EXTENSION EF 45

This accessory can be used to create a larger area under S1156.

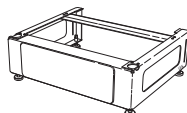

PASSIVE COOLING PCM S40/S42

PCM S40/42 makes it possible to obtain passive cooling from rock, groundwater or surface soil collectors.

Max. 17 kW.

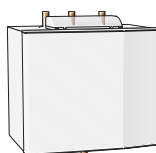

POOL HEATING POOL 40

POOL 40 is used to enable pool heating with S1156.

Max. 17 kW.

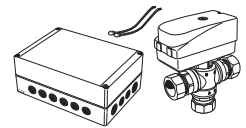

FILLING VALVE KIT, BRINE 25/32

Valve kit for filling brine in the collector hose. Includes particle filter and insulation.

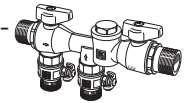

ROOM UNIT RMU S40

The room unit is an accessory with a built-in room sensor, which allows the control and monitoring of S1156 to be carried out in a different part of your home to where it is located.



ACCESSORY CARD AXC 40

This accessory is used to enable connection and control of shunt controlled additional heat, step controlled additional heat, external circulation pump or ground water pump.

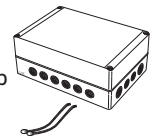

WIRELESS ACCESSORIES

It is possible to connect wireless accessories to S1156, e.g. room, humidity, CO₂ sensors.

For more information, as well as a complete list of all available wireless accessories, see myuplink.com.



WATER HEATER/ACCUMULATOR TANK

For information regarding suitable water heaters, see nibe.eu.







Sustainable energy solutions since 1952

NIBE has been manufacturing energy-efficient and sustainable climate solutions for your home for 70 years. It all began in Markaryd, in the southern Swedish province of Småland, and we recognise our Nordic heritage by utilising the power of nature. We combine renewable energy with smart technology to offer efficient solutions, allowing us to work together to create a more sustainable future.

Regardless of whether it is a chilly winter's day or a warm afternoon in the summer sun, we need a balanced indoor climate that allows us to enjoy a comfortable life, whatever the weather. Our extensive range of products supply your home with cooling, heating, ventilation and hot water, making it possible for you to create a pleasant indoor climate with little impact on the environment.

NIBE Energy Systems
Box 14, SE-285 21 Markaryd
nibe.eu



This product sheet is a publication from NIBE Energy Systems. All product illustrations, facts and data are based on current information at the time of the publication's approval. NIBE Energy Systems makes reservations for any factual or printing errors in this product sheet.