

User manual



Indoor module

NIBE VVM 310



UHB EN 2235-1
731255

Quick guide

Navigation

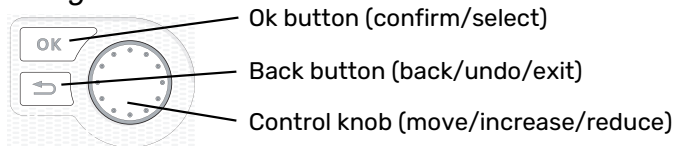

A detailed explanation of the button functions can be found on page 8.

How to scroll through menus and make different settings is described on page 10.

Set the indoor climate

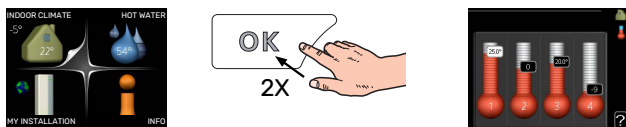

The mode for setting the indoor temperature is accessed by pressing the OK button twice, when in the start mode in the main menu. Read more about the settings on page 13.

Increase hot water volume



To temporarily increase the amount of hot water, first turn the control knob to mark menu 2 (water droplet) and then press the OK button twice. Read more about the settings on page 22.

In event of disturbances in comfort

If you experience any disturbance in comfort, there are some measures you can take yourself before you need to contact your installer. See section "Disturbances in comfort" for instructions.

Table of Contents

1	Important information _____	4
	Installation data _____	4
	Safety information _____	4
	Symbols _____	5
	Serial number _____	5
	VVM 310 – An excellent choice _____	5
2	The heating installation – the heart of the house _____	6
	Installation function _____	6
	Contact with VVM 310 _____	8
	Maintenance of VVM 310 _____	11
	Saving tips _____	12
3	VVM 310 – at your service _____	13
	Set the indoor climate _____	13
	Set the hot water capacity _____	22
	Get information _____	24
	Adjust the indoor module _____	26
4	Disturbances in comfort _____	35
	Info-menu _____	35
	Manage alarm _____	35
	Troubleshooting _____	36
	Add. heat only _____	37
5	Technical data _____	38
6	Glossary _____	39
	Contact information _____	43

Important information

Installation data

Product	VVM 310
Serial number	
Installation date	
Installer	

No.	Name	Default settings	Set
1.1	temperature (heating curve offset)	0	
1.9.1	heating curve (curve slope)	9	
1.9.3	min. flow line temp.	20	

Accessories

Serial number must always be given.

Certification that the installation is carried out according to instructions in the accompanying installer manual and applicable regulations.

Date _____ Signed _____

Safety information

This appliance can be used by children aged from 8 years and above and persons with reduced physical, sensory or mental capabilities or lack of experience and knowledge if they have been given supervision or instruction concerning use of the appliance in a safe way and understand the hazards involved. Children shall not play with the appliance. Cleaning and user maintenance shall not be made by children without supervision.

This is an original manual. It may not be translated without the approval of NIBE. Rights to make any design or technical modifications are reserved.

©NIBE 2022.

If the supply cable is damaged, only NIBE, its service representative or similar authorised person may replace it to prevent any danger and damage.

Do not start VVM 310 if there is a risk that the water in the system has frozen.

System pressure	Max	Min
Heating medium	0.3 MPa (3 bar)	0.05 MPa (0.5 bar)
Domestic water	1.0 MPa (10 bar)	0.01 MPa (0.1 bar)

VVM 310 must be installed via an isolator switch. The cable area has to be dimensioned based on the fuse rating used.

Symbols

Explanation of symbols that may be present in this manual.



NOTE

This symbol indicates danger to person or machine.



Caution

This symbol indicates important information about what you should observe when maintaining your installation.



TIP

This symbol indicates tips on how to facilitate using the product.

Serial number

The serial number can be found at the bottom right of the front cover, in the info menu (menu 3.1) and on the type plate.

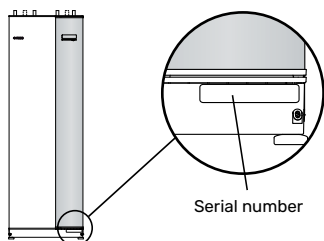

Caution

You need the product's (14 digit) serial number for servicing and support.

VVM 310 – An excellent choice

VVM 310 is an indoor module, which has been developed to supply your home with inexpensive and environmentally friendly heating and hot water in the most efficient manner.

The integrated hot water coil, immersion heater, circulation pumps and control system provide reliable and economical heat production.

The indoor module can be connected to an optional low temperature heat distribution system, e.g. radiators, connectors or underfloor heating. It is also prepared for connection to a number of different products and accessories, e.g. solar or other external heat source, extra water heater, swimming pool and climate systems with different temperatures.

VVM 310 is equipped with a control computer for good comfort, good economy and safe operation. Clear information about status, operating time and all temperatures in the system is shown on the large and easy to read display. This means, for example, that external unit thermometers are not necessary.

EXCELLENT PROPERTIES FOR VVM 310:

• *Coil for hot water*

There is a stainless steel hot water coil integrated in the indoor module. The water in the coil is heated by the hot water in the surrounding tank.

• *Buffer vessel*

There is a buffer vessel integrated in the indoor module that equalises the temperature of the water that is sent out in the climate system.

• *Scheduling the indoor comfort and hot water*

Heating and hot water can be scheduled for each day of the week or for longer periods (vacation).

• *Large display with user instructions*

The indoor module has a large display with easy-to-understand menus that facilitate setting a comfortable climate.

• *Easy to install*

The indoor module (VVM 310) is easy to install together with a compatible NIBE air/water heat pump. When installing together with NIBE air/water heat pump, the heat pump's values can easily be read off from the indoor module's display.

• *External heat source*

VVM 310 is prepared for easy connection to a solar panel installation and/or oil/gas/ wood fired boiler and district heating.

The heating installation – the heart of the house

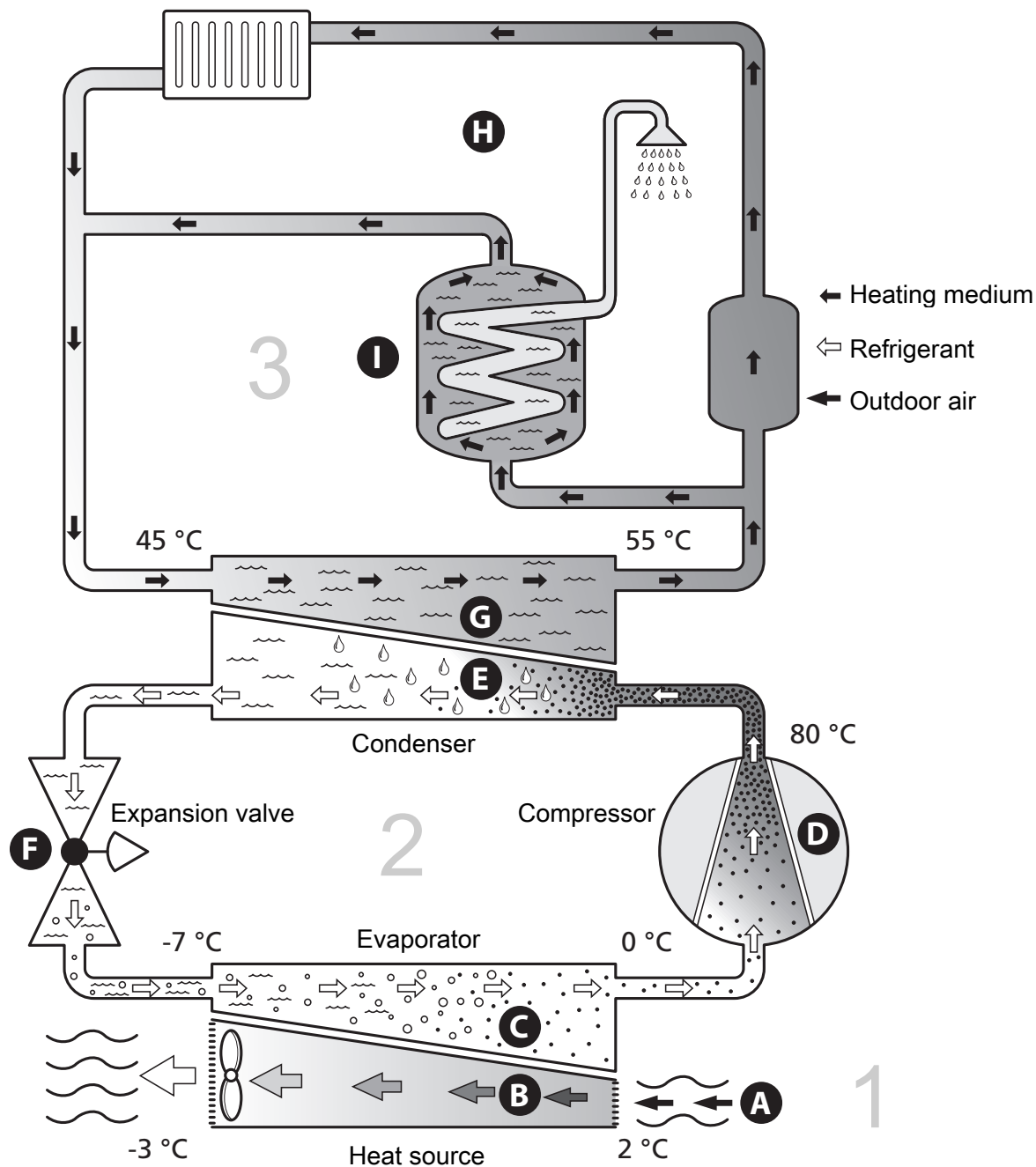

The temperatures are only examples and may vary between different installations and time of year.

Installation function

An air/water heat pump installation uses the outdoor air to heat up a home. The conversion of the outdoor air's energy into residential heating occurs in three different circuits. From the outdoor air, (1), free heat energy is retrieved and transported to the heat pump. The heat pump increases the retrieved heat's low temperature to a high temperature in the refrigerant circuit, (2). The heat is distributed around the building in the heating medium circuit, (3).

Outdoor air

- A** The outdoor air is sucked into the heat pump.
- B** The fan then routes the air to the heat pump's evaporator. Here, the air releases the heating energy to the refrigerant and the air's temperature drops. The cold air is then blown out of the heat pump.

Refrigerant circuit

- C** A gas circulates in a closed system in the heat pump, a refrigerant, which also passes the evaporator. The refrigerant has a very low boiling point. In the evaporator the refrigerant receives the heat energy from the outdoor air and starts to boil.
- D** The gas that is produced during boiling is routed into an electrically powered compressor. When the gas is compressed, the pressure increases and the gas's temperature increases considerably, from 0 °C to approx 80 °C.
- E** From the compressor, gas is forced into a heat exchanger, condenser, where it releases heat energy to the indoor module, whereupon the gas is cooled and condenses to a liquid form again.
- F** As the pressure is still high, the refrigerant can pass an expansion valve, where the pressure drops so that the refrigerant returns to its original temperature. The refrigerant has now completed a full cycle. It is routed to the evaporator again and the process is repeated.

Heat medium circuit

- G** The heat energy that the refrigerant produces in the condenser is retrieved by the indoor module's water, the heating medium, which is heated to 55 °C (supply temperature).
- H** The heating medium circulates in a closed system and transports the heated water's heat energy to the house radiators/heating coils.
- I** The indoor module's integrated hot water heater is in the boiler section. The hot boiler water heats the hot water.

Contact with VVM 310

EXTERNAL INFORMATION

When the indoor module door is closed, information can be received via an information window and a status lamp.

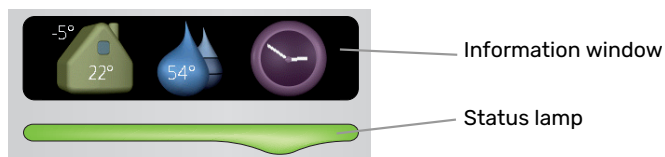

Information window

The information window shows part of the display that is on the display unit (located behind the door to the indoor module). The information window can display different types of information, e.g. temperatures, clock, etc.

You determine what is to be displayed in the information window. Your own combination of information is entered using the display unit. This information is specific to the information window and disappears when the front hatch of the indoor module door is opened.

Status lamp

The status lamp indicates the status of the indoor module: continuous green light during normal function, continuous yellow light during activated emergency mode or continuous red light in the event of a deployed alarm.

Alarm management is described on page 35.

DISPLAY UNIT

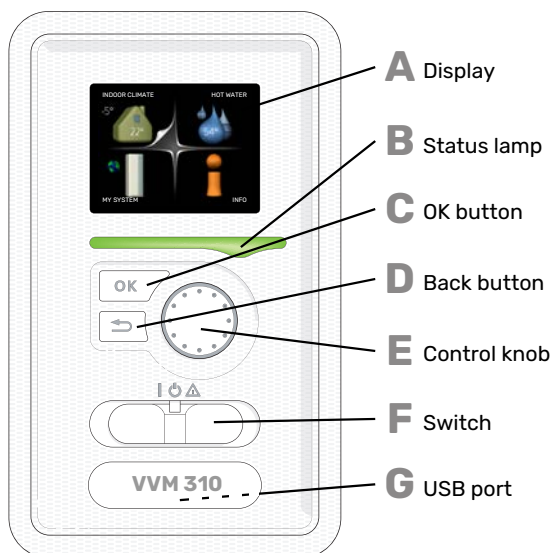

There is a display unit behind the indoor module door, which is used to communicate with VVM 310. Here you:

- switch on, switch off or set the installation to emergency mode.
- set the indoor climate and hot water as well as adjust the installation to your needs.
- receive information about settings, status and events.
- see different types of alarms and receive instructions about how they are to be rectified.

A Display

Instructions, settings and operational information are shown on the display. You can easily navigate between the different menus and options to set the comfort or obtain the information you require.

B Status lamp

The status lamp indicates the status of the indoor module. It:

- lights green during normal operation.
- lights yellow in emergency mode.
- lights red in the event of a deployed alarm.

C OK button

The OK button is used to:

- confirm selections of sub menus/options/set values/page in the start guide.

D Back button

The back button is used to:

- go back to the previous menu.
- change a setting that has not been confirmed.

E Control knob

The control knob can be turned to the right or left. You can:

- scroll in menus and between options.
- increase and decrease the values.
- change page in multiple page instructions (for example help text and service info).

F Switch

The switch assumes three positions:

- On (I)
- Standby (⏻)
- Emergency mode (⚠)

Emergency mode must only be used in the event of a fault on the indoor module. In this mode, the compressor switches off and the immersion heater engages. The indoor module display is not illuminated and the status lamp illuminates yellow.

G USB port

The USB port is hidden beneath the plastic badge with the product name on it.

The USB port is used to update the software.

Visit nibeuplink.com and click the "Software" tab to download the latest software for your installation.

MENU SYSTEM

When the door to the indoor module is opened, the menu system's four main menus are shown in the display as well as certain basic information.

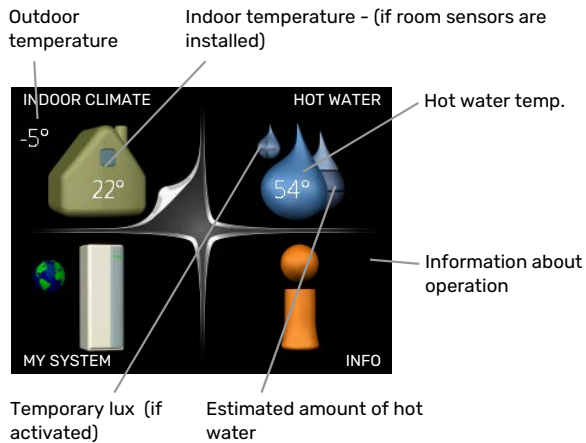

MENU 1 - INDOOR CLIMATE

Setting and scheduling the indoor climate. See page 13.

MENU 2 - HOT WATER

Setting and scheduling hot water production. See page 22.

MENU 3 - INFO

Display of temperature and other operating information and access to the alarm log. See page 24.

MENU 4 - MY SYSTEM

Setting time, date, language, display, operating mode etc. See page 26.

Symbols in the display

The following symbols can appear in the display during operation.

Symbol	Description
	This symbol appears by the information sign if there is information in menu 3.1 that you should note.
	These two symbols indicate whether the compressor in the outdoor module or additional heat is blocked in VVM 310. These can, for example, be blocked depending on which operating mode is selected in menu 4.2, if blocking is scheduled in menu 4.9.5 or if an alarm has occurred that blocks one of them. Blocking the compressor. Blocking additional heat.
	This symbol appears if periodic increase or lux mode for the hot water is activated.
	This symbol indicates whether "holiday setting" is active in 4.7.
	This symbol indicates whether VVM 310 has contact with NIBE Uplink.
	This symbol indicates the actual speed of the fan if the speed has changed from the normal setting. Accessory needed.
	This symbol is visible in installations with active solar accessories.
	This symbol indicates whether pool heating is active. Accessory needed.
	This symbol indicates whether cooling is active. Heat pump with cooling function required.

Operation

To move the cursor, turn the control knob to the left or the right. The marked position is white and/or has a turned up tab.





Selecting menu

To advance in the menu system select a main menu by marking it and then pressing the OK button. A new window then opens with sub menus.

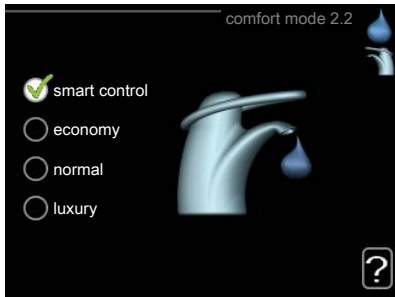

Select one of the sub menus by marking it and then pressing the OK button.

Selecting options



In an options menu the current selected option is indicated by a green tick. 

To select another option:





1. Mark the applicable option. One of the options is pre-selected (white). 
2. Press the OK button to confirm the selected option. The selected option has a green tick. 

Setting a value



Values to be changed

To set a value:

1. Mark the value you want to set using the control knob. 
2. Press the OK button. The background of the value becomes green, which means that you have accessed the setting mode. 
3. Turn the control knob to the right to increase the value and to the left to reduce the value. 
4. Press the OK button to confirm the value you have set. To change and return to the original value, press the Back button. 

Use the virtual keyboard

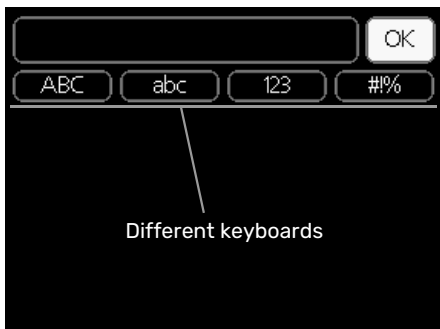

In some menus where text may require entering, a virtual keyboard is available.

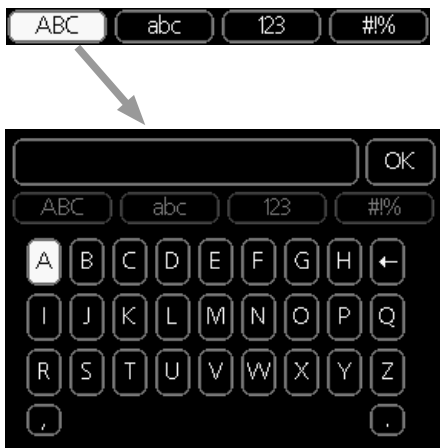

Depending on the menu, you can gain access to different character sets which you can select using the control knob. To change character table, press the Back button. If a menu only has one character set the keyboard is displayed directly. When you have finished writing, mark "OK" and press the OK button.

Scroll through the windows

A menu can consist of several windows. Turn the control knob to scroll between the windows.

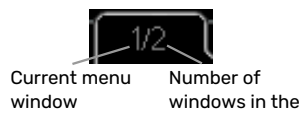

Scroll through the windows in the start guide



Arrows to scroll through window in start guide

1. Turn the control knob until one of the arrows in the top left corner (at the page number) has been marked.
2. Press the OK button to skip between the steps in the start guide.

Help menu

 In many menus there is a symbol that indicates that extra help is available.

To access the help text:

1. Use the control knob to select the help symbol.
2. Press the OK button.

The help text often consists of several windows that you can scroll between using the control knob.

Maintenance of VVM 310

REGULAR CHECKS

Your indoor module is, in principle, maintenance free and therefore requires minimal care after commissioning. On the other hand, it is recommended that you check your installation regularly.

If anything abnormal occurs, messages about the malfunction appear in the display in the form of various alarm texts. See alarm management in section "Alarm".

Safety valve

The hot water coil's externally mounted safety valve sometimes releases water after hot water usage. This is because the cold water that enters the hot water coil expands when heated, causing the pressure to rise and the safety valve to open. The climate system's externally fitted safety valve must be completely sealed and normally does not release any water.

The function of the safety valve should be checked regularly. You can find the safety valve on the incoming pipe (cold water). Perform checks as follows:

1. Open the valve.
2. Check that water flows through the valve.
3. Close the valve.
4. Check the system pressure, top up if required.



TIP

The safety valve is not supplied with the indoor module. Contact your installer if you are unsure how one checks the valve.

Check pressure

VVM 310 must be fitted with an external pressure gauge, which shows the heating system pressure. The pressure should be between 0.5 and 1.5 bar, but varies during temperature changes. If the pressure drops to 0 or rises to 2.5 bar frequently, contact your installer for troubleshooting.

Filling the climate system

If the pressure is too low in the climate system, it needs to be topped up. See the Installer Manual for more information.

Venting the climate system

In event of repeated filling of the climate system, or if bubbling sounds are heard from the indoor module, the system may need venting. This is done as follows:

1. Turn off the power supply to the indoor module.
2. Vent the indoor module via the vent valves and the rest of the climate system via the relevant vent valves.
3. Keep topping up and venting until all air has been removed and the pressure is correct.

The climate system may require topping up after venting.

Saving tips

Your installation produces heat and hot water. This occurs via the control settings you made.

Factors that affect the energy consumption are, for example, indoor temperature, hot water consumption, the insulation level of the house and whether the house has many large window surfaces. The position of the house, e.g. wind exposure is also an affecting factor.

Also remember:

- Open the thermostat valves completely (except in rooms where you want it to be cooler). This is important, as fully or partially closed thermostat valves slow the flow in the climate system, which results in VVM 310 working at a higher temperature. This in turn can lead to increased energy consumption.
- You can lower the operating cost when away from home by scheduling selected parts of the system. This is done in menu 4.7 "holiday setting". See page 32 for instructions.
- If you activate "economy" in menu 2.2 "comfort mode", less energy is used.
- You can influence the energy consumption by connecting the indoor module to different supplements such as solar, gas or oil.

POWER CONSUMPTION

Approximate energy consumption for VVM 310 spread across the year

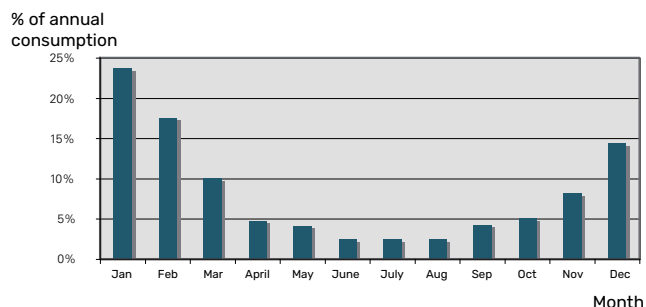

Increasing the indoor temperature by one degree increases the energy consumption by approx. 5 %.

Energy meter

Check the accommodation's energy meter regularly, preferably once a month. This will indicate any changes in power consumption.

Newly built houses usually have twin energy meters, use the difference to calculate your domestic electricity.

New builds

Newly built houses undergo a drying out process for a year. The house can then consume significantly more energy than it would thereafter. After 1-2 years the heating curve should be adjusted again, as well as the offset heating curve and the building's thermostat valves, because the heating system, as a rule, requires a lower temperature once the drying process is complete.

VVM 310 – at your service

Set the indoor climate

OVERVIEW

Sub-menus

For the menu **IN-DOOR CLIMATE** there are several sub-menus. Status information for the relevant menu can be found on the display to the right of the menus.

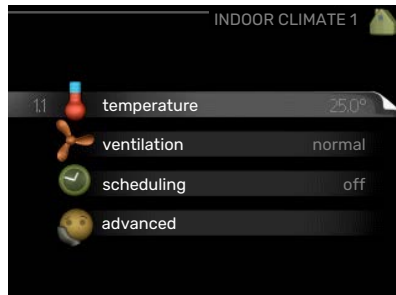

temperature Setting the temperature for the climate system. The status information shows the set values for the climate system.

ventilation Setting the fan speed. The status information shows the selected setting. This menu is only displayed if the exhaust air module is connected (accessory).

scheduling Scheduling heating, cooling and ventilation. Status information "set" is displayed if you set a schedule but it is not active now, "holiday setting" is displayed if the vacation schedule is active at the same time as the schedule (the vacation function is prioritised), "active" displays if any part of the schedule is active, otherwise it displays " off".

advanced Setting of heat curve, adjusting with external contact, minimum value for supply temperature, room sensor, cooling function and +Adjust.

MENU 1.1 - TEMPERATURE

If the house has several climate systems, this is indicated on the display by a thermometer for each system.

Choose between heating or cooling and then set the desired temperature in the next menu "temperature heating/cooling" in menu 1.1.

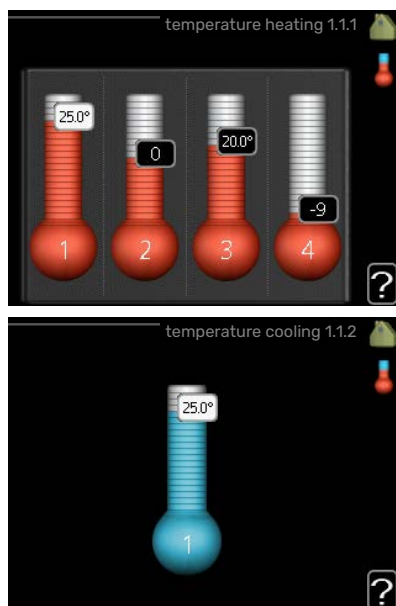

Set the temperature (with room sensor installed and activated):

heating

Setting range: 5 – 30 °C

Default value: 20

cooling (accessory required)

Setting range: 5 – 30 °C

Default value: 25

The value in the display appears as a temperature in °C if the climate system is controlled by a room sensor.

Caution

A slow heating system such as underfloor heating may not be suitable for control using the indoor module's room sensors.

To change the room temperature, use the control knob to set the desired temperature in the display. Confirm the new setting by pressing the OK button. The new temperature is shown on the right-hand side of the symbol in the display.

Setting the temperature (without room sensors activated):

Setting range: -10 to +10

Default value: 0

The display shows the set values for heating (curve offset). To raise or lower the indoor temperature, increase or reduce the value on the display.

Use the control knob to set a new value. Confirm the new setting by pressing the OK button.

The number of steps the value has to be changed to achieve a degree change of the indoor temperature depends on the heating installation. One step is usually enough but in some cases several steps may be required.

Setting the desired value. The new value is shown on the right-hand side of the symbol in the display.

Setting the relative humidity: (accessory is required)

Setting range: 30 to 90 %

Factory setting: 60 %

The menu is only displayed if limit RH is activated in menu 5.3.16.

The display shows the value set for relative humidity. To change how VVM 310 is run, in relation to relative humidity, increase or decrease the value given on the display.

Use the control knob to set the required value. Confirm the new setting, by pressing the OK button.

Caution

An increase in the room temperature can be slowed by the thermostats for the radiators or under floor heating. Therefore, open the thermostats fully, except in those rooms where a cooler temperature is required, e.g. bedrooms.

TIP

Wait 24 hours before making a new setting, so that the room temperature has time to stabilise.

If it is cold outdoors and the room temperature is too low, increase the curve slope in menu 1.9.1.1 by one increment.

If it is cold outdoors and the room temperature is too high, reduce the curve slope in menu 1.9.1.1 by one increment.

If it is warm outdoors and the room temperature is too low, increase the value in menu 1.1.1 by one increment.

If it is warm outdoors and the room temperature is too high, reduce the value in menu 1.1.1 by one increment.

MENU 1.2 - VENTILATION (ACCESSORY REQUIRED)

Setting range: normal and speed 1-4
Default value: normal

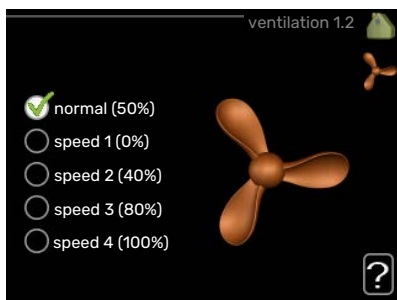

The ventilation in the accommodation can be temporarily increased or reduced here.

When you have selected a new speed a clock starts a count down. When the time has counted down the ventilation speed returns to the normal setting.

If necessary, the different return times can be changed in menu 1.9.6.

The fan speed is shown in brackets (in percent) after each speed alternative.

TIP

If longer time changes are required use the holiday function or scheduling.

Caution

The ventilation accessory requires a minimum ventilation flow in order to work properly. An insufficient ventilation flow can result in an alarm and blocking of compressor operation.

MENU 1.3 - SCHEDULING

In the menu **scheduling** indoor climate (heating/cooling/ventilation) is scheduled for each weekday.

You can also schedule a longer time during a selected period (holiday) in menu 4.7.

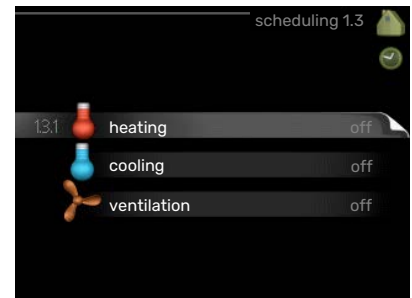

MENU 1.3.1 - HEATING

Increases or decreases in the accommodation temperature can be scheduled here for up to three time periods per day. If a room sensor is installed and activated the desired room temperature (°C) is set during the time period. Without an activated room sensor the desired change is set (of setting in menu 1.1). One step is usually enough to change the room temperature by one degree, but in some cases several steps may be required.

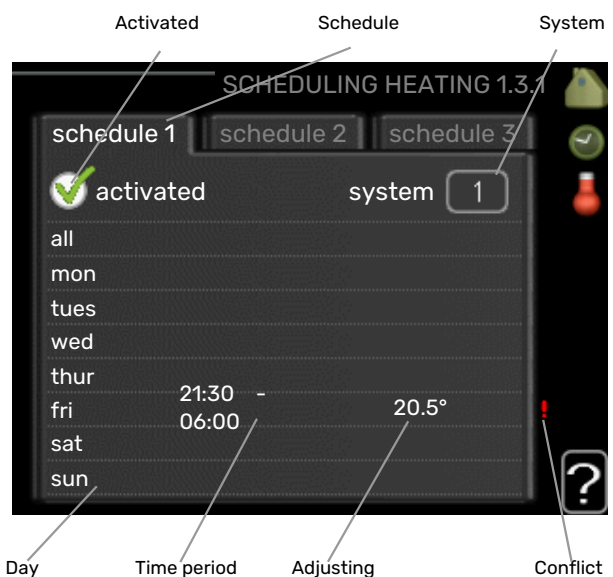

Schedule: The schedule to be changed is selected here.

Activated: Scheduling for the selected period is activated here. Set times are not affected at deactivation.

System: The climate system that the relevant schedule relates to is selected here. This alternative is only displayed if there is more than one climate system.

Day: Select which day or days of the week the scheduling is to apply to here. To remove the scheduling for a particular day, the time for that day must be reset by setting the start time to the same as the stop time. If the row "all" is used, all days in the period are set according to that row.

Time period: The start and stop time for the selected day for scheduling are selected here.

Adjustment: How much the heating curve is to be offset in relation to menu 1.1 during scheduling is set here. If a room sensor is installed, the desired room temperature is set in °C.

Conflict: If two settings conflict with each other, a red exclamation mark is displayed.

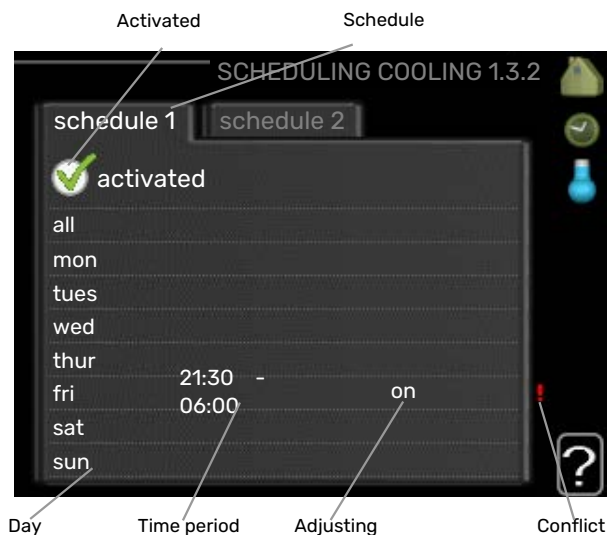

Schedule: The schedule to be changed is selected here.

Activated: Scheduling for the selected period is activated here. Set times are not affected at deactivation.

Day: Select which day or days of the week the scheduling is to apply to here. To remove the scheduling for a particular day, the time for that day must be reset by setting the start time to the same as the stop time. If the row "all" is used, all days in the period are set according to that row.

Time period: The start and stop time for the selected day for scheduling are selected here.

Adjustment: Here, you schedule when cooling will not be permitted.

Conflict: If two settings conflict with each other, a red exclamation mark is displayed.



TIP

If you wish to set similar scheduling for every day of the week start by filling in "all" and then changing the desired days.



TIP

Set the stop time earlier than the start time so that the period extends beyond midnight. Scheduling then stops at the set stop time the day after.

Scheduling always starts on the date that the start time is set for.



Caution

Changes of temperature in accommodation take time. For example, short time periods in combination with underfloor heating will not give a noticeable difference in room temperature.



TIP

If you wish to set similar scheduling for every day of the week start by filling in "all" and then changing the desired days.



TIP

Set the stop time earlier than the start time so that the period extends beyond midnight. Scheduling then stops at the set stop time the day after.

Scheduling always starts on the date that the start time is set for.

MENU 1.3.2 - COOLING (ACCESSORY REQUIRED)

Here you can schedule when cooling is permitted in the accommodation for up to two different time periods per day.

MENU 1.3.3 - VENTILATION (ACCESSORY REQUIRED)

Increases or decreases in the ventilation to the accommodation can be scheduled here for up to two time periods per day.

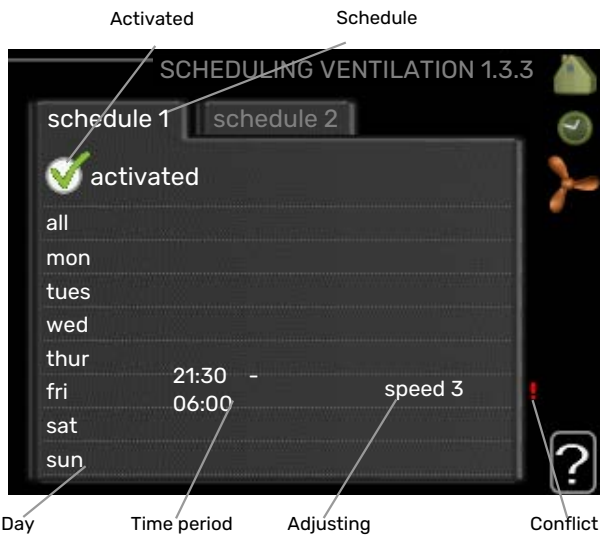

Schedule: The schedule to be changed is selected here.

Activated: Scheduling for the selected period is activated here. Set times are not affected at deactivation.

Day: Select which day or days of the week the scheduling is to apply to here. To remove the scheduling for a particular day, the time for that day must be reset by setting the start time to the same as the stop time. If the row "all" is used, all days in the period are set according to that row.

Time period: The start and stop time for the selected day for scheduling are selected here.

Adjustment: The desired fan speed is set here.

Conflict: If two settings conflict with each other, a red exclamation mark is displayed.



TIP

If you wish to set similar scheduling for every day of the week start by filling in "all" and then changing the desired days.



TIP

Set the stop time earlier than the start time so that the period extends beyond midnight. Scheduling then stops at the set stop time the day after.

Scheduling always starts on the date that the start time is set for.



Caution

A significant change over a longer period of time may cause poor indoor environment and worse operating economy.

MENU 1.9 - ADVANCED

Menu **advanced** has orange text and is intended for the advanced user. This menu has several sub-menus.

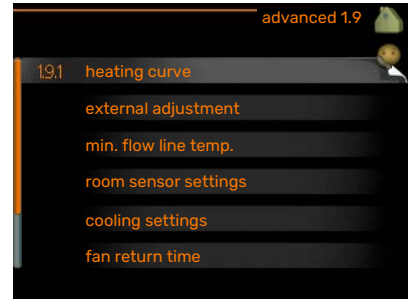

curve Setting the curve slope for heating and cooling.

external adjustment Setting the heat curve offset when the external contact is connected.

min. flow line temp. Setting minimum permitted flow line temperature.

room sensor settings Settings regarding the room sensor.

cooling settings Settings for cooling.

fan return time Fan return time settings in the event of temporary ventilation speed change.

own curve Setting own curve for heating and cooling.

point offset Setting the offset of the heating curve or cooling curve at a specific outdoor temperature.

night cooling Setting night cooling.

+Adjust Setting how much effect +Adjust will have on calculated supply temperature for underfloor heating. The higher the value is the greater the effect.

MENU 1.9.1 - CURVE

heating curve

Setting range: 0 - 15

Default value: 9

cooling curve

Setting range: 0 - 9

Default value: 0

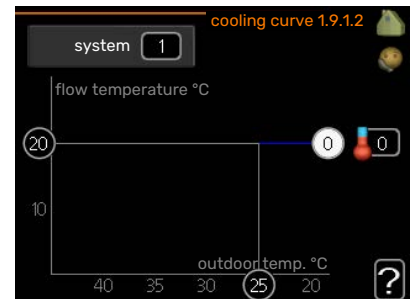
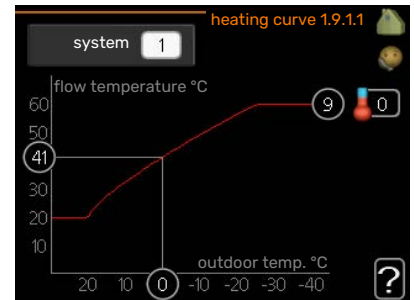

The prescribed heating curve for your house can be viewed in the menu **curve**. The task of the heating curve is to give an even indoor temperature, regardless of the outdoor temperature, and thereby energy efficient operation. It is from this heating curve that the indoor module's control computer determines the temperature of the water to the

heating system, supply temperature, and therefore the indoor temperature. Select the heating curve and read off how the supply temperature changes at different outdoor temperatures here. If there is access to cooling the same settings can be made for the cooling curve.



Caution

With underfloor heating systems, **max flow line temperature** should normally be set to between 35 and 45 °C.

With underfloor cooling, "min. flow line temp." must be restricted to prevent condensation.

Check the max temperature for your floor with your installer/floor supplier.



TIP

Wait 24 hours before making a new setting, so that the room temperature has time to stabilise.

If it is cold outdoors and the room temperature is too low, increase the curve slope by one increment.

If it is cold outdoors and the room temperature is too high, lower the curve slope by one increment.

If it is warm outdoors and the room temperature is too low, increase the curve offset by one increment.

If it is warm outdoors and the room temperature is too high, lower the curve offset by one increment.

Cooling in 2-pipe system

VVM 310 contains a built-in function for operating cooling in a 2-pipe system down to 17 °C, factory setting 18 °C. This requires that the outdoor unit can perform cooling. (See the Installer Manual for your air/water heat pump.) If the outdoor unit can perform cooling, the cooling menus are activated in the display on the indoor module (VVM).

In order for operating mode "cooling" to be permitted, the average temperature must be above the setting value for "start cooling" in menu 4.9.2

The cooling settings for the climate system are adjusted in the indoor climate menu, menu 1.

MENU 1.9.2 - EXTERNAL ADJUSTMENT

Set the temperature (with room sensor installed and activated):

Setting range: 5 – 30 °C

Default value: 20

Setting the temperature (without room sensors activated):

Setting range: -10 to +10.

Default value: 0

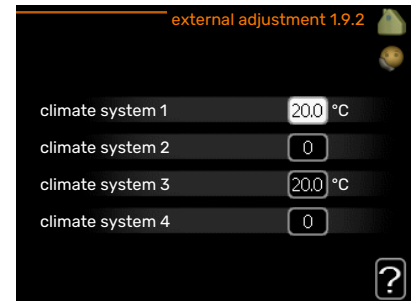

Connecting an external contact, for example, a room thermostat or a timer allows you to temporarily or periodically raise or lower the room temperature while heating. When the contact is on, the heating curve offset is changed by the number of steps selected in the menu. If a room sensor is installed and activated the desired room temperature (°C) is set.

If there is more than one climate system the setting can be made separately for each system.

MENU 1.9.3 - MIN. FLOW LINE TEMP.

heating

Setting range: 5-70 °C

Default value: 20 °C

cooling (accessory required)

Factory setting: 18 °C

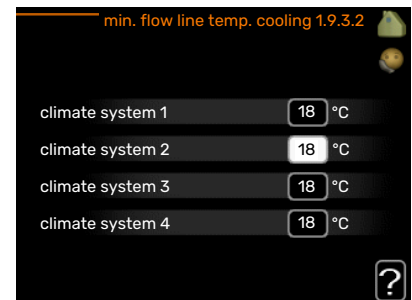
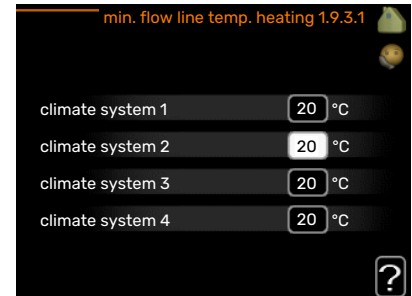

In menu 1.9.3 you select heating or cooling, in the next menu (min. supply temp.heating/cooling) set the minimum temperature on the supply temperature to the climate system. This means that VVM 310 never calculates a temperature lower than that set here.

If there is more than one climate system the setting can be made separately for each system.



TIP

The value can be increased if you have, for example, a cellar that you always want to heat, even in summer.

You may also need to increase the value in "stop heating" menu 4.9.2 "auto mode setting".

MENU 1.9.4 - ROOM SENSOR SETTINGS

factor system

heating

Setting range: 0.0 - 6.0

Factory setting heating: 1.0

cooling (accessory required)

Setting range: 0.0 - 6.0

Factory setting cooling: 1.0

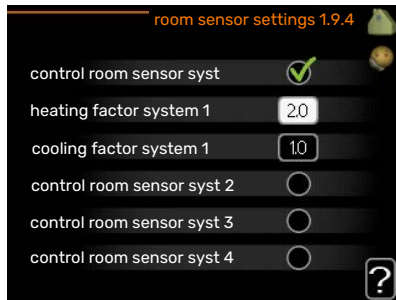

Room sensors to control the room temperature can be activated here.



Caution

A slow heating system such as underfloor heating may not be suitable for control using the installation's room sensors.

Here you can set a factor (a numerical value) that determines how much an over or sub normal temperature (the difference between the desired and actual room temperature) in the room is to affect the supply temperature to the climate system. A higher value gives a greater and faster change of the heating curve's set offset.



NOTE

Too high a set value for "factor system" can (depending on your climate system) produce an unstable room temperature.

If several climate systems are installed the above settings can be made for the relevant systems.

MENU 1.9.5 - COOLING SETTINGS (ACCESSORY REQUIRED)

delta at +20 °C

Setting range: 3 - 10 °C

Default value: 3

delta at +40 °C

Setting range: 3 - 10 °C

Default value: 6

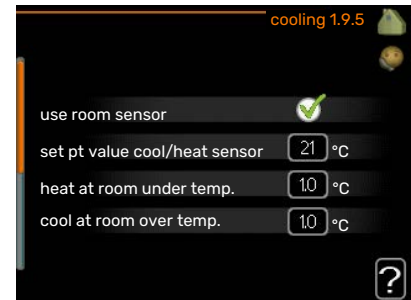

cool/heat sensor

Factory setting: no sensor selected

set pt value cool/heat sensor

Setting range: 5 - 40 °C

Default value: 21

heat at room under temp.

Setting range: 0.5 - 10.0 °C

Default value: 1.0

cool at room over temp.

Setting range: 0.5 - 10.0 °C

Default value: 1.0

alarm rumsgivare kyla

Setting range: on/off

Factory setting: off

start active cooling

Setting range: 10 - 300

Default value: 0

degree minutes cooling

Setting range: -3000 - 3000 cooling degree minutes

Factory setting: 0

time betw. switch heat/cool (Displayed if cooling in 2-pipe system is activated.)

Setting range: 0 - 48 h

Factory setting: 2

op mode auto EQ1-GP12

Here, you set whether you want the cooling pump (GP12) to run in operating mode auto.

cooling pump speed

Setting range: 1 - 100 %

Factory setting: 70 %

You can use VVM 310 to cool the house during hot periods of the year.

Caution

Certain setting options only appear if their function is installed and activated in VVM 310.

delta at +20 °C

Set the desired temperature on the temperature difference between supply and return lines to the climate system during cooling operation when the outdoor temperature is +20 °C. VVM 310 then attempts to get as close to the set temperature as possible.

delta at +40 °C

Set the desired temperature on the temperature difference between supply and return lines to the climate system during cooling operation when the outdoor temperature is +40 °C. VVM 310 then attempts to get as close to the set temperature as possible.

use room sensor

Here you can set whether room temperature sensors are to be used in cooling mode.

cool/heat sensor

An extra temperature sensor can be connected to VVM 310 in order to determine when it is time to switch between heating and cooling operation.

When several heating/cooling sensors are installed, you can select which one of them should be in control.

Caution

When the heating/cooling sensors BT74 have been connected and activated in menu 5.4, no other sensor can be selected in menu 1.9.5.

set pt value cool/heat sensor

Caution

This setting option only appears if a room sensor for cooling/heating is installed and activated in VVM 310.

Here you can set at which indoor temperature VVM 310 is to shift between heating respectively cooling operation.

heat at room under temp.

Caution

This setting option only appears if a room temperature sensor is connected to VVM 310 and has been activated.

Here you can set how far the room temperature can drop below the desired temperature before VVM 310 switches to heating operation.

cool at room over temp.

Caution

This setting option only appears if a room temperature sensor is connected to VVM 310 and has been activated.

Here you can set how high the room temperature can increase above the desired temperature before VVM 310 switches to cooling operation.

alarm rumsgivare kyla

This is where you set whether VVM 310 is to initiate an alarm if the room sensor is disconnected or breaks during cooling operation.

start active cooling

Caution

This setting option only appears if "active cooling" is activated in menu 5.2.4.

Here you can set when active cooling is to start.

Degree minutes are a measurement of the current heating demand in the house and determine when the compressor, cooling operation respectively additional heat will start/stop.

degree minutes cooling

This selection is only available when the connected accessory itself counts cooling degree minutes.

After a min or max value has been set, the system will automatically set the actual value if the air/water heat pump is running cooling.

time betw. switch heat/cool

This selection is only available when cooling in 2-pipe systems.

Here you can set how long VVM 310 is to wait before it returns to heating mode when the cooling demand has ceased or vice versa.

MENU 1.9.6 - FAN RETURN TIME (ACCESSORY REQUIRED)

speed 1-4

Setting range: 1 – 99 h

Default value: 4 h

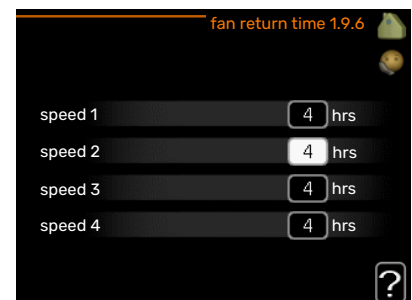

Here you select the return time for temporary speed change (speed 1-4) on the ventilation in menu 1.2.

Return time is the time it takes before ventilation speed returns to normal.

MENU 1.9.7 - OWN CURVE

supply temperature

heating
Setting range: 5 – 80 °C

cooling (accessory required)
Depending on which accessory is used the setting range can vary.
Setting range: 7 – 40 °C

own heating curve 1.9.7.1

flow line temp. at -30 °C	45 °C
flow line temp. at -20 °C	40 °C
flow line temp. at -10 °C	35 °C
flow line temp. at 0 °C	32 °C
flow line temp. at 10 °C	26 °C
flow line temp. at 20 °C	15 °C

own cooling curve 1.9.7.2

flow line temp. at 0 °C	20 °C
flow line temp. at 10 °C	20 °C
flow line temp. at 20 °C	20 °C
flow line temp. at 30 °C	20 °C
flow line temp. at 40 °C	20 °C

When required, create your own heating or cooling curve here, by setting the desired supply temperatures for different outdoor temperatures.

Caution
Curve 0 in menu 1.9.1 must be selected for own curve to apply.

MENU 1.9.8 - POINT OFFSET

outdoor temp. point
Setting range: -40 – 30 °C
Default value: 0 °C

change in curve
Setting range: -10 – 10 °C
Default value: 0 °C

point offset 1.9.8

outdoor temp. point 0 °C

change in curve 0 °C

Select a change in the heating curve at a certain outdoor temperature here. One step is usually enough to change the room temperature by one degree, but in some cases several steps may be required.

The heat curve is affected at $\pm 5^\circ\text{C}$ from set outdoor temp. point.

It is important that the correct heating curve is selected so that the room temperature is experienced as even.



TIP

If it is cold in the house, at, for example -2°C , "outdoor temp. point" is set to "-2" and "change in curve" is increased until the desired room temperature is maintained.



Caution

Wait 24 hours before making a new setting, so that the room temperature has time to stabilise.

MENU 1.9.9 - NIGHT COOLING (ACCESSORY REQUIRED)

start temp. exhaust air
Setting range: 20 – 30 °C
Default value: 25 °C

min diff.
Setting range: 3 – 10 °C
Default value: 6 °C

outdoor-exhaust
Setting range: 3 – 10 °C
Default value: 6 °C

night cooling 1.9.9

night cooling

start temp. exhaust air 25 °C

min diff. outdoor-exhaust 6 °C

Activate night cooling here.

When the temperature in the house is high and the outdoor temperature is lower, a cooling effect can be obtained by forcing the ventilation.

If the temperature difference between the exhaust air and the outdoor temperature is greater than the set value ("min diff. outdoor-exhaust"), and the exhaust air temperature is higher than the set value ("start temp. exhaust air"), run the ventilation at speed 4 until one of the conditions is no longer met.



Caution

Night cooling can only be activated when house heating has been deactivated. This is done in menu 4.2.

MENU 1.9.11 - +ADJUST

- degree of effect
Setting range: 0.1 – 1.0
Default value: 0.5

+adjust 1.9.11

- degree of effect 0.5

climate system 1

Using +Adjust, the installation communicates with the underfloor heating's control centre* and adjusts the heating curve as well as the calculated supply temperature according to the underfloor heating system.

Here you can activate the climate systems you want +Adjust to affect. You can also set how much effect +Adjust is to have on calculated supply temperature. The higher the value, the greater the effect.

*Support for +Adjust required



NOTE

+Adjust must first be selected in menu 5.4 "soft inputs/outputs".

Set the hot water capacity

OVERVIEW

Sub-menus

For the menu **HOT WATER** there are several sub-menus. Status information for the relevant menu can be found on the display to the right of the menus.



temporary lux Activation of temporary increase in the hot water temperature. Status information displays "off" or what length of time of the temporary temperature increase remains.

comfort mode Setting hot water comfort. The status information displays what mode is selected, "economy", "normal" or "luxury".

scheduling Scheduling hot water comfort. The status information "set" appears if you have set scheduling but it is not currently active, "holiday setting" appears if holiday setting is active at the same time as scheduling (when the holiday function is prioritised), "active" appears if any part of scheduling is active, otherwise "off" appears.

advanced Setting hot water circulation (accessory is required)

MENU 2.1 - TEMPORARY LUX

Setting range: 3, 6 and 12 hours and mode "off" and "one time increase"
Default value: "off"

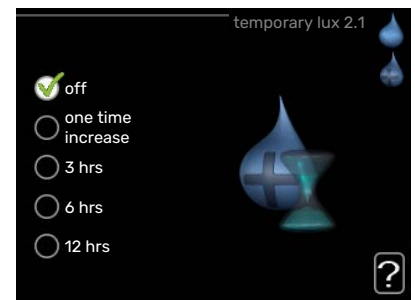

When hot water requirement has temporarily increased this menu can be used to select an increase in the hot water temperature to lux mode for a selectable time.



Caution

If comfort mode "luxury" is selected in menu 2.2 no further increase can be carried out.

The function is activated immediately when a time period is selected and confirmed using the OK button. The remaining time for the selected setting is shown to the right.

When the time has run out VVM 310 returns to the mode set in menu 2.2.

Select "off" to switch off **temporary lux**.

MENU 2.2 - COMFORT MODE

Setting range:
smart control,
economy, normal,
luxury

Factory setting:
smart control

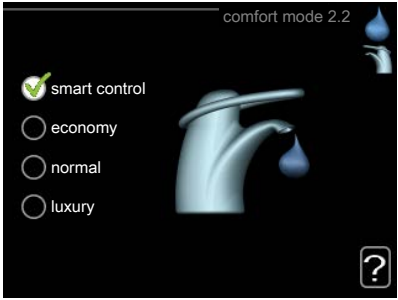

The difference between the selectable modes is the temperature of the hot tap water. Higher temperature means that the hot water lasts longer.

smart control: In this menu, you activate the Smart Control function. The function learns the previous week's hot water consumption and adapts the temperature in the water heater for the coming week to ensure minimal energy consumption.

If the hot water demand is greater, there is a certain additional amount of hot water available.

When the Smart Control function is activated, the water heater delivers the reported performance according to the energy decal.

economy: This mode produces less hot water than the others, but is more economical. This mode can be used in smaller households with a small hot water requirement.

normal: Normal mode gives a larger amount of hot water and is suitable for most households.

luxury: Lux mode gives the greatest possible amount of hot water. In this mode, the immersion heater is used to heat hot water as well as the compressor, which increases operating costs.

MENU 2.3 - SCHEDULING

What hot water comfort the indoor module is to work with can be scheduled here for up to two different time periods per day.

Scheduling is activated/deactivated by ticking/unticking "activated". Set times are not affected at deactivation.

Schedule: The schedule to be changed is selected here.

Activated: Scheduling for the selected period is activated here. Set times are not affected at deactivation.

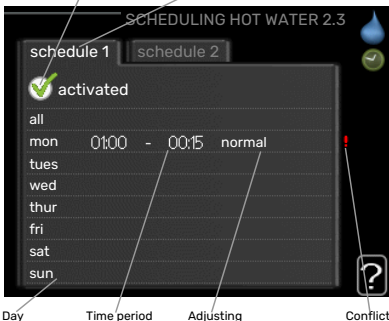

Day	Time period	Adjusting
all	01:00 - 00:15	normal
mon		
tues		
wed		
thur		
fri		
sat		
sun		

Day: Select which day or days of the week the scheduling is to apply to here. To remove the scheduling for a particular day, the time for that day must be reset by setting the start time to the same as the stop time. If the row "all" is used, all days in the period are set according to that row.

Time period: The start and stop time for the selected day for scheduling are selected here.

Adjustment: Set the hot water comfort that is to apply during scheduling here.

Conflict: If two settings conflict with each other, a red exclamation mark is displayed.



TIP

If you wish to set similar scheduling for every day of the week start by filling in "all" and then changing the desired days.



TIP

Set the stop time earlier than the start time so that the period extends beyond midnight. Scheduling then stops at the set stop time the day after.

Scheduling always starts on the date that the start time is set for.

MENU 2.9 - ADVANCED

Menu **advanced** has orange text and is intended for the advanced user. This menu has a sub-menu.

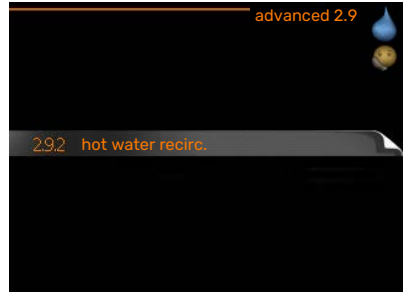

MENU 2.9.2 - HOT WATER RECIRC.

operating time

Setting range: 1 - 60 min

Default value: 60 min

downtime

Setting range: 0 - 60 min

Default value: 0 min



Set the hot water circulation for up to three periods per day here. During the set periods the hot water circulation pump will run according to the settings above.

"operating time" decide how long the hot water circulation pump must run per operating instance.

"downtime" decide how long the hot water circulation pump must be stationary between operating instances.

Get information

OVERVIEW

Sub-menus

For the menu **INFO** there are several sub-menus. No settings can be made in these menus, they just display information. Status information for the relevant menu can be found on the display to the right of the menus.

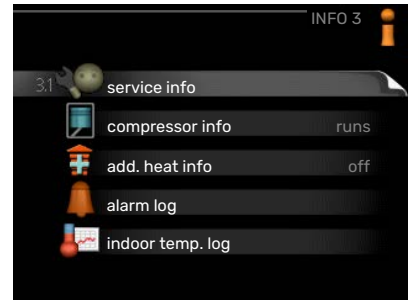

service info shows temperature levels and settings in the installation.

compressor info shows operating times, number of starts etc for the compressor in the heat pump.

add. heat info displays information about the additional heat's operating times etc.

alarm log shows the latest alarms.

indoor temp. log the average temperature indoors week by week during the past year.







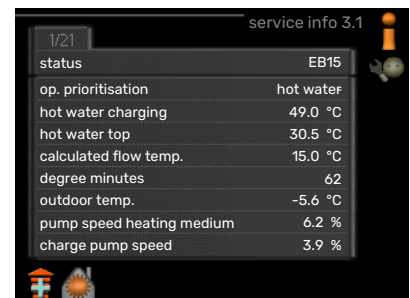

MENU 3.1 - SERVICE INFO

Information about the actual operating status of the installation (e.g. current temperatures etc.) can be obtained here. No changes can be made.

The information is on several pages. Turn the control knob to scroll between the pages.

A QR code appears on one side. This QR code indicates serial number, product name and limited operating data.



Symbols in this menu:			
	Compressor		Heating
	Addition		Hot water
	Cooling		Pool
	Heating medium pump (orange)		Ventilation
	Solar accessory		

MENU 3.2 - COMPRESSOR INFO

Information about the compressor's operating status and statistics can be obtained here. No changes can be made.

The information is on several pages. Turn the control knob to scroll between the pages.

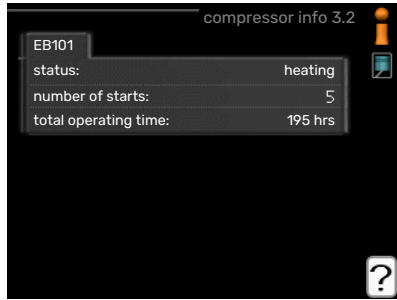

MENU 3.3 - ADD. HEAT INFO

Information about the additional heat's settings, operating status and statistics can be obtained here. No changes can be made.

The information is on several pages. Turn the control knob to scroll between the pages.

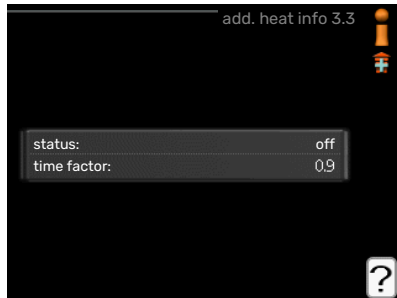

MENU 3.4 - ALARM LOG

To facilitate troubleshooting, the installation's operating status at alarm alerts is stored here. You can see information for the 10 most recent alarms.

To view the run status in the event of an alarm, mark the alarm and press the OK button.

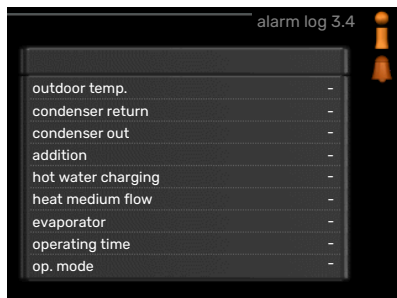
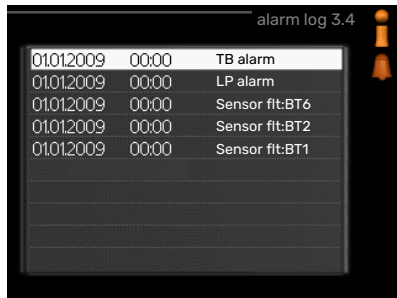

Information about an alarm.

MENU 3.5 - INDOOR TEMP. LOG

Here you can see the average temperature indoors week by week during the past year. The dotted line indicates the annual average temperature.

The average outdoor temperature is only shown if a room temperature sensor/room unit is installed.

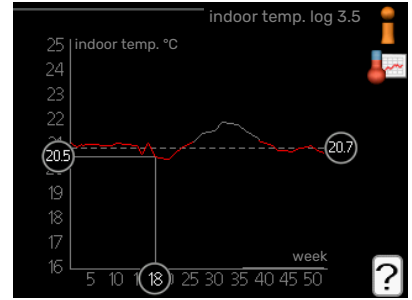

To read off an average temperature

1. Turn the control knob so that the ring on the shaft with the week number is marked.
2. Press the OK button.
3. Follow the grey line up to the graph and out to the left to read off the average indoor temperature at the selected week.
4. You can now select to take read outs for different weeks by turning the control knob to the right or left and read off the average temperature.
5. Press the OK or Back button to exit read off mode.

Adjust the indoor module

OVERVIEW

Sub-menus

For the menu **MY SYSTEM** there are several sub-menus. Status information for the relevant menu can be found on the display to the right of the menus.



plus functions Settings applying to any installed extra functions in the heating system.

op. mode Activation of manual or automatic operating mode. The status information shows the selected operating mode.

my icons Settings regarding which icons in the indoor module's user interface that are to appear on the hatch when the door is closed.

time & date Setting current time and date.

language Select the language for the display here. The status information shows the selected language.

holiday setting Vacation scheduling heating, hot water and ventilation. Status information "set" is displayed if you set a vacation schedule but it is not active at the moment, "active" is displayed if any part of the vacation schedule is active, otherwise it displays " off".

advanced Settings of indoor module work mode.

MENU 4.1 - PLUS FUNCTIONS

Settings for any additional functions installed in VVM 310 can be made in the sub menus.



MENU 4.1.1 - POOL (ACCESSORY IS REQUIRED)

start temp

Setting range: 5.0 - 80.0 °C

Default value: 22.0 °C

stop temperature

Setting range: 5.0 - 80.0 °C

Default value: 24.0 °C

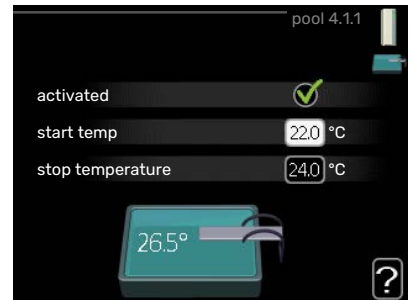

Select whether the pool control is to be activated and within what temperatures (start and stop temperature) pool heating must occur.

When the pool temperature drops below the set start temperature and there is no hot water or heating requirement, VVM 310 starts pool heating.

Untick "activated" to switch off the pool heating.



Caution

The start temperature cannot be set to a value that is higher than the stop temperature.

MENU 4.1.3 - INTERNET

Here you make the settings for connecting VVM 310 via NIBE Uplink, which uses the Internet.

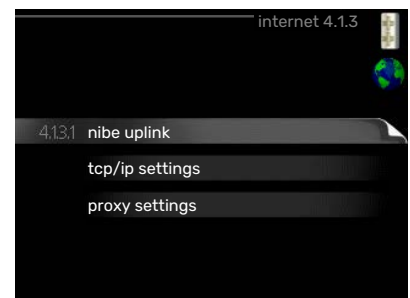

NOTE

For these functions to work the network cable must be connected.

MENU 4.1.3.1 - NIBE UPLINK

Here you can manage the installation's connection to NIBE Uplink (nibeuplink.com) and see the number of users connected to the installation via the internet.



A connected user has a user account in NIBE Uplink , which has been given permission to control and/or monitor your installation.

Request new connection string

To connect a user account on NIBE Uplink to your installation, you must request a unique connection code.

1. Mark "request new connection string" and press the OK button.
2. The installation now communicates with NIBE Uplink to create a connection code.
3. When a connection string has been received, it is shown in this menu at "connection string" and is valid for 60 minutes.

Disconnect all users

1. Mark "switch off all users" and press the OK button.
2. The installation now communicates with NIBE Uplink to release your installation from all users connected via the internet.



NOTE

After disconnecting all users none of them can monitor or control your installation via NIBE Uplink without requesting a new connection string.

MENU 4.1.3.8 - TCP/IP SETTINGS

Here, you can set TCP/IP settings for your installation.

Automatic setting (DHCP)

1. Tick "automatic".
The installation now receives the TCP/IP settings using DHCP.



2. Mark "confirm" and press the OK button.

Manual setting

1. Untick "automatic", you now have access to several setting options.
2. Mark "ip-address" and press the OK button.
3. Enter the correct details via the virtual keypad.
4. Select "OK" and press the OK button.
5. Repeat 1 - 3 for "net mask", "gateway" and "dns".
6. Mark "confirm" and press the OK button.



Caution

The installation cannot connect to the internet without the correct TCP/IP settings. If unsure about applicable settings use the automatic mode or contact your network administrator (or similar) for further information.



TIP

All settings made since opening the menu can be reset by marking "reset" and pressing the OK button.

MENU 4.1.3.9 - PROXY SETTINGS

You can set proxy settings for your installation here.

Proxy settings are used to give connection information to an intermediate server (proxy server)

between the installation

and Internet. These settings are primarily used when the installation connects to the Internet via a company network. The installation supports proxy authentication of the HTTP Basic and HTTP Digest type.

If unsure about applicable settings, contact your network administrator (or equivalent) for further information.

Setting

1. Tick "use proxy" if you do not want to use a proxy.
2. Mark "server" and press the OK button.
3. Enter the correct details via the virtual keypad.
4. Select "OK" and press the OK button.
5. Repeat 1 - 3 for "port", "user name" and "password".
6. Mark "confirm" and press the OK button.

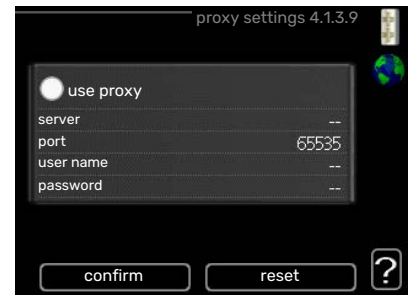

TIP

All settings made since opening the menu can be reset by marking "reset" and pressing the OK button.

MENU 4.1.4 - SMS (ACCESSORY IS REQUIRED)

Make settings for the accessory SMS 40 here.

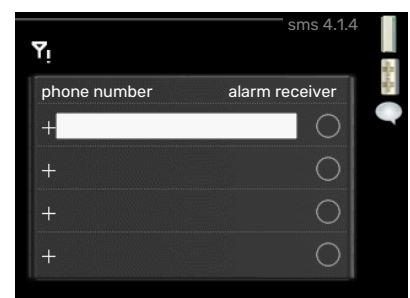

Add the mobile numbers that are to have access to change and receive status information from the indoor module. Mobile numbers must include country code e.g. +46 XXXXXXXX.

If you want to receive an SMS message in the event of the alarm mark the box to the right of the telephone number.

 **NOTE**
Telephone numbers provided must be able to receive SMS messages.

MENU 4.1.5 - SG READY

This function can only be used in mains networks that support the "SG Ready"-standard.

Make settings for the function "SG Ready" here.

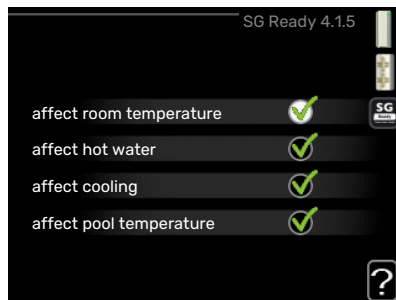

affect room temperature

Here you set whether room temperature should be affected when activating "SG Ready".

With low price mode on "SG Ready" the parallel offset for the indoor temperature is increased by "+1". If a room sensor is installed and activated, the desired room temperature is instead increased by 1 °C.

With over capacity mode on "SG Ready" the parallel offset for the indoor temperature is increased by "+2". If a room sensor is installed and activated, the desired room temperature is instead increased by 2 °C.

affect hot water

Here you set whether the temperature of the hot water should be affected when activating "SG Ready".

With low price mode on "SG Ready", the stop temperature for the hot water is set as high as possible with compressor operation only (immersion heater not permitted).

With over capacity mode of "SG Ready" the hot water is set to "luxury" (immersion heater permitted).

affect cooling (accessory required)

Here you set whether room temperature during cooling operation should be affected when activating "SG Ready".

With low price mode of "SG Ready" and cooling operation the indoor temperature is not affected.

With over capacity mode on "SG Ready" and cooling operation, the parallel offset for the indoor temperature is reduced by "-1". If a room sensor is installed and activated, the desired room temperature is instead reduced by 1 °C.

affect pool temperature (accessory is required)

Here you set whether pool temperature should be affected when activating "SG Ready".

With low price mode on "SG Ready", the desired pool temperature (start and stop temperature) is increased by 1 °C.

With over capacity mode on "SG Ready" the desired pool temperature (start and stop temperature) is increased by 2 °C

 **NOTE**
The function must be connected and activated in your VVM 310.

MENU 4.1.6 - SMART PRICE ADAPTION™

affect room temperature

Setting range: 1 - 10

Factory setting: 5

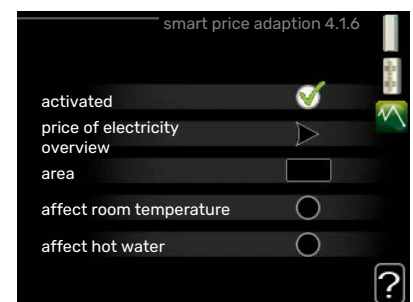

affect hot water

Setting range: 1 - 4

Factory setting: 2

affect pool temperature

Setting range: 1 - 10

Factory setting: 2

affect cooling

Setting range: 1 - 10

Factory setting: 3

area

In this menu you state where the heat pump is located and how great a role the electricity price should play. The greater the value, the greater the effect the electricity price has and the possible savings are larger, but at the same time there is an increased risk of affecting comfort.

price of electricity overview

Here you can obtain information on how the electricity price varies over up to three days.

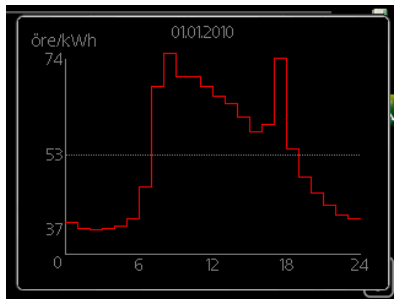

Smart price adaption™ moves the heat pump's consumption over 24 hours to periods with the cheapest electricity tariff, which gives savings for hourly rate based electricity contracts. The function is based on hourly rates for the next 24 hours being retrieved via NIBE Uplink and therefore an internet connection and an account for NIBE Uplink are required.

Deselect "activated" to switch off Smart price adaption™.

MENU 4.1.7 - SMART HOME (ACCESSORY IS REQUIRED)

When you have a smart home system that can speak to NIBE Uplink, by activating the smart home function in this menu you can control the VVM 310 via an app.

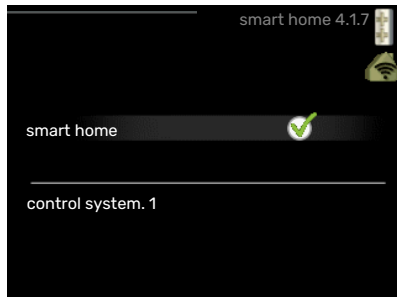

By allowing connected units to communicate with NIBE Uplink, your heating system becomes a natural part of your homesmart home and gives you the opportunity to optimise the operation.



Caution

The smart home function requires NIBE Uplink in order to work.

MENU 4.1.8 - SMART ENERGY SOURCE™

settings
set. price
*CO2 impact**
tariff periods, electricity
tariff per, ext. shunt add
tariff per, ext. step add

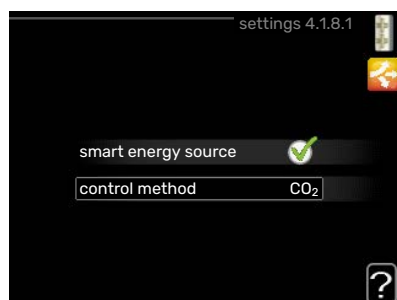
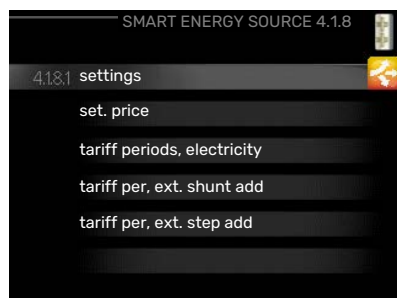

The function prioritises how / to what extent each docked

energy source will be used. Here you can choose if the system is to use the energy source that is cheapest at the time. You can also choose if the system is to use the energy source that is most carbon neutral at the time.

*Select control method "CO₂" under settings to open this menu.

MENU 4.1.8.1 - SETTINGS

smart energy source™
 Setting range:
 Off/On
 Factory setting:
 Off
control method
 Setting range:
 Price / CO₂
 Factory setting:
 Price

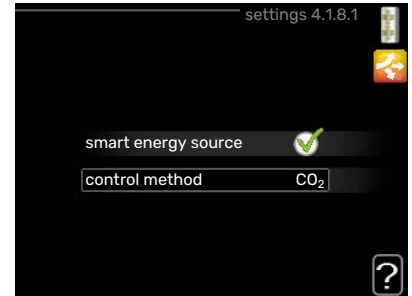

MENU 4.1.8.2 - SET. PRICE

price, electricity
 Setting range:
 spot, tariff, fixed price
 Factory setting:
 fixed price
 Setting range
 fixed price:
 0-100,000*

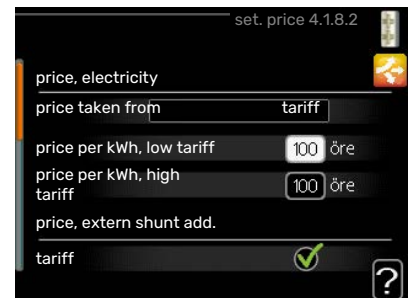

price, extern shunt add.
 Setting range: tariff, fixed price
 Factory setting: fixed price
 Setting range fixed price: 0-100,000*

price, extern step add.
 Setting range: tariff, fixed price
 Factory setting: fixed price
 Setting range fixed price: 0-100,000*

Here you can choose whether the system is to exercise control based on the spot price, tariff control or a set price. The setting is made for each individual energy source. Spot price can only be used if you have an hourly tariff agreement with your electricity supplier.

*The currency varies depending on the country selected.

MENU 4.1.8.3 - CO2 IMPACT

CO2, electricity

Setting range: 0–5

Default value: 2.5

CO2, ext. shunted contr. add.

Setting range: 0–5

Default value: 1

CO2, ext. step contr. add.

Setting range: 0–5

Default value: 1

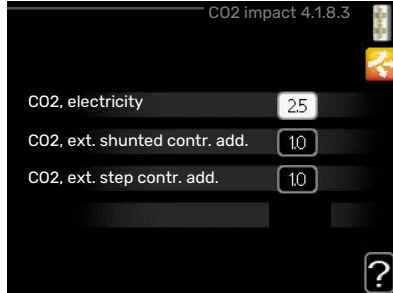

Here, you set the size of the carbon footprint for each energy source.

The carbon footprint is different for different energy sources. For example, the energy from solar cells and wind turbines can be considered carbon dioxide neutral and, therefore, has a low CO₂ impact. Energy from fossil fuels can be considered to have a higher carbon footprint and, therefore, has a higher CO₂ impact.

MENU 4.1.8.4 - TARIFF PERIODS, ELECTRICITY

Here you can use tariff control for the electric additional heat.

Set the lower tariff periods. It is possible to set two different date periods per year. Within these periods,

it is possible to set up to four different periods on weekdays (Monday to Friday) or four different periods on weekends (Saturdays and Sundays).

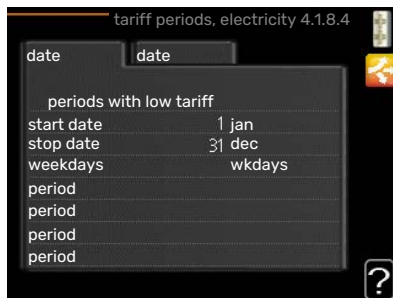

MENU 4.1.8.6 - TARIFF PER, EXT. SHUNT ADD

Here you can use tariff control for the external shunted additional heat.

Set the lower tariff periods. It is possible to set two different date periods per year. Within these periods,



it is possible to set up to four different periods on weekdays (Monday to Friday) or four different periods on weekends (Saturdays and Sundays).

MENU 4.1.8.7 - TARIFF PER, EXT. STEP ADD

Here you can use tariff control for the external step controlled additional heat.

Set the lower tariff periods. It is possible to set two different date periods per year.

Within these periods,

it is possible to set up to four different periods on weekdays (Monday to Friday) or four different periods on weekends (Saturdays and Sundays).



MENU 4.1.10 - SOLAR ELECTRICITY (ACCESSORY REQUIRED)

affect room temperature

Setting range: on/off

Default values: off

affect hot water

Setting range: on/off

Default values: off

affect pool temperature

Setting range: on/off

Factory setting: off

3-phase (EME 10)

Setting range: on/off

Default values: off

prioritise domestic electricity (EME 20)

Setting range: on/off

Default values: off

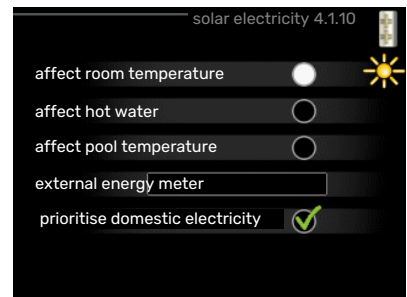

This is where you set which part of your installation (room temperature, hot water temperature, pool temperature) is to benefit from the solar electricity surplus.

When the solar panels produce more electricity than VVM 310 requires, the temperature in the property is adjusted and/or the temperature of the hot water is increased.

EME

In this menu you can also make settings that are specific for your EME.

For EME 10, you enter if it is connected as 3-phase.

For EME 20, you can select whether you want domestic electricity to be prioritised ahead of room temperature and hot water, provided that an external energy meter is connected to VVM 310.

MENU 4.2 - OP. MODE

op. mode
Setting range:
auto, manual, add.
heat only
Default value: auto

functions
Setting range:
compressor, addi-
tion, heating, cool-
ing



The indoor module operating mode is usually set to "auto". It is also possible to set the indoor module to "add. heat only", but only when an addition is used, or "manual" the select yourself what functions are to be permitted.

Change the operating mode by marking the desired mode and pressing the OK button. When an operating mode is selected, it shows what is permitted in the indoor module (crossed out = not permitted) and selectable alternatives to the right. To select selectable functions that are permitted or not you mark the function using the control knob and press the OK button.

Operating mode auto

In this operating mode the indoor module automatically selects what functions are permitted.

Operating mode manual

In this operating mode you can select what functions are permitted. You cannot deselect "compressor" in manual mode.

Operating mode add. heat only

In this operating mode the compressor is not active, only additional heat is used.



Caution

If you choose mode "add. heat only" the compressor is deselected and there is a higher operating cost.



Caution

You cannot change from additional heat only, if you do not have a heat pump connected (see menu 5.2.2).

Functions

"compressor" is the unit that produces heating and hot water for the home. If "compressor" is deselected in auto mode, this is displayed with a symbol in the main menu. You cannot deselect "compressor" in manual mode.

"addition" is the unit that helps the compressor to heat the home and/or the hot water when it cannot manage the entire requirement alone.

"heating" means you obtain heating in the home. You can deselect the function when you do not wish to have the heating on.

"cooling" means that you obtain cooling in the home in hot weather. This alternative requires an accessory for cooling, or for the air/water heat pump to have a built-in function for cooling, and is activated in the menu. You can deselect this function when you do not wish to have cooling in operation.

MENU 4.3 - MY ICONS

You can select what icons should be visible when the door to VVM 310 is closed. You can select up to 3 icons. If you select more, the ones you selected first will disappear. The icons are displayed in the order you selected them.



MENU 4.4 - TIME & DATE

Set time and date, display mode and time zone here.





TIP

Time and date are set automatically if the heat pump is connected to NIBE Uplink. To obtain the correct time, the time zone must be set.

MENU 4.6 - LANGUAGE

Choose the language that you want the information to be displayed in here.

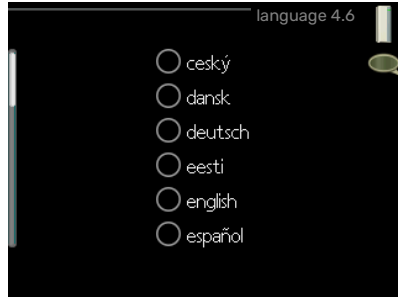

MENU 4.7 - HOLIDAY SETTING

To reduce energy consumption during a holiday you can schedule a reduction in heating and hot water temperature. Cooling, ventilation, pool and solar panel cooling can also be scheduled if the functions are connected.

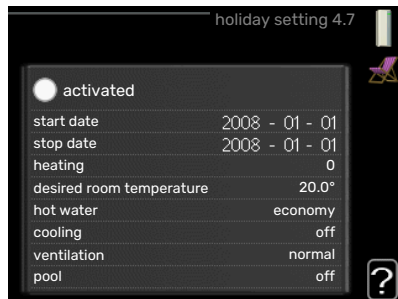

If a room sensor is installed and activated, the desired room temperature (°C) is set during the time period. This setting applies to all climate systems with room sensors.

If a room sensor is not activated, the desired offset of the heating curve is set. One step is usually enough to change the room temperature by one degree, but in some cases several steps may be required. This setting applies to all climate systems without room sensors.

The vacation scheduling starts at 00:00 on the start date and stops at 23:59 on the stop date.



TIP

Stop the holiday setting about a day before your return so that room temperature and hot water have time to return to their usual levels.



TIP

Set the vacation setting in advance and activate just before departure in order to maintain the comfort.

MENU 4.9 - ADVANCED

Menu **advanced** has orange text and is intended for the advanced user. This menu has several sub-menus.

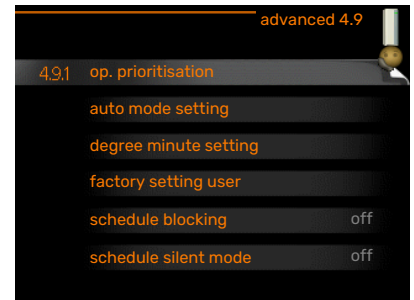

MENU 4.9.1 - OP. PRIORITISATION

op. prioritisation

Setting range: 0 or 10 – 180 min

Default value: 30 min

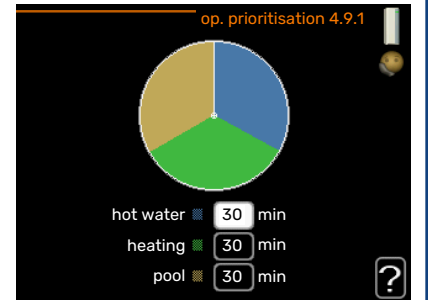

Select here how long the installation should work with each requirement if there are several requirements at the same time. If there is only one requirement, the installation only works with that requirement.

The indicator marks where in the cycle the installation is.

If 0 minutes is selected, this means that the requirement is not prioritised, but will only be activated when there is no other requirement.

MENU 4.9.2 - AUTO MODE SETTING

start cooling (accessory required)

Setting range: -20 – 40 °C

Factory setting: 25

stop heating

Setting range: -20 – 40 °C

Default values: 17

stop additional heat

Setting range: -25 – 40 °C

Factory setting: 5

filtering time

Setting range: 0 – 48 h

Default value: 24 h

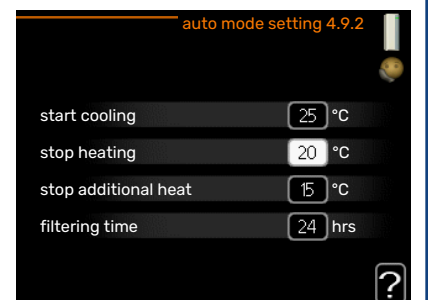

When the operating mode is set to "auto", the indoor module selects when start and stop of additional heat and heat production is permitted, dependent on the average outdoor temperature. If accessories for cooling are present or if the heat pump has the integrated cooling function and it is activated in the menu you can also select the start temperature for cooling.

Select the average outdoor temperatures in this menu.

Caution

It cannot be set "stop additional heat" higher than "stop heating".

filtering time: You can also set the time (filtering time) over which the average temperature is calculated. If you select 0, the current outdoor temperature is used.

MENU 4.9.3 - DEGREE MINUTE SETTING

current value
Setting range:
-3000 - 3000

start compressor
Setting range:
-1000 - -30
Default value: -60

start diff additional heat
Setting range: 100 - 1000
Factory setting: 700

diff. between additional steps
Setting range: 0 - 1000
Factory setting: 100

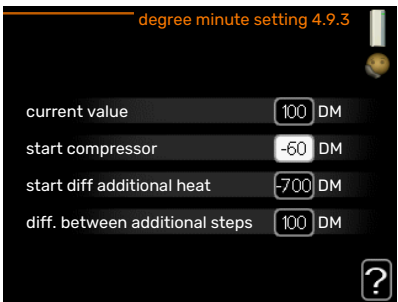

Degree minutes are a measurement of the current heating requirement in the house and determine when the compressor respectively additional heat will start/stop.

Caution

Higher value on "start compressor" gives more compressor starts, which increase wear on the compressor. Too low value can give uneven indoor temperatures.

MENU 4.9.4 - FACTORY SETTING USER

All settings that are available to the user (including advanced menus) can be reset to default values here.

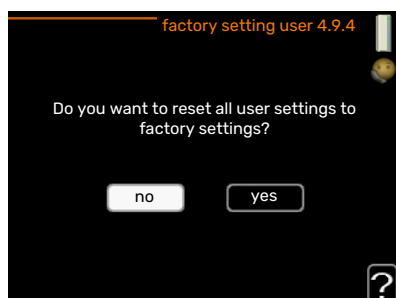

Caution

After factory setting, personal settings such as heating curves must be reset.

MENU 4.9.5 - SCHEDULE BLOCKING

The compressor and/or addition in the indoor module can be scheduled to be blocked for up to two different time periods here.

When scheduling is active the relevant blocking symbol is shown in the main menu on the symbol for the indoor module.

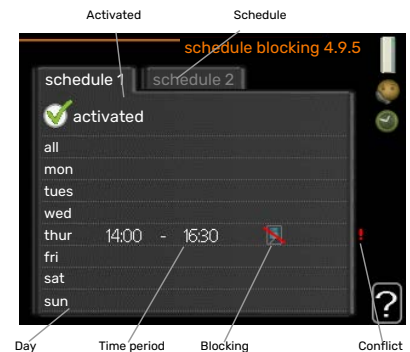

Schedule: The period to be changed is selected here.

Activated: Scheduling for the selected period is activated here. Set times are not affected at deactivation.

Day: Select which day or days of the week the scheduling is to apply to here. To remove the scheduling for a particular day, the time for that day must be reset by setting the start time to the same as the stop time. If the row "all" is used, all days in the period are set according to that row.

Time period: The start and stop time for the selected day for scheduling are selected here.

Blocking: The desired blocking is selected here.

Conflict: If two settings conflict with each other, a red exclamation mark is displayed.



Blocking the compressor in the outdoor module.



Blocking additional heat.

TIP

If you wish to set similar scheduling for every day of the week start by filling in "all" and then changing the desired days.

TIP

Set the stop time earlier than the start time so that the period extends beyond midnight. Scheduling then stops at the set stop time the day after.

Scheduling always starts on the date that the start time is set for.



Caution

Long term blocking can cause reduced comfort and operating economy.

MENU 4.9.6 - SCHEDULE SILENT MODE

Here you can schedule whether the heat pump is to be set to "quiet mode" (the heat pump must support this) for up to two different time periods and two different max. frequencies. In this way, you can reduce the sound during the day and also reduce it further at night.

When scheduling is active the "quiet mode" symbol is shown in the main menu on the symbol for the indoor module.

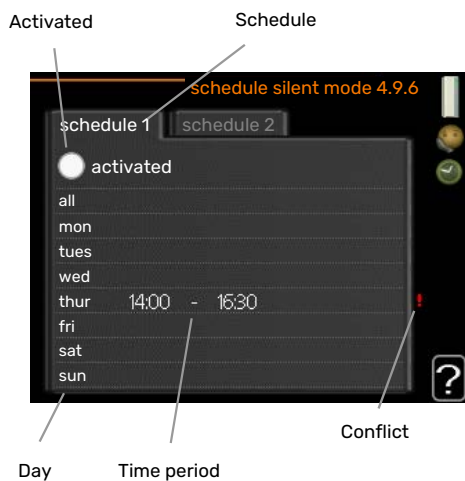

Schedule: The period to be changed is selected here.

Activated: Scheduling for the selected period is activated here. Set times are not affected at deactivation.

Day: Select which day or days of the week the scheduling is to apply to here. To remove the scheduling for a particular day, the time for that day must be reset by setting the start time to the same as the stop time. If the row "all" is used, all days in the period are set according to that row.

Time period: The start and stop time for the selected day for scheduling are selected here.

Conflict: If two settings conflict with each other, a red exclamation mark is displayed.



TIP

If you wish to set similar scheduling for every day of the week start by filling in "all" and then changing the desired days.



TIP

Set the stop time earlier than the start time so that the period extends beyond midnight. Scheduling then stops at the set stop time the day after.

Scheduling always starts on the date that the start time is set for.



Caution

Long term scheduling of "quiet mode" can cause reduced comfort and operating economy.

MENU 4.9.7 - TOOLS

This function ensures that any ice on the fan or fan grille is removed.

In the event of a heavily iced outdoor module, "de-icing fan" may need to be run as a complement to defrosting, which is performed automatically. Activation takes place by ticking "de-icing fan" in the menu, after which de-icing is performed once.



Disturbances in comfort

In most cases, VVM 310 notes a malfunction (a malfunction can lead to disruption in comfort) and indicates this with alarms, and instructions for action, in the display.

Info-menu

All the installation's measurement values are gathered under menu 3.1 in the indoor module's menu system. Examining the values in this menu can often make it easier to identify the source of the fault.

Manage alarm

In the event of an alarm, some kind of malfunction has occurred, which is indicated by the status lamp changing from green continuously to red continuously. In addition, an alarm bell appears in the information window.

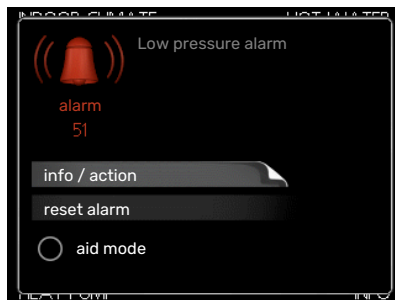

ALARM

In the event of an alarm with a red status lamp, a malfunction has occurred that the indoor module cannot remedy itself. By turning the control knob and pressing the OK button, you can see in the display what type of alarm it is and reset it. You can also choose to set the indoor module to aid mode.

info / action Here you can read what the alarm means and receive tips on what you can do to correct the problem that caused the alarm.

reset alarm In many cases, it is sufficient to select "reset alarm" in order for the product to revert to normal operation. If a green light comes on after selecting "reset alarm", the alarm has been remedied. If a red light is still visible and a menu called "alarm" is visible in the display, the problem causing the alarm still remains. If the alarm initially disappears and then returns, you should contact your installer.

aid mode "aid mode" is a type of emergency mode. This means that the indoor module produces heat and/or hot water, even though there is some kind of problem. This could mean that the heat pump's compressor is not in operation. In this case, the immersion heater produces heat and/or hot water.

Caution

To select aid mode an alarm action must be selected in the menu 5.1.4.

Caution

Selecting "aid mode" is not the same as correcting the problem that caused the alarm. The status lamp will therefore continue to be red.

If the alarm does not reset, contact your installer for suitable remedial action.

Caution

You need the product's (14 digit) serial number for servicing and support.

See chapter Serial number on page 5.

Troubleshooting

If the operational interference is not shown in the display the following tips can be used:

Basic actions

Start by checking the following items:

- The switch's position.
- Group and main fuses of the accommodation.
- The property's earth circuit breaker.

Low hot water temperature or a lack of hot water

- Closed or throttled externally mounted filling valve for the hot water.
 - Open the valve.
- Mixing valve (if there is one installed) set too low.
 - Adjust the mixer valve.
- VVM 310 in incorrect operating mode.
 - Enter menu 4.2. If mode "auto" is selected, select a higher value on "stop additional heat" in menu 4.9.2.
 - If mode "manual" is selected, select "addition".
 - Hot water is produced with VVM 310 in "manual" mode. If there is no air/water heat pump, "addition" must be activated.
- Large hot water consumption.
 - Wait until the hot water has heated up. Temporarily increased hot water capacity (temporary lux) can be activated in menu 2.1.
- Too low hot water setting.
 - Enter menu 2.2 and select a higher comfort mode.
- Low hot water access with the "Smart Control" function active.
 - If the hot water usage has been low, less hot water than normal will be produced. Restart the product.
- Too low or no operating prioritisation of hot water.
 - Contact your installer!
- "Holiday mode" activated in menu 4.7.
 - Enter menu 4.7 and select "Off".

Low room temperature

- Closed thermostats in several rooms.
 - Set the thermostats to max, in as many rooms as possible. Adjust the room temperature via menu 1.1, instead of choking the thermostats.

See the "Saving tips" section for more detailed information about how to best set the thermostats.
- VVM 310 in incorrect operating mode.
 - Enter menu 4.2. If mode "auto" is selected, select a higher value on "stop heating" in menu 4.9.2.

- If mode "manual" is selected, select "heating". If this is not enough, select "addition".
- Too low set value on the automatic heating control.
 - Enter menu 1.1 "temperature" and adjust the offset heating curve up. If the room temperature is only low in cold weather the curve slope in menu 1.9.1 "heating curve" needs adjusting up.
- Too low or no operating prioritisation of heat.
 - Enter menu 4.9.1 and increase the time for when heating is to be prioritised. Note that if the time for heating is increased the time for hot water production is reduced, which can give smaller amounts of hot water.
- "Holiday mode" activated in menu 4.7.
 - Enter menu 4.7 and select "Off".
- External switch for changing room temperature activated.
 - Check any external switches.
- Air in the climate system.
 - Vent the climate system.
- Closed valves to the climate system or heat pump.
 - Open the valves (contact your installer for assistance in finding them).

High room temperature

- Too high set value on the automatic heating control.
 - Enter menu 1.1 (temperature) and reduce the offset heating curve. If the room temperature is only high in cold weather the curve slope in menu 1.9.1 "heating curve" needs adjusting down.
- External switch for changing room temperature activated.
 - Check any external switches.

Low system pressure

- Not enough water in the climate system.
 - Fill the climate system with water and check for leaks. In event of repeated filling, contact the installer.

The air/water heat pump's compressor does not start

- There is no heating or hot water demand, nor cooling demand (accessory is required for cooling).
 - VVM 310 does not call on heating, hot water or cooling.
- Compressor blocked due to the temperature conditions.
 - Wait until the temperature is within the product's working range.
- Minimum time between compressor starts has not been reached.
 - Wait for at least 30 minutes and then check if the compressor has started.
- Alarm tripped.
 - VVM 310 temporarily blocked, see menu 3.2 "Compressor information".

Add. heat only

If you are unsuccessful in rectifying the fault and are unable to heat the house, you can, whilst waiting for assistance, continue running the heat pump in "add. heat only". This means that additional heating only is used to heat the house.

SET THE INSTALLATION TO ADDITIONAL HEAT MODE

1. Go to menu 4.2 op. mode.
2. Mark "add. heat only" using the control knob and then press the OK button.
3. Return to the main menus by pressing the Back button.

Technical data

Detailed technical specifications for this product can be found in the installation manual (nibe.eu).

Glossary

ADDITIONAL HEAT

The additional heat is the heat produced in addition to the heat supplied by the compressor in your heat pump. Additional heaters can be for example, immersion heater, electric heater, solar power system, gas/oil/pellet/wood burner or district heating.

BUFFER VESSEL

A buffer vessel increases the system volume and removes the unwanted temperature variations that can otherwise be sent out on the climate system. This ensures the running of the heat pump and reduces the heat spikes that could otherwise be heard from the climate system.

CALCULATED FLOW LINE TEMPERATURE

The temperature that the indoor module calculates that the heating system requires for an optimum accommodation temperature. The colder the outdoor temperature, the higher the calculated supply temperature.

CIRCULATION PUMP

Pump that circulates liquid in a pipe system.

DISTURBANCES IN COMFORT

Disturbances in comfort are undesirable changes to the hot water/indoor comfort, for example when the temperature of the hot water is too low or if the indoor temperature is not at the desired level.

An operational interruption in the indoor module can sometimes be noticed as disturbances in comfort.

In most cases, the heat pump notes operational interference and indicates this with alarms and shows instructions in the display.

In most cases, the indoor module notes operational interference and indicates this with alarms and shows instructions on how to rectify it in the display.

ELECTRICAL ADDITION

This is the electricity that, for example, an internal immersion heater uses to cover the heating demand that the heat pump cannot manage.

EMERGENCY MODE

A mode that can be selected using the switch in the event of a fault, which means that the indoor module does not run. When the indoor module is in emergency mode, the home is heated using an immersion heater.

FLOW PIPE

The line in which the heated water is transported from the indoor module out to the house's climate system (radiators/heating coils).

HEAT EXCHANGER

Device that transfers heat energy from one medium to another without mixing mediums. Examples of different heat exchangers include evaporators and condensers.

HEATING CURVE

The heating curve determines which heat the indoor module is to produce depending on the temperature outdoors. If a high value is selected, this tells the indoor module that it must supply a lot of heat when it is cold outdoors in order to achieve a warm indoor temperature.

HEATING MEDIUM

Hot liquid, usually normal water, which is sent from the indoor module to the house climate system and makes the accommodation warm. The heating medium also heats the charge coil with the hot water.

HOT WATER COIL

A hot water coil heats the domestic hot water (tap water) in the indoor module with heating water (heating medium).

MIXING VALVE

A valve that mixes the cold water with the hot water leaving the heater.

OUTSIDE SENSOR

A sensor that is located outdoors. This sensor tells the indoor module how hot it is outdoors.

RETURN PIPE

The line in which the water is transported back to the indoor module from the house heating system (radiators/heating coils).

RETURN TEMP

The temperature of the water that returns to the indoor module after releasing the heat energy to the radiators/heating coils.

ROOM SENSOR

A sensor that is located indoors. This sensor tells the indoor module how hot it is indoors.

SHUNT

A valve that mixes the hot water with a small amount of slightly cooler water. There is a shunt in the indoor module that mixes the supply water with the return line so that the heating system reaches the correct temperature.

SHUTTLE VALVE

A valve that can send liquid in two directions. A shuttle valve that enables liquid to be sent to the climate system, when the heat pump produces heating for the house, and to the hot water side, when the heat pump produces hot water.

SUPPLY TEMPERATURE

The temperature of the heated water that the indoor module sends out to the heating system. The colder the outdoor temperature, the higher the supply line temperature becomes.

Contact information

AUSTRIA

KNV Energietechnik GmbH
Gahberggasse 11, 4861 Schörfling
Tel: +43 (0)7662 8963-0
mail@knv.at
knv.at

FINLAND

NIBE Energy Systems Oy
Juurakkotie 3, 01510 Vantaa
Tel: +358 (0)9 274 6970
info@nibe.fi
nibe.fi

GREAT BRITAIN

NIBE Energy Systems Ltd
3C Broom Business Park,
Bridge Way, S41 9QG Chesterfield
Tel: +44 (0)330 311 2201
info@nibe.co.uk
nibe.co.uk

POLAND

NIBE-BIAWAR Sp. z o.o.
Al. Jana Pawla II 57, 15-703 Bialystok
Tel: +48 (0)85 66 28 490
biawar.com.pl

CZECH REPUBLIC

Družstevní závody Dražice - strojírna
s.r.o.
Dražice 69, 29471 Benátky n. Jiz.
Tel: +420 326 373 801
nibe@nibe.cz
nibe.cz

FRANCE

NIBE Energy Systems France SAS
Zone industrielle RD 28
Rue du Pou du Ciel, 01600 Reyrieux
Tél: 04 74 00 92 92
info@nibe.fr
nibe.fr

NETHERLANDS

NIBE Energietechnik B.V.
Energieweg 31, 4906 CG Oosterhout
Tel: +31 (0)168 47 77 22
info@nibenl.nl
nibenl.nl

SWEDEN

NIBE Energy Systems
Box 14
Hannabadsvägen 5, 285 21 Markaryd
Tel: +46 (0)433-27 3000
info@nibe.se
nibe.se

DENMARK

Vølund Varmeteknik A/S
Industrivej Nord 7B, 7400 Herning
Tel: +45 97 17 20 33
info@volundvt.dk
volundvt.dk

GERMANY

NIBE Systemtechnik GmbH
Am Reiherpfahl 3, 29223 Celle
Tel: +49 (0)5141 75 46 -0
info@nibe.de
nibe.de

NORWAY

ABK-Qviller AS
Brobekkveien 80, 0582 Oslo
Tel: (+47) 23 17 05 20
post@abkqviller.no
nibe.no

SWITZERLAND

NIBE Wärmetechnik c/o ait Schweiz AG
Industriepark, CH-6246 Altishofen
Tel. +41 (0)58 252 21 00
info@nibe.ch
nibe.ch

For countries not mentioned in this list, contact NIBE Sweden or check nibe.eu for more information.

NIBE Energy Systems
Hannabadsvägen 5
Box 14
SE-285 21 Markaryd
info@nibe.se
nibe.eu

UHB EN 2235-1 731255

This is a publication from NIBE Energy Systems. All product illustrations, facts and data are based on the available information at the time of the publication's approval.

NIBE Energy Systems makes reservations for any factual or printing errors in this publication.

©2022 NIBE ENERGY SYSTEMS

