



Air/water heat pump

NIBE S2125

NIBE S2125 is an intelligent, inverter-controlled air/water pump. With NIBE indoor modules, it forms a very efficient climate system for your home. NIBE S2125 provides optimised savings as it automatically adapts to your home's output requirements all year around.

The NIBE S2125 has an optimised seasonal performance factor*, which results in low operating costs and high-performance hot water. The working area gives a supply temperature of up to 75°C. At an outdoor temperature down towards -25°C, it still delivers up to 65°C, while the noise level stays low. Available in two power sizes, 8 and 12.

Together with the NIBE S-series indoor module with built-in wifi connection and the possibility of wireless accessories, the S-series is a natural part of your connected home. Smart technology adjusts the indoor climate automatically while you're in complete control from your phone or tablet. Giving high comfort and low energy consumption, while doing nature a favour at the same time.



- **Optimised seasonal performance factor* and low operating costs.**
- **Working range up to 75°C supply temperature and 65°C at an outdoor temperature of -25°C.**
- **New design for low noise level.**

*The NIBE S2125 has a rating of SCOP of 5.0 (Average climate, 35/55 °C) and SCOP of >4.1 (Cold climate, 35/55 °C) in accordance with European standard EN 14825:2018, i.e. the standard for determining the reference seasonal effect level, SCOP. Applies to S2125 -8 and -12.

This is how NIBE S2125 works

Installation method

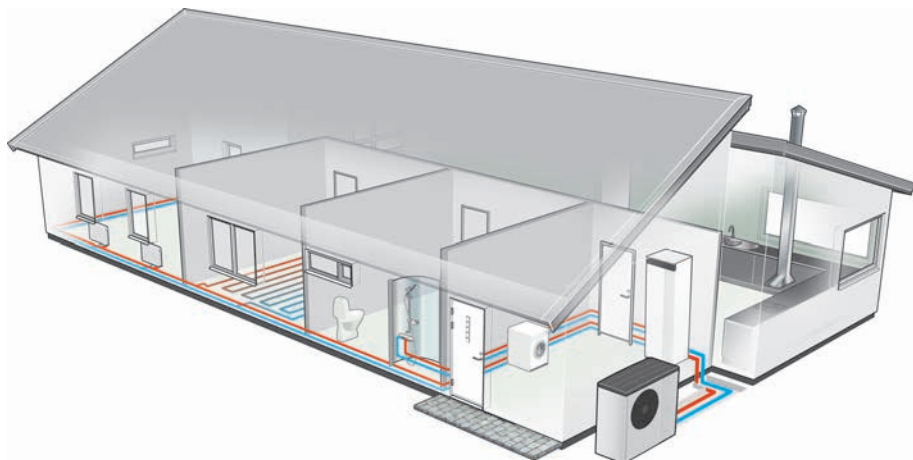

S2125 – a part of your climate system where S2125 is intended to be combined with one of the indoor modules VVM or the control modules SMO.

Together with an indoor module, S2125 creates a complete heating/cooling and hot water unit. Our flexible indoor modules provide efficient heating and high hot water performance. VVM indoor modules are complete with a smart and user-friendly control system, hot water heater, additional heat, self-regulating circulation pump, etc.

The control modules, SMO, offer a flexible system solution that can be easily customised. For systems with SMO, different components such as water heaters, additional heat and other accessories can be selected to suit the installation's requirements.

There is a wide range of system solutions and accessories for NIBE's indoor modules and control modules.

COMPATIBLE INDOOR MODULES (VVM) AND CONTROL MODULES (SMO)

	VVM S320	SMO S40
S2125-8	X	X
S2125-12	X	X

	VVM 225	VVM 310	VVM 500	SMO 20	SMO 40
S2125-8	X	X	X	X	X
S2125-12		X	X	X	X

INDOOR MODULES



VVM S320

Stainless steel, 1x230 V
Part no. 069 198

VVM S320

Enamel, 3x400 V
Part no. 069 206

VVM S320

Copper, 3x400 V
Part no. 069 195



VVM 225

Stainless steel, 1x230 V
Part no. 069 231

VVM 225

Enamel, 3x400 V
Part no. 069 227

VVM 310

Stainless steel, 3x400 V
Part no. 069 430

VVM 500

Stainless steel, 3x400 V
Part no. 069 400

VVM S320

Stainless steel, 3x230 V
Part no. 069 201

VVM S320

Stainless steel, 3x400 V
Part no. 069 196

VVM 225

Stainless steel, 3x230 V
Part no. 069 230

VVM 225

Stainless steel, 3x400 V
Part no. 069 229

VVM 310

Stainless steel, 3x400 V
With integrated EMK 310
Part no. 069 084

CONTROL MODULES

SMO S40

Control module
Part no. 067 654

SMO 20

Control module
Part no. 067 224

SMO 40

Control module
Part no. 067 225

















Principle of operation

Principle of operation with hot water and a heating system.

The heating medium side and the domestic hot water side must be fitted with the necessary safety equipment in accordance with the applicable regulations.

SYMBOL KEY

Symbol	Meaning
	Shut-off valve
	Circulation pump
	Expansion vessel
	Filterball
	Pressure gauge
	Safety valve
	Trim valve
	Reversing valve/shunt
	Indoor module
	Control module
	Air/water heat pump
	Radiator system
	Domestic hot water
	Water heater

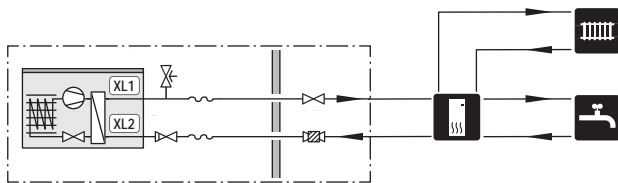

- XL1 Heating medium connection, supply (from S2125)
- XL2 Heating medium connection, return (to S2125)

Good to know about NIBE S2125

Transport

S2125 must be transported and stored vertically.

Ensure that the heat pump cannot fall over during transport.

Check that the heat pump has not been damaged during transport.

LIFT FROM THE STREET TO THE SET UP LOCATION

If the base allows, the simplest thing is to use a pallet truck to move the S2125 to the set up location.

The centre of gravity is offset to one side (see print on the packaging).

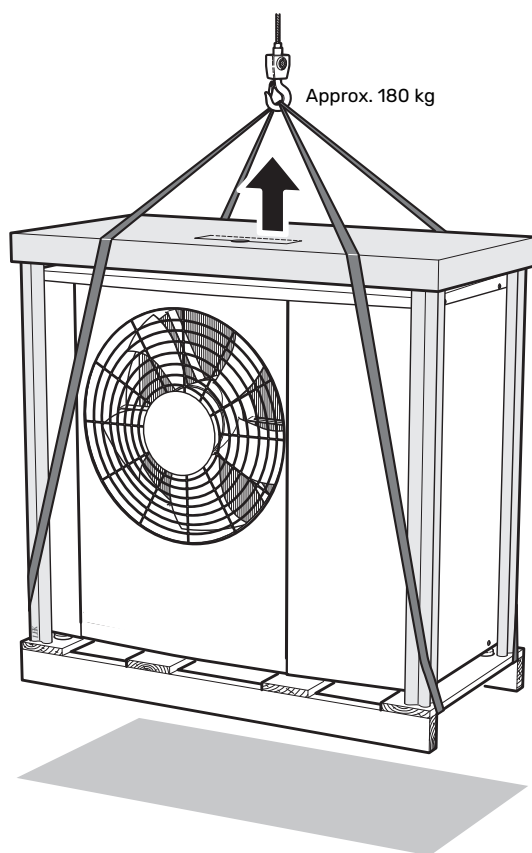

If S2125 needs to be transported across soft ground, such as a lawn, we recommend using a crane truck that can lift it to the installation location. When S2125 is lifted with a crane, the packaging must be untouched.

If a crane vehicle cannot be used the S2125 can be transported on an extended sack truck. S2125 must be taken from its heaviest side and two people are required to lift S2125.

LIFT FROM THE PALLET TO FINAL POSITIONING

Before lifting remove the packaging and the securing strap to the pallet.

Place lifting straps around each machine foot. Lifting from the pallet to the base requires four persons, one for each lifting strap.

Installation and positioning

- Place the heat pump in a suitable location outdoors to prevent any risk of the refrigerant flowing in through ventilation openings, doors or similar openings in the event of a leak. It must also not constitute a hazard to people or property in any other way.
- If the heat pump is placed in a location where any refrigerant leak could accumulate, for example below ground level (in a dip or low-lying recess), the installation must satisfy the same requirements that apply for gas detection and the ventilation of engineering rooms. Requirements regarding sources of ignition must be applied where appropriate.
- Place S2125 outdoors on a solid level base that can take the weight, preferably a concrete foundation. If concrete slabs are used they must rest on asphalt or shingle.
- The lower edge of the evaporator must not be lower than the level of the average local snow depth. The base should be at least 70 mm tall.
- S2125 should not be positioned next to noise sensitive walls, for example, next to a bedroom.
- Also ensure that the placement does not inconvenience the neighbours.
- S2125 must not be placed so that recirculation of the outdoor air is possible. Recirculation entails reduced power and impaired efficiency.
- The evaporator must be sheltered from direct wind / , which negatively affects the defrosting function. Place S2125 protected from wind / against the evaporator.
- Small amounts of condensation water, as well as melt water from defrosting, may be produced. Condensation water must be led off to a drain or equivalent.
- Care must be exercised so that the heat pump is not scratched during installation.

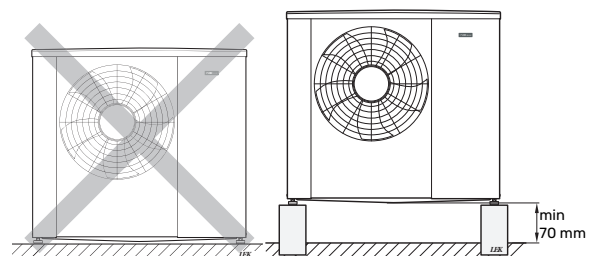

Do not place S2125 directly on the lawn or other non solid surface.

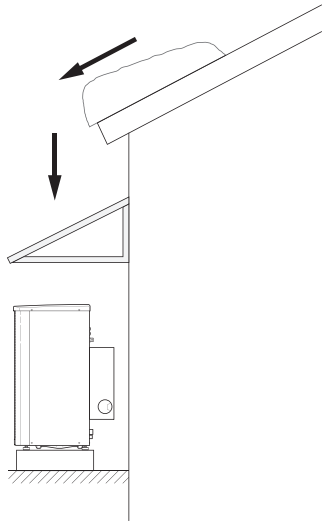

If there is a risk of snow slip from roof, a protective roof or cover must be erected to protect the heat pump, pipes and wiring.

Installation area

The distance between S2125 and the house wall must be at least 350 mm, but not more than 500 mm in locations that are exposed to the wind. The free space above S2125 must be at least 1,000 mm. The free space in front must be at least 1,000 mm for any future servicing.

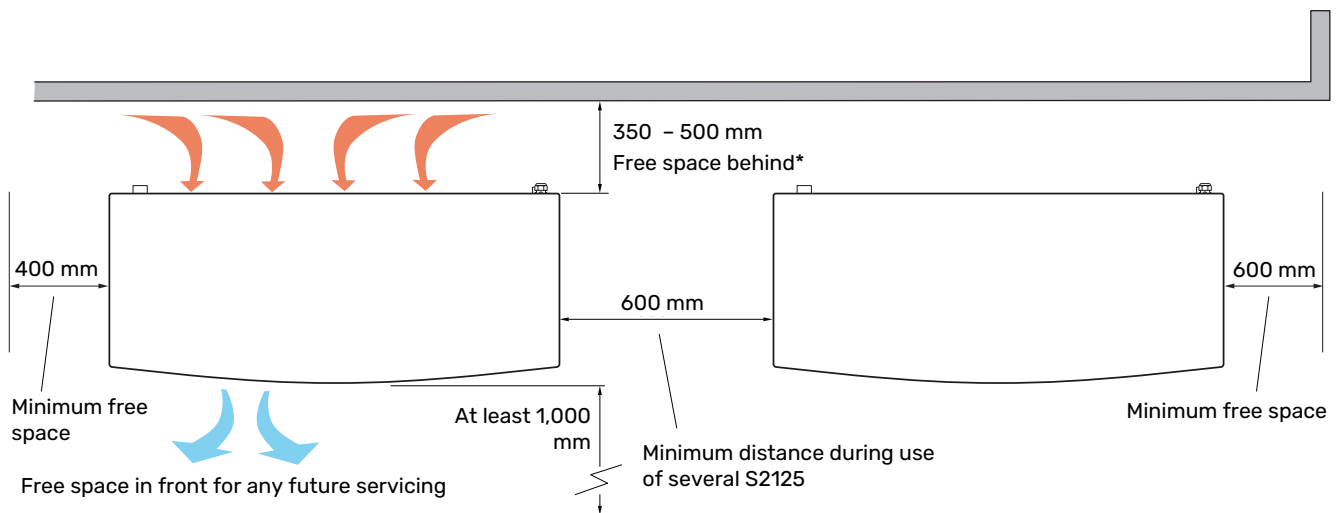

* The space behind must not exceed 500 mm in locations that are exposed to the wind.

Supplied components

Local differences in the enclosed kit may occur. See relevant installer manual for more information.

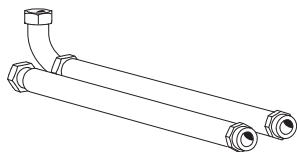

1 x flexible pipe with bend
(WN2)

1 x flexible pipe (WN3)
(Dimensions, flexible pipes
DN25, G1")

4 x gaskets

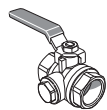

1 x filterball (G1") (QZ2)

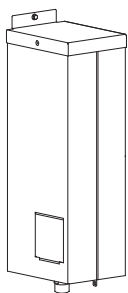

1 x automatic gas separator
(HQ8)

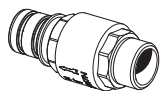

1 x non-return valve (RM1.2)

Installation

Inspection of the installation

Current regulations require the heating installation to be inspected before it is commissioned. The inspection must be carried out by a suitably qualified person and must be documented. The above applies to closed heating systems. If the heat pump is replaced, the installation must be inspected again.

Condensation water trough

The condensate drain pan collects and leads away the condensation water.

It is important for the heat pump's function that the condensation water is led away and that the outlet for the condensation water pipe is positioned so as to prevent damage to the building. Condensation run-off should be checked regularly, especially during the autumn. Clean if necessary.

Pipe with heating cable for draining the condensate drip tray is not included. To ensure the function, the accessory KVR 11 should be used.

- The condensation water (up to 50 litres/24 hrs) that collects in the trough should be routed away by a pipe to an appropriate drain, it is recommended that the shortest outdoor stretch possible is used.
- The section of the pipe that can be affected by frost must be heated by the heating cable to prevent freezing.

Pipe with heating cable for draining the condensation water trough is not included.

To ensure the function, the accessory KVR 11 should be used.

- Route the pipe downward from S2125.
- The outlet of the condensation water pipe must be at frost free depth.
- Use a water trap for installations where air circulation may occur in the condensation water pipe.
- The insulation must seal against the bottom of the condensation water trough.

DRAINAGE OF CONDENSATION

Stone caisson

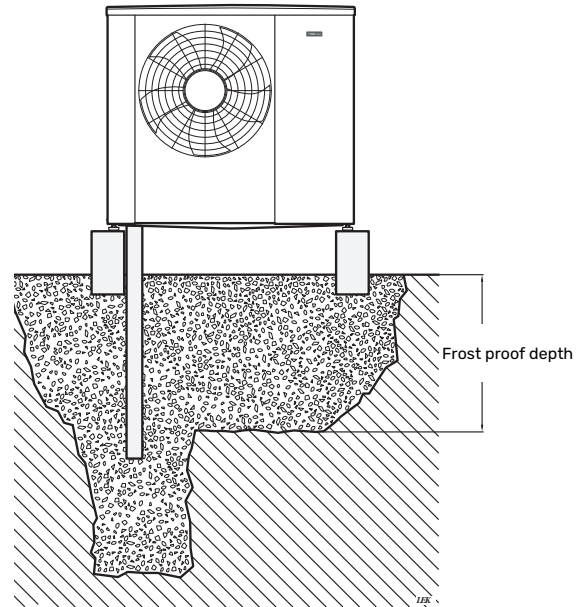

If the house has a cellar the stone caisson must be positioned so that condensation water does not affect the house. Otherwise the stone caisson can be positioned directly under the heat pump.

Gutter drainage

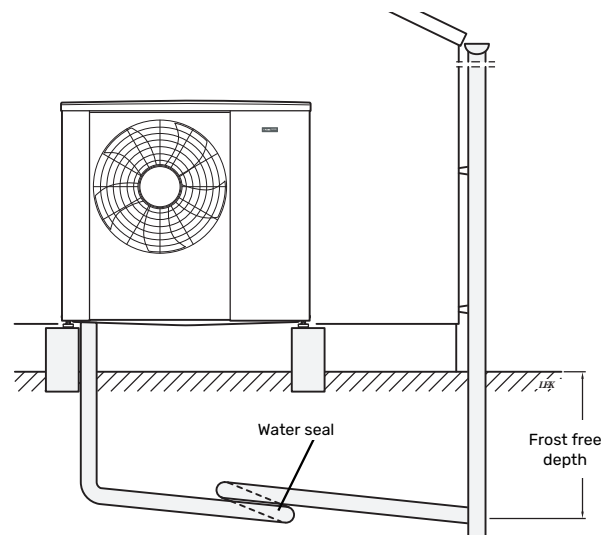

Route the pipe downward from S2125.

The condensation water pipe must have a water seal to prevent air circulation in the pipe.

If none of the recommended alternatives is used good lead off of condensation water must be assured.

Pipe connections

Pipe installation must be carried out in accordance with current norms and directives.

The pipe dimension should not be less than the recommended pipe diameter according to the table. However, each system must be dimensioned individually to manage the recommended system flows.

MINIMUM SYSTEM FLOWS

The installation must be dimensioned to manage at least the minimum defrosting flow at 100% pump operation, see table.

Air/water heat pump	Minimum flow during defrosting (100% pump speed (l/s))	Minimum recommended pipe dimension (DN)	Minimum recommended pipe dimension (mm)
S2125-8 (1x230V)	0.32	25	28
S2125-8 (3x400V)			
S2125-12 (1x230V)			
S2125-12 (3x400V)			

An undersized system can result in damage to the product and lead to malfunctions.

S2125 can only operate up to a return temperature of about 65 °C and an outgoing temperature of about 75 °C from the heat pump.

S2125 is not equipped with shut-off valves on the heating medium side, rather these must be installed to facilitate any future servicing. The return temperature is limited by the return line sensor.

WATER VOLUMES

To avoid short operating times and to enable defrosting, a certain available water volume is required. For the optimum operation of S2125, a minimum available water volume of 120 litres is recommended. This applies separately to heating and cooling systems.

PIPE COUPLING, HEATING MEDIUM

You can find a list of compatible products in the section "Compatible indoor modules (VVM) and control modules (SMO)".

There is a difference between connection to a control module compared with connection to an indoor module.

See the Installer Manual for the indoor module/control module.

The heat pump is vented automatically with the aid of the gas separator (HQ8). The gas separator closes automatically when the valve housing has been vented and filled with liquid.

Install as follows:

- expansion vessel
- pressure gauge
- pressure relief valve
- charge pump
- shut-off valve

To facilitate any future servicing.

- enclosed filterball

Installed before connection "heating medium return" (the lower connection) on the vacuum pump.

- reversing valve.

When connecting to the control module, and if the system is to be able to work with both the climate system and the hot water heater.

- trim valve

When connecting to control module and hot water heater.

The heat pump is vented automatically with the aid of the gas separator (HQ8). The gas separator closes automatically when the valve housing has been vented and filled with liquid.

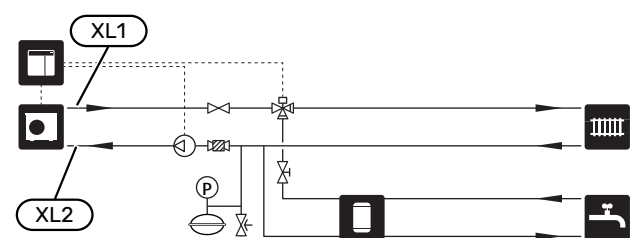

The image shows connection to the control module.

Charge pump

The charge pump (not included in the product) is powered and controlled from the indoor module/control module. It has a built-in frost protection function and, for this reason, must not be switched off when there is a risk of freezing.

At temperatures below +2 °C the charge pump runs periodically, to prevent the water from freezing in the charge circuit. The function also protects against excess temperatures in the charge circuit.

Pressure drop, heating medium side

The diagram shows the pressure drop on the heating medium side, including the gas separator.

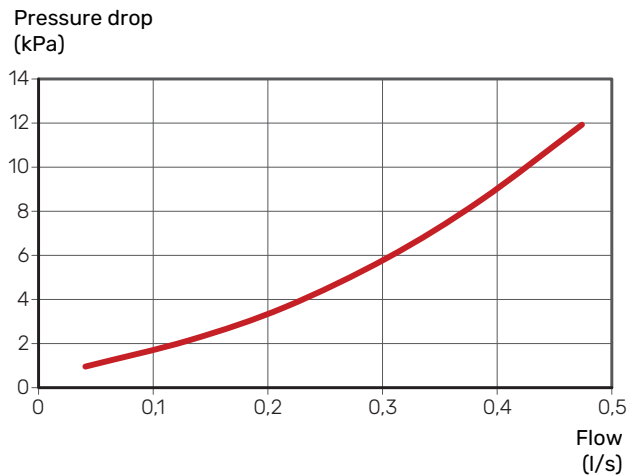

Pipe insulation

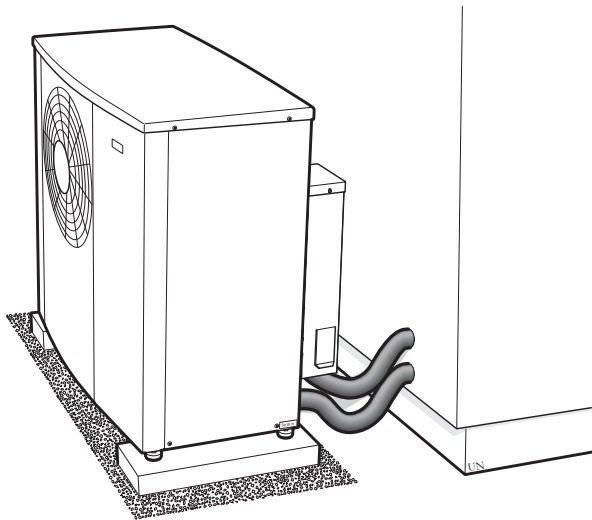

All outdoor pipes must be insulated with at least 19 mm thick pipe insulation.

Installation alternative

S2125 can be connected in several ways. The necessary safety equipment must be installed in accordance with current regulations for all installation options.

See nibe.eu for more detailed installation options.

Electrical connections

- Electrical installation and wiring must be carried out in accordance with national provisions.
- Disconnect S2125 before insulation testing the house wiring.
- If a miniature circuit breaker is used, this must have at least triggering characteristic "C". See section "Technical specifications" in the Installer Manual for S2125.
- If the building is equipped with an RCD, S2125 must be equipped with a separate one.
- The RCD should have a nominal tripping current of no more than 30 mA.
- S2125 must be installed via an isolator switch. The cable area has to be dimensioned based on the fuse rating used. The incoming supply must be 400V 3N~ 50Hz via an electrical distribution unit with fuses. For 230V~ 50Hz, the incoming supply must be 230V~ 50Hz via distribution box with fuses.
- The routing of cables for heavy current and signals should be made out through the cable glands on the heat pump's right-hand side, seen from the front.
- Use a screened cable for communication.
- To prevent interference, sensor cables to external connections must not be laid close to high voltage cables.
- Connect the charge pump to the control module. See where the charge pump is to be connected in the Installer Manual for your control module.

Maintenance

When your heat pump is located outdoors some external maintenance is required.

Insufficient maintenance can cause serious damage to S2125, which is not covered by the guarantee.

Checking grilles and bottom panel on S2125

Check regularly throughout the year that the grille is not clogged by leaves, snow or anything else.

You should be particularly vigilant during windy conditions and/or in the event of snow, as the grille can become blocked.

Also check that the drain holes in the bottom panel are free from dirt and leaves.

Regularly check that condensation is routed away correctly through the condensation pipe. Ask your installer for assistance if required.

KEEP FREE OF SNOW AND ICE

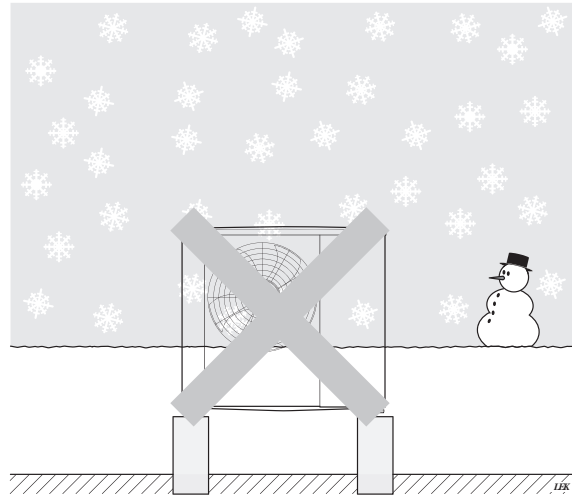

Prevent snow from building up and covering the grilles and drain holes on S2125.

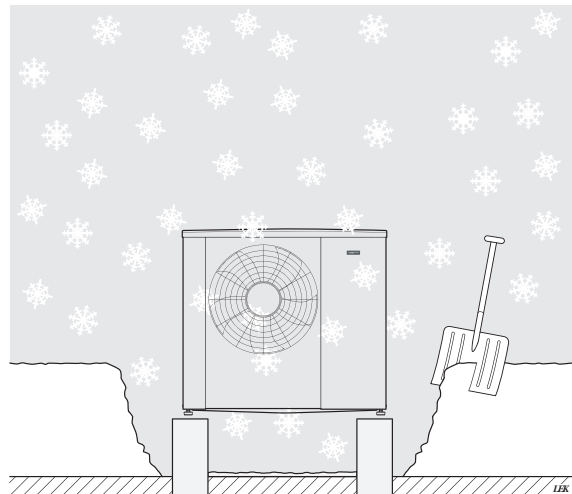

Keep free of snow and/or ice.

Cleaning the outer casing

If necessary the outer casing can be cleaned using a damp cloth.

Care must be exercised so that the heat pump is not scratched when cleaning. Avoid spraying water into the grilles or the sides so that water penetrates into S2125. Prevent S2125 coming into contact with alkaline cleaning agents.

Functions

When connection to NIBE indoor module / control module (VVM / SMO) is ready, you can control your unit via the indoor module / control module.

Control, general

The indoor temperature depends on several different factors. Sunlight and heat emissions from people and household machines are normally sufficient to keep the house warm during the warm seasons. When it gets colder outside, the climate system needs to help heat the house. The colder it is outside, the warmer radiators and underfloor heating systems have to be.

Control of the heat production is performed based on the "floating condensing" principle, which means that the temperature level needed for heating at a specific outdoor temperature is produced based on collected values from the outdoor and supply temperature sensors. The room sensor can also be used to compensate the deviation in room temperature.

Heat production



The supply of heating/cooling to the house is regulated in accordance with the selected heating curve setting (or cooling curve). After adjustment, the correct amount of heat for the current outdoor temperature is supplied. The heat pump's supply temperature will oscillate around the theoretically required value.

OWN CURVE

The indoor module/control module have pre-programmed, non-linear heating curves. It is also possible to create your own defined curve. This is a partially linear curve with a number of break points. You select break points and the associated temperatures.

Hot water production



Hot water charging starts when the temperature has fallen to the set start temperature. Hot water charging stops when the hot water temperature at the hot water sensor has been reached.

For temporary higher hot water demand, there is a function called "More hot water".

For temporary higher hot water demand, there is a function that allows the temperature to be raised temporarily for up to 12 hours or by a one time increase (can be selected in the menu system).

It is also possible to put the installation in holiday mode, which means that the lowest possible temperature is maintained without the risk of freezing.

Additional heat only



The indoor module (VVM), which is connected to S2125, can be used with the additional heat alone (electric boiler) to produce heating and hot water, for example before the outdoor module is installed.

Alarm indications



If there is an alarm, the status lamp lights red on the indoor module's / control module's (HWM / SMO) display. Detailed information, depending on the fault, is shown in the display. An alarm log is created with each alarm, containing a number of temperatures, times and operating status.

The display



The indoor module / control module (HWM / SMO) is controlled using a clear and easy-to-use display.

Instructions, settings and operational information are shown on the display. You can easily navigate between the different menus and options to set the comfort or obtain the information you require.

Visit myuplink.com and click the "Software" tab to download the latest software for your installation.

myUplink



With myUplink you can control the installation – where and when you want. In the event of any malfunction, you receive an alarm directly to your e-mail or a push notification to the myUplink app, which allows you to take prompt action.

Visit myuplink.com for more information.

SPECIFICATION

You need the following in order for myUplink to be able to communicate with your system:

- wireless network or network cable
- Internet connection
- account on myuplink.com

We recommend our mobile apps for myUplink.

RANGE OF SERVICES

myUplink gives you access to various levels of service. The base level is included and, apart from this, you can choose two premium services for a fixed annual fee (the fee varies depending on the functions selected).

Service level	Basic	Premium extended history	Premium change settings
Viewer	X	X	X
Alarm	X	X	X
History	X	X	X
Extended history	-	X	-
Manage	-	-	X

MOBILE APPS FOR MYUPLINK

The mobile apps can be downloaded free of charge from where you usually download your mobile apps. Logging into the mobile app is performed using the same account details as on myuplink.com.

NIBE SMART PRICE ADAPTION™



Smart Price Adaption is not available in all countries. Contact your NIBE dealer for more information.

Smart Price Adaption adjusts the heat pump's consumption according to the time of day that electricity prices are lowest. This allows for savings, provided that the hourly rate subscription has been signed with the electricity supplier.

The function is based on hourly rates for the coming day being downloaded via myUplink. To use the function, an Internet connection and account on myUplink are necessary.

SMART HOME

When you have a smart home system that can communicate with myUplink, you can control the installation via an app by activating the "smart home" function.

By allowing connected units to communicate with myUplink, your heating system becomes a natural part of your homesmart home and gives you the opportunity to optimise the operation.

Remember that the "smart home" function requires myUplink in order to work.

NIBE SMART ENERGY SOURCE™



Smart Energy Source™ prioritises how / to what extent each docked energy source will be used.

Here you can choose if the system is to use the energy source that is cheapest at the time. You can also choose if the system is to use the energy source that is most carbon neutral at the time.

Technical data

Dimensions

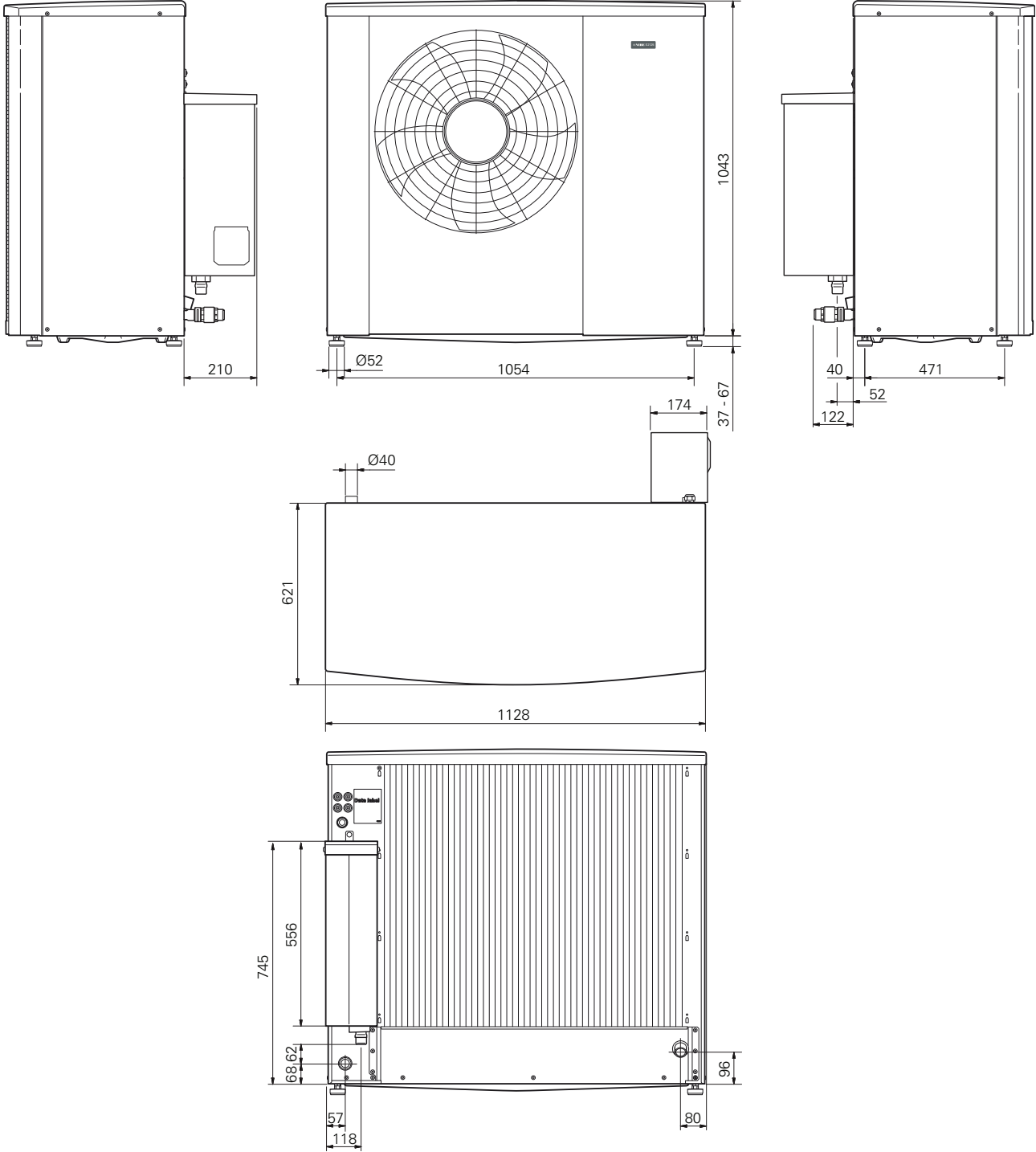

Sound levels

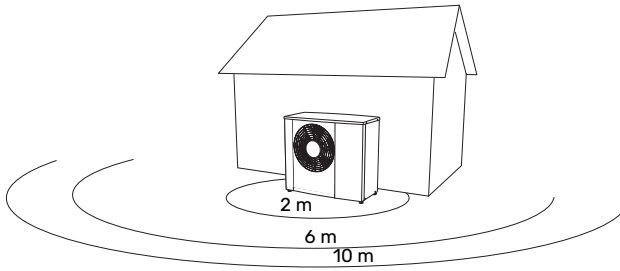

S2125 is usually placed next to a house wall, which gives a directed sound distribution that has to be taken into consideration. Accordingly, when setting up, you should always attempt to select the side that faces the least sound-sensitive neighbouring area.

The sound pressure levels are further affected by walls, bricks, differences in ground level, etc and should therefore only be seen as guide values.

		Sound power ¹	Sound pressure at distance (m) ²									
			1	2	3	4	5	6	7	8	9	10
S2125-8	Nominal sound value	49	44	38	34.5	32	30	28.5	27	26	25	24
	Max. sound value	55	50	44	40.5	38	36	34.5	33	32	31	30
	Max. sound value, silent mode	50	45	39	35.5	33	31	29.5	28	27	26	25
S2125-12	Nominal sound value	49	44	38	34.5	32	30	28.5	27	26	25	24
	Max. sound value	59	54	48	44.5	42	40	38.5	37	36	35	34
	Max. sound value, silent mode	54	49	43	39.5	37	35	33.5	32	31	30	29

¹ Sound power level, $L_W(A)$, according to EN12102

² Sound pressure calculated according to directivity factor $Q=4$

Technical specifications

WORKING RANGE, HEATING

Supply temperature (°C)

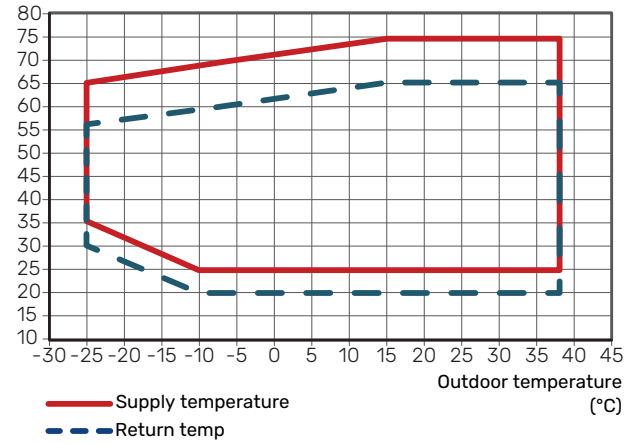

WORKING RANGE, COOLING

Supply temperature (°C)

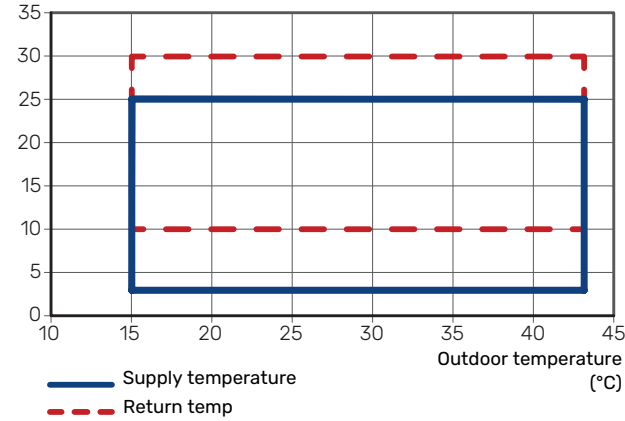

During shorter time it is allowed to have lower working temperatures on the water side, e.g. during start up.

POWER DURING HEATING OPERATION

Maximum and minimum capacity during continuous operation. Defrosting is not included.

S2125-8

Heating output (kW)

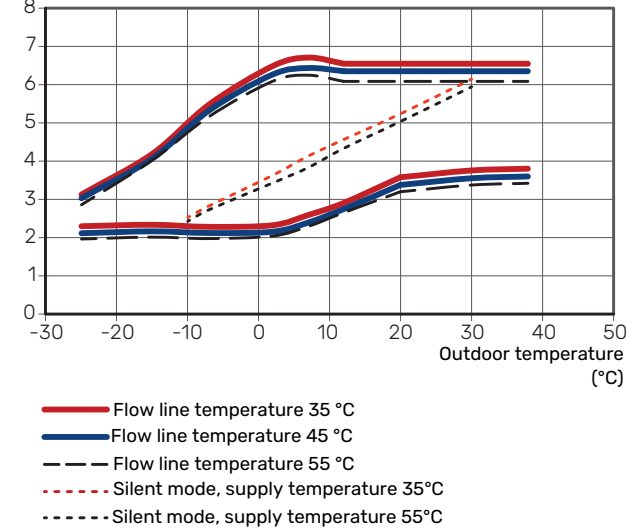

S2125-12

Heating output (kW)

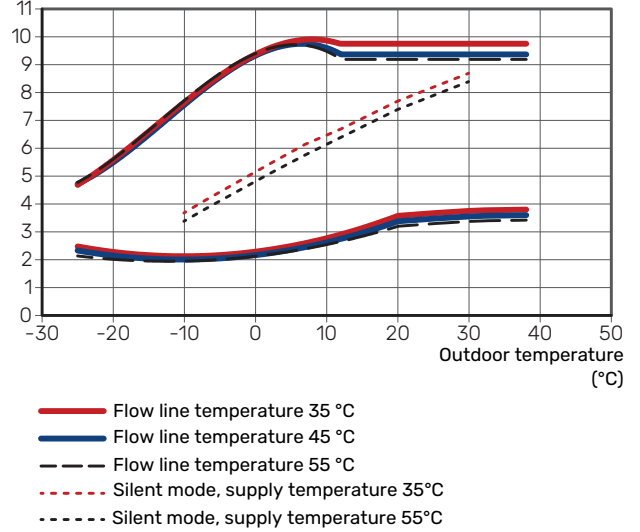

POWER DURING COOLING OPERATION

Maximum and minimum capacity during continuous operation.

Cooling output
(kW)

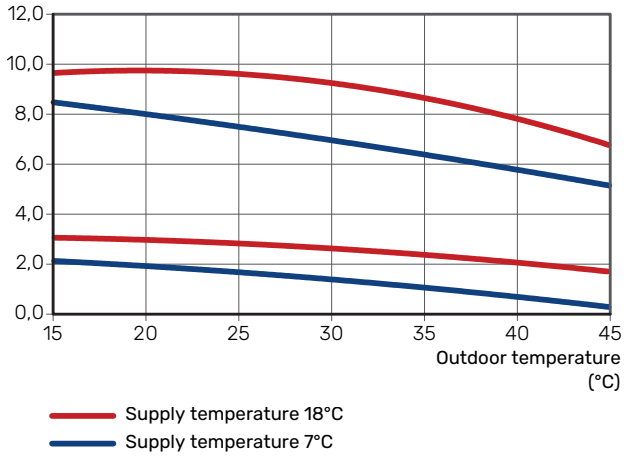

S2125		8	12	8	12
Voltage		1 x 230 V	1 x 230 V	3 x 400 V	3 x 400 V
Output data according to EN 14 511, partial load¹					
Heating	-7 / 35 °C	4.72 / 1.72 / 2.82	7.23 / 2.73 / 2.65	4.72 / 1.72 / 2.82	7.23 / 2.73 / 2.65
Capacity / power input / COP (kW/kW/-) at nominal flow	2 / 35 °C	3.20 / 0.72 / 4.44	3.67 / 0.85 / 4.33	3.20 / 0.72 / 4.44	3.67 / 0.85 / 4.33
	2 / 45 °C	2.95 / 0.87 / 3.39	3.46 / 1.02 / 3.40	2.95 / 0.87 / 3.39	3.46 / 1.02 / 3.40
Outdoor temp. / Supply temp.	7 / 35 °C	3.15 / 0.69 / 5.18	3.67 / 0.70 / 5.21	3.15 / 0.69 / 5.18	3.67 / 0.70 / 5.21
	7 / 45 °C	2.97 / 0.76 / 3.90	3.35 / 0.85 / 3.91	2.97 / 0.76 / 3.90	3.35 / 0.85 / 3.91
	35 / 7 °C	6.69 / 2.41 / 2.77	6.69 / 2.41 / 2.77	6.69 / 2.41 / 2.77	6.69 / 2.41 / 2.77
Cooling	35 / 18 °C	8.68 / 2.60 / 3.34	8.68 / 2.60 / 3.34	8.68 / 2.60 / 3.34	8.68 / 2.60 / 3.34
Capacity / power input / EER (kW/kW/-) at maximum flow					
Outdoor temp. / Supply temp.					
SCOP according to EN 14825					
Nominal heat output (P _{designh}) average climate 35 °C / 55 °C (Europe)	kW	5.33 / 5.30	6.80 / 7.60	5.33 / 5.30	6.80 / 7.60
Nominal heat output (P _{designh}) cold climate 35 °C / 55 °C	kW	5.40 / 5.20	8.40 / 8.40	5.40 / 5.20	8.40 / 8.40
Nominal heat output (P _{designh}) warm climate 35 °C / 55 °C	kW	5.50 / 5.20	7.00 / 7.45	5.50 / 5.20	7.00 / 7.45
SCOP average climate, 35 °C / 55 °C (Europe)		5.00 / 3.70	5.00 / 3.80	5.00 / 3.70	5.00 / 3.80
SCOP cold climate, 35 °C / 55 °C		4.10 / 3.20	4.20 / 3.40	4.10 / 3.20	4.20 / 3.40
SCOP warm climate, 35 °C / 55 °C		6.30 / 4.50	6.30 / 4.60	6.30 / 4.50	6.30 / 4.60
Energy rating, average climate²					
The product's room heating efficiency class 35 °C / 55 °C ³		A+++ / A++	A+++ / A+++	A+++ / A++	A+++ / A+++
The system's room heating efficiency class 35 °C / 55 °C ⁴		A+++ / A+++			
Electrical data					
Rated voltage		230 V - 50 Hz	230 V - 50 Hz	400 V 3N - 50 Hz	400 V 3N - 50 Hz
Max. power, fan	W	30	50	30	50
Fuse	A _{rms}	16	20	6	10
Enclosure class		IP24			
Refrigerant circuit					
Type of refrigerant		R290			
GWP refrigerant		3			
Volume	kg	0.8			
Type of compressor		Rotary compressor			
CO ₂ -equivalent (The cooling circuit is hermetically sealed.)	t	0.0024			
Airflow					
Max airflow	m ³ /h	2,400	2,950	2,400	2,950
Working area					
Min./max. air temperature, heating	°C	-25 / 38			
Min./max. air temperature, cooling	°C	15 / 43			
Heating medium circuit					
Max system pressure heating medium	MPa	0.45 (4.5)			
Cut-off pressure, heating medium	MPa	0.25 (2.5)			
Recommended flow interval, heating operation	l/s	0.08 - 0.32	0.12 - 0.48	0.08 - 0.32	0.12 - 0.48
Min. design flow, defrosting (100% pump speed)	l/s	0.32			
Min./max. HM temp, continuous operation	°C	26 / 75			
Connection heating medium S2125		G1" external thread			
Connection heating medium flex pipe		G1" external thread			
Min. recommended pipe dimension (system)	DN (mm)	25 (28)			
Dimensions and weight					
Width	mm	1,140			
Depth	mm	831			
Height	mm	1,080			
Weight	kg	163	163	179	179
Miscellaneous					
Part no.		064 220	064 218	064 219	064 217

¹ Power statements including defrosting according to EN 14511 at heating medium supply corresponding to DT=5 K at 7 / 45.

² The reported efficiency of the package also takes the controller into account. If an external supplementary boiler or solar heating is added to the package, the overall efficiency of the package should be recalculated.

³ Scale for the product's room heating efficiency class A++ to G. Control module model SMO S

4 Scale for the system's room heating efficiency class A+++ to G. Control module model SMO S

Accessories

Detailed information about the accessories and complete accessories list available at nibe.eu.

Not all accessories are available on all markets.

Condensation water pipe

Condensation water pipe, different lengths.

KVR 11-10

1 metres
Part no. 067 823



KVR 11-30

3 metres
Part no. 067 824

KVR 11-60

6 metres
Part no. 067 825

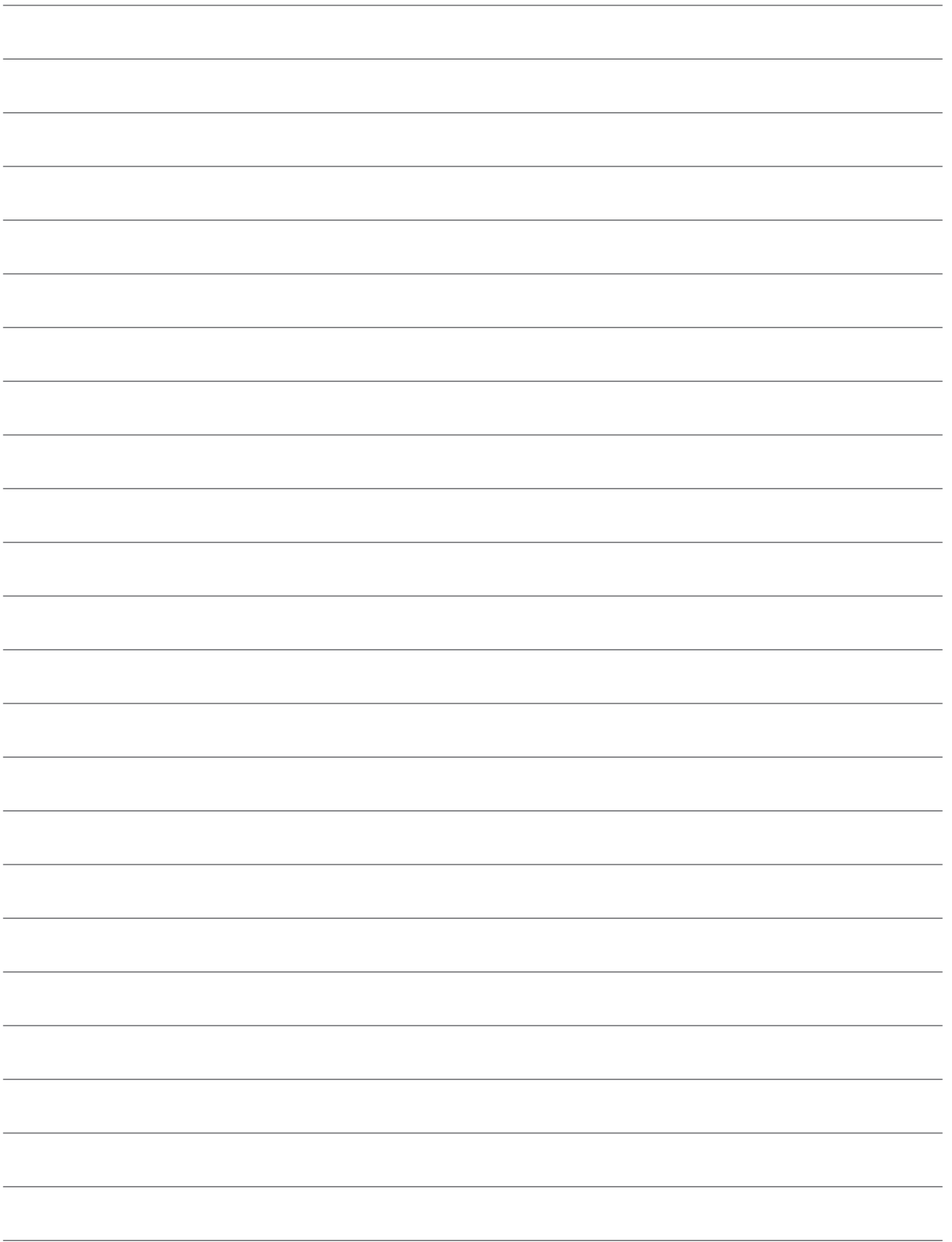

Sustainable energy solutions since 1952

NIBE has been manufacturing energy-efficient and sustainable climate solutions for your home for 70 years. It all began in Markaryd, in the southern Swedish province of Småland, and we recognise our Nordic heritage by utilising the power of nature. We combine renewable energy with smart technology to offer efficient solutions, allowing us to work together to create a more sustainable future.

Regardless of whether it is a chilly winter's day or a warm afternoon in the summer sun, we need a balanced indoor climate that allows us to enjoy a comfortable life, whatever the weather. Our extensive range of products supply your home with cooling, heating, ventilation and hot water, making it possible for you to create a pleasant indoor climate with little impact on the environment.

NIBE Energy Systems
Box 14, SE-285 21 Markaryd
nibe.eu



This product sheet is a publication from NIBE Energy Systems. All product illustrations, facts and data are based on current information at the time of the publication's approval. NIBE Energy Systems makes reservations for any factual or printing errors in this product sheet.